



POWERSPORTS CATALOG



CYLINDER SLEEVES & ACCESSORIES



MOTORCYCLE | ATV & UTV | WATERCRAFT



MANUFACTURER OF QUALITY CYLINDER SLEEVES

TRACTORS

COMPRESSOR

TRUCK

AUTOMOTIVE

MARINE

MOTORCYCLE

ATV/UTV

WATERCRAFT

SNOWMOBILE

CUSTOM

HI-PERFORMANCE



L.A. SLEEVE CO. founded in 1945 has been producing cast iron chrome-moly alloy cylinder sleeves and liners for all engine repair markets. Currently L.A. SLEEVE CO. manufactures cylinder sleeves for Motorcycle, ATV, UTV, Watercraft, Snowmobile, Marine, Automotive, Truck and Tractor markets. A family owned business for four generations, L.A. SLEEVE CO. provides its customers with expertise in engineering, sleeve design and installation.



TABLE OF CONTENTS

<p>Technical Guide.....2</p> <p>Engine & Shop Services3</p> <p>Product Lines4</p> <p>MOTORCYCLE OFFROAD ENGINE PARTS</p> <p>Gas Gas 2-Stroke6</p> <p>Gas Gas 4-Stroke8</p> <p>Honda 2-Stroke10</p> <p>Honda 4-Stroke24</p> <p>Husqvarna 2-Stroke42</p> <p>Husqvarna 4-Stroke48</p> <p>Kawasaki 2-Stroke56</p> <p>Kawasaki 4-Stroke76</p> <p>KTM 2-Stroke86</p> <p>KTM 4-Stroke100</p> <p>Suzuki 2-Stroke110</p> <p>Suzuki 4-Stroke122</p> <p>Yamaha 2-Stroke130</p> <p>Yamaha 4-Stroke144</p> <p>DIRT BIKE SLEEVES</p> <p>ATK158</p> <p>AJS158</p> <p>BSA158</p> <p>Bultaco158</p> <p>Cagiva158</p> <p>Can-Am158</p> <p>CZ158</p> <p>Fantic158</p> <p>Gas Gas158</p> <p>Harley-Davidson158</p> <p>Honda158</p> <p>Husaberg159</p> <p>Husqvarna159</p> <p>Indian160</p> <p>Italjet160</p> <p>Kawasaki160</p> <p>KTM162</p> <p>Maico163</p> <p>M-Star163</p> <p>Montesa163</p> <p>Moto-Villa163</p> <p>Ossa163</p> <p>Puch163</p> <p>Sachs163</p> <p>Suzuki163</p> <p>TM164</p> <p>Yamaha164</p> <p>Zundapp165</p>	<p>ALL PURPOSE SLEEVES166</p> <p>VINTAGE STREET BIKE SLEEVES</p> <p>Ariel168</p> <p>BMW168</p> <p>BSA168</p> <p>Ducati168</p> <p>Enfield168</p> <p>Harley-Davidson168</p> <p>Honda168</p> <p>Indian168</p> <p>Jawa168</p> <p>Kawasaki169</p> <p>Laverda169</p> <p>Matchless169</p> <p>Moto-Guzzi169</p> <p>Norton169</p> <p>Suzuki169</p> <p>Triumph169</p> <p>Velocette169</p> <p>Westlake169</p> <p>Yamaha169</p> <p>STREET BIKE SLEEVES</p> <p>Aprilia170</p> <p>BMW170</p> <p>Cagiva170</p> <p>Ducati170</p> <p>Harley-Davidson170</p> <p>Honda170</p> <p>Kawasaki171</p> <p>KTM172</p> <p>Laverda172</p> <p>Moto-Guzzi172</p> <p>Suzuki172</p> <p>Yamaha173</p> <p>ATV/UTV ENGINE PARTS</p> <p>Arctic Cat176</p> <p>Bombardier Can-Am182</p> <p>Honda 2-Stroke188</p> <p>Honda Pro Cross 2-Stroke190</p> <p>Honda 4-Stroke194</p> <p>Kawasaki 2-Stroke204</p> <p>Kawasaki 4-Stroke206</p> <p>KTM214</p> <p>KYMCO214</p> <p>Polaris 2-Stroke216</p> <p>Polaris 4-Stroke218</p> <p>Suzuki 2-Stroke228</p> <p>Suzuki 4-Stroke230</p> <p>Yamaha 2-Stroke236</p> <p>Yamaha 4-Stroke238</p>	<p>ATV/UTV CYLINDER REBUILD KITS250</p> <p>PERSONAL WATERCRAFT ENGINE PARTS</p> <p>Honda252</p> <p>Kawasaki252</p> <p>Sea Doo255</p> <p>Yamaha256</p> <p>ACCESSORIES</p> <p>Shindy Dirt Bike Carb Rebuild Kits260</p> <p>Shindy ATV Carburetor Rebuild Kits262</p> <p>Unibat Motorcycle Batteries265</p> <p>Unibat ATV UTV Batteries270</p> <p>Vertex Complete Engine Rebuild Kits273</p> <p>TECHNICAL</p> <p>Pro-X Con Rod Dimension Charts276</p> <p>Piston Pin Bearings278</p> <p>Big End Bearings279</p> <p>Big End Pins279</p> <p>Crankshaft Bearings280</p> <p>Crankshaft Oil Seal Dimension Chart281</p> <p>Crankshaft Oil Seals282</p> <p><i>Honda</i>282</p> <p><i>Kawasaki</i>282</p> <p><i>Suzuki</i>283</p> <p><i>Yamaha</i>284</p> <p><i>Polaris</i>285</p> <p><i>Sea Doo</i>285</p> <p>ProX/OEM Piston Replacement Rings286</p> <p>Cylinder Sleeve Installation Procedures290</p> <p>Custom Cylinder Sleeves293</p> <p>Custom Cylinder Sleeve Order Form292</p> <p>Job Order Form – 2-Stroke294</p> <p>Job Order Form – 4-Stroke295</p> <p>L.A. Sleeve Terms & Conditions296</p> <p>L.A. Sleeve Limited Warranty296</p>
---	--	--

SLEEVES:

Los Angeles Sleeve Co. manufactures cast iron cylinder sleeves for all popular makes and models. Engine rebuilders find they can rely on the quality and workmanship of LASCO cylinder sleeves, and their use saves them time and money. The castings used in the manufacture of these sleeves are made from an iron alloy and hardness specifically formulated for cylinder sleeves, which insures ease in installation, trouble free boring and a dependable long life engine.

Centerless grinding of outside diameters of LASCO sleeves provides for perfect roundness and exact size which is controlled by rigid inspection of one-half thousandth of an inch. We invite comparison of our sleeves with other leading makes for size, roundness and finish.

Each cylinder sleeve is designed to best suit its designated cylinder. Three concepts are integrated in the designing and manufacturing of a sleeve:

1. The retained strength of a cylinder after the sleeve is installed.
2. Ease of installation for the rebuilder.
3. The ability to bore to the maximum amount of oversize pistons available.

The TYPE column, next to the sleeve part number, will help the rebuilder identify the cylinder that is to be sleeved.

The TYPE column designation will also help the rebuilder to determine the proper installation procedure.

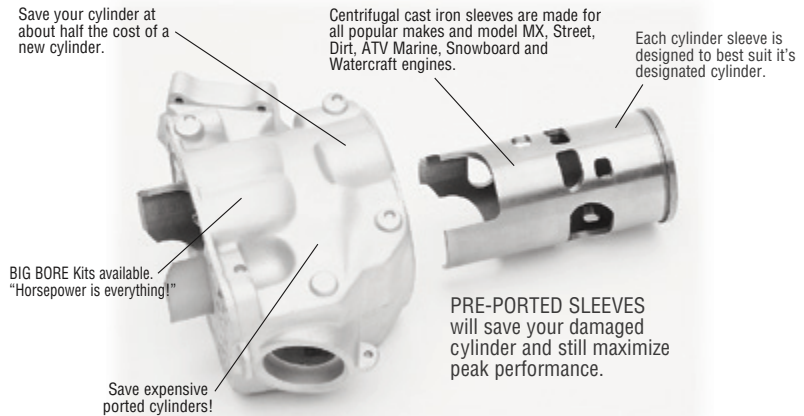

TYPE COLUMN CODE EXPLANATIONS:

- AC:** Original cylinder bore is alloy-chrome plated, Nikasil, or electrofused. The cylinder must be bored to accept the new cylinder sleeve.
- CS:** Original block has a cast-in sleeve liner in the cylinder. The cylinder must be bored out to accept the new cylinder sleeve. The cast-in liner will be bored completely out of the cylinder. Do not try to push out the cast-in liner, cylinder damage may be the result.
- CI:** Original block has a cast-in liner in the cylinder. The cylinder must be bored to accept the new cylinder sleeve. When using a CI style sleeve the cast-in liner will not be completely removed. The sleeve is designed to insert into the iron lined cylinder.
- RS:** Original block has a replacement sleeve. Heat the cylinder to remove the sleeve. Reheat the cylinder to install the new cylinder sleeve.
- CC:** Original barrel is cast-iron. The cylinder must be bored to accept the new cylinder sleeve.
- L:** Limited inventory available. Once inventory of this part number is depleted the sleeve will be made to order. Call for inventory status and/or delivery lead times.
- MO:** Sleeve is made to order. Limited inventory may be in stock. Call for inventory status and/or delivery lead times.
- NA:** This sleeve part number is no longer produced and not available for production.
- BB:** Big Bore Sleeve may require special machining and/or machining of cases or cylinder head.



ENGINE & SHOP SERVICES

SLEEVING... STILL THE SOLUTION!

Re-sleeving worn or seized cylinders and cylinder blocks with cylinder sleeve liners manufactured by L.A. Sleeve Co. continues to be the solution for riders, racer, and engine builders everywhere. Our top quality cylinder sleeves, four-stroke and two-stroke, have proven to be durable and economical with the added advantage of being boreable. Resleeved cylinders will never flake or peel.

CYLINDER REPAIR

Why would you spend several hundred dollars to buy a new cylinder when we can repair it for a fraction of the cost?

L.A. Sleeve offers re-sleeving services for automotive, small engine, motorcycle, ATV, snowmobile, marine and watercraft.

Four-stroke cylinders receive a newly installed cylinder sleeve, are bored, honed to fit the piston and the top is surfaced when required.

Two-stroke cylinders receive a newly installed sleeve. All of the ports are matched, blended and chamfered. The sleeved cylinder is bored and honed to fit the piston. The top deck is surfaced to be as new. A properly installed two-stroke sleeve renews the cylinder and retains the original performance of the engine.

Send us your cylinder or cylinder block along with instructions. Our sleeving department will install a new sleeve or multiple sleeves into your cylinder and return it ready to install and run.

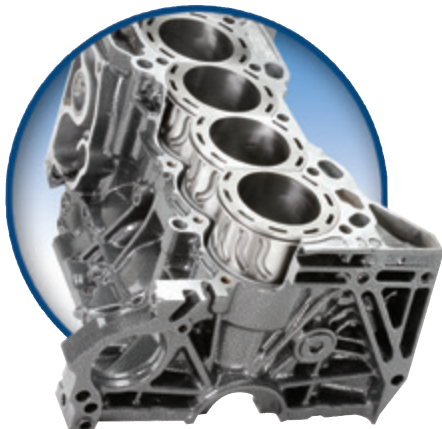

CYLINDER RE-PLATING

L.A. Sleeve offers a full cylinder re-plating service for the rider who desires to maintain the original plated bore. We will strip, weld and repair the damaged bore, then re-plate the cylinder bore with Nickel-Silicon-Carbide plating. L.A. Sleeve will supply you with a new piston and gasket kit and size the piston to the freshly plated bore.



CRANKSHAFT REBUILDING

We provide complete crank rebuilding to you. No need to buy an OEM crankshaft, when we can install a new aftermarket connecting rod kit. Our service comes complete with pressing crank apart, inspecting web journals, reinstalling new aftermarket rod kit and truing crank to exact tolerances.



4-STROKE HEAD SERVICE, REPAIR AND CNC PORTING

L.A. Sleeve is a leader in four-stroke development technology. Our years of experience will assure you receive the proper service required.

We will disassemble, inspect, rebuild and re-assemble your head. L.A. Sleeve uses state of the art CNC machinery to do head porting and valve work. We are able to perform a standard 3-angle valve job or a performance 5-angle radius valve job. We can replace worn valve guides or install high performance guides. Let us replace your iron valve seats with our copper/beryllium seats to insure reliability and longevity of your steel or titanium valves.



PRODUCT LINES

TOP END CYLINDER REBUILD KITS

Cylinder Rebuild Kits are available for 2-Stroke and 4-Stroke engines. Each rebuild kit is supplied with all of the quality engine parts to re-sleeve your cylinder and re-assemble the top end.

2-STROKE KITS feature a cylinder sleeve with the machined ports, a pro-cast or forged piston, rings, pin, clips and pin bearing. A top end gasket kit is included to assure a smooth re-assembly.

4-STROKE KITS include a cylinder sleeve, a pro-cast or forged piston, rings, pin, clips and a top end gasket kit. Many gasket kits include the valve stem seals.



L.A. SLEEVE CO. distributes a complete line of engine hard parts. Rebuilders can use our "One-Stop Shop" to purchase parts for top end and bottom end repair. We are the source for a vast array of OEM components.

Together with our cylinder sleeves and sleeve kits we proudly sell these fine products to handle your every engine rebuilding need.





OFFROAD





MODEL
Engine Description
Cylinder I.D. (mm/in.)

SLEEVE

REBUILD KIT
Sleeve - Piston
Gasket - T.E. Bearing

BORE SIZE (mm)

PISTON SIZE

TOP END

TOP END

BOTTOM END

PRO-X PISTON

WISECO PISTON

WOSSNER PISTON

VERTEX PISTON

T.E. BEARING

COMETIC GASKET

L.A. SLEEVE GASKET

CRANKSHAFT

CON-ROD KIT

CON-ROD ASSEMBLY
Rod - Bearings - Seals

CRANK BEARING

CRANK SEAL KIT

BOTTOM END KIT
Crankshaft - Bearings - Seals - Gasket Set

GASGAS TWO-STROKE

MC 50 49cc 39.5mm	2021-23 Liquid Cooled 1.555"	AC	FL-5746	39.50 39.51 41.50	Std. Std. .080	6019A 6019B	874M03950 877M04150	8262DA 8262DB	VT23429AB		T.E. Bearing B1041	Top End C3503	Top End 35-0337 Complete with Oil Seals 37-1337	HR4401	Pro-X 03.6011 Hot Rods HR8135				Hot Rods CBK0190
MC 65 64.8cc 45mm	2021-23 Liquid Cooled 1.772"	AC	FL-5747	45.00 45.01	Std. Std.	6029A 6029B	864M04500	8241DA 8241DB	VT23430AB VT23430CD		T.E. Bearing B1042	Top End C3416	Top End 35-0338 Complete with Oil Seals 37-1338	HR4031	Pro-X 03.6029 Hot Rods HR8132		6304JR2	096029	
MC 85 85cc 47mm	2021-23 Liquid Cooled 1.850"	AC	FL-5796	47.00 47.01	Std. Std.	6105A 6105B	855M04700	8147DA 8147DB	VT24212A VT24212B		T.E. Bearing 01154	Top End C3636			Pro-X 03.6113		Left NJ205 Right 6304/22	096103	
MC 125 125cc 54mm	2021-23 Liquid Cooled 2.126"	AC	FL-5804	54.00 54.01	Std. Std.	6226A 6226B (Double Ring)	868M05400 (Double Ring)	8220DA 8220DB (Single Ring)	VT23928A VT23928B (Double Ring)		T.E. Bearing 01153	Top End C3606	Top End 35-6009	HR00177	Pro-X 03.6226	39-6226	Left NJ206 Right 6205JR2	096218	
EC 250 249cc 66.4mm GASGAS Engine	1997-00 Liquid Cooled 2.614"	AC	FL-5483	66.40	Std.	7307A (97-19)		8052DA (97-19)			T.E. Bearing 01209				Pro-X 04980				
EX 250 249cc 66.4mm KTM Engine	2022-23 Liquid Cooled 2.614"	AC	FL-5811	66.40 66.41	Std. Std.	6343A 6343B	856M06640	8169DA 8169DB	VT23603A VT23603B		T.E. Bearing 01298	Top End C3623			Pro-X 04923	39-4923	Left NJ207R Right 6232X2	096320	
EX 250 249cc 66.4mm KTM Engine	2024 Liquid Cooled 2.614"	AC	FL-5859	66.40 66.41	Std. Std.	6343A 6343B	856M06640	8169DA 8169DB	VT23630A VT23630B		T.E. Bearing 01298	Top End C3811	Top End 35-6072	HR00125	Pro-X 04923	39-4923	Left NJ207R Right 6232X2	096320	
MC 250 249cc 66.4mm KTM Engine	2022-23 Liquid Cooled 2.614"	AC	FL-5811	66.40 66.41	Std. Std.	6343A 6343B	856M06640	8169DA 8169DB	VT23603A VT23603B		T.E. Bearing 01298	Top End C3623			Pro-X 04923	39-4923	Left NJ207R Right 6232X2	096320	
MC 250 249cc 66.4mm KTM Engine	2024 Liquid Cooled 2.614"	AC	FL-5859	66.40 66.41	Std. Std.	6343A 6343B	856M06640	8169DA 8169DB	VT23630A VT23630B		T.E. Bearing 01298	Top End C3811	Top End 35-6072	HR00125	Pro-X 04923	39-4923	Left NJ207R Right 6232X2	096320	
EX 300 297cc 72mm KTM Engine	2021-23 Liquid Cooled 2.834"	AC	FL-5815	72.00 72.01	Std. Std.	01.6388A 01.6388B	883M07200	8304DA 8304DB	VT24244A VT24244B		T.E. Bearing 01298	Top End C3623	Top End 35-0976 (21-22)		Pro-X 04923		Left NJ207R Right 6232X2	096320	
EX 300 297cc 72mm KTM Engine	2024 Liquid Cooled 2.834"	AC	FL-5860	72.00 72.01	Std. Std.	01.6388A 01.6388B	883M07200	8304DA 8304DB	VT24244A VT24244B		T.E. Bearing 01298		Top End 35-6072	HR00125	Pro-X 04923	39-4923	Left NJ207R Right 6232X2	096320	

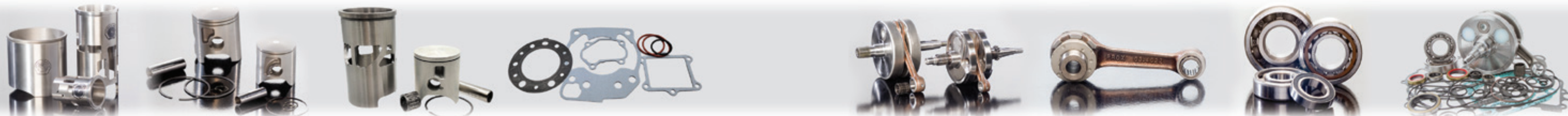

GASGAS
HONDA
HUSQVARNA
KAWASAKI
KTM
SUZUKI
YAMAHA
DIRT BIKE SLEEVES
STREET BIKE SLEEVES
ACCESSORIES
TECHNICAL



MODEL
Engine Description
Cylinder I.D. (mm/in.)



SLEEVE

REBUILD KIT
Sleeve • Piston
Gasket • T.E. Bearing

BORE SIZE (mm)

PISTON SIZE

TOP END

TOP END

VALVE TRAIN

BOTTOM END

PRO-X PISTON

WISECO PISTON

WOSSNER PISTON

VERTEX PISTON

JE PISTON

COMETIC GASKET

L.A. SLEEVE GASKET

CYLINDER AFTERMARKET KITS

VALVE / SPRING KIT

VALVE GUIDE

CAMSHAFT

CAM CHAIN

CRANKSHAFT

CON-ROD KIT

CRANK BEARING

ENGINE OIL SEAL KIT

BOTTOM END KIT
Crankshaft • Bearings • Seals • Gasket Set

GASGAS FOUR-STROKE

MODEL	Year	AC	FL	BORE	STROKE	PRO-X PISTON	WISECO PISTON	WOSSNER PISTON	VERTEX PISTON	JE PISTON	COMETIC GASKET	L.A. SLEEVE GASKET	CYLINDER AFTERMARKET KITS	VALVE / SPRING KIT	VALVE GUIDE	CAMSHAFT	CAM CHAIN	CRANKSHAFT	CON-ROD KIT	CRANK BEARING	ENGINE OIL SEAL KIT	BOTTOM END KIT	
EC 250 F 250cc 78mm	2021-23 Liquid-Cooled 3.071"	AC	FL-5743	78.00	Std. 78.01	13.9:1 Comp. 6333A 6333B	13.9:1 Comp. 40074M07800	13.9:1 Comp. 8865DA 8865DB	12.8:1 Comp. VT24196A VT24196B					Titanium Exhaust 28-63331 Titanium Intake 28-63332				CC-6356	Pro-X 03.6337				
MC 250 F EX 250 F 250cc 78mm	2021-23 2021-23 Liquid-Cooled 3.071"	AC	FL-5743	78.00	Std. 78.01	14.4:1 Comp. 6347A 6347B	14.4:1 Comp. 40144M07800	14.4:1 Comp. 8923DA 8923DB	14.4:1 Comp. VT24097A VT24097B	14.5:1 Comp. 366506	Top End C3595-EST	Top End 35-0372 Complete w/ oil seals 37-1372	Cylinder Works 50006 Complete Kit 50006-K01 (Std. 78mm)	Titanium Exhaust 28-63331 Titanium Intake 28-63332				CC-6356	Pro-X 03.6337 Wossner WR4067				
EC 350 F 350cc 88mm	2021-23 Liquid-Cooled 3.464"	AC	FL-5745	88.00	Std. 88.01	13.5:1 Comp. 6351A 6351B	14.1:1 Comp. 40264M08800	13.5:1 Comp. 8990DA 8990DB	14:1 Comp. VT24098A VT24098B				Cylinder Works 50008 (Std. 88mm)	Steel Exhaust 28-63621 Steel Intake 28-63622				CC-6356					
MC 350 F EX 350 F 350cc 88mm	2022-23 2021-23 Liquid-Cooled 3.464"	AC	FL-5745	88.00	Std. 88.01	13.5:1 Comp. 6351A 6351B	14.1:1 Comp. 40264M08800	13.5:1 Comp. 8990DA 8990DB	14:1 Comp. VT24098A VT24098B	14.5:1 Comp. 366506	Top End C3790	Top End 35-0035	Cylinder Works 50008 (Std. 88mm)	Titanium Exhaust 28-63511 Titanium Intake 28-63512				CC-6356	Pro-X 03.6366				
MC 450 F EX 450 F 449cc 95mm	2021-23 2021-23 Liquid-Cooled 3.740"	AC	FL-5744	95.00	Std. 95.01	12.6:1 Comp. 6433A 6433B	12.75:1 Comp. 40297M09500	12.6:1 Comp. 8868DA 8868DB	12.6:1 Comp. VT24099A VT24099B		Top End C3604-EST	Top End 35-0374	Cylinder Works 50009 (Std. 95mm)	Titanium Exhaust 28-64191 Titanium Intake 28-64192				CC-1335	Pro-X 03.6436				

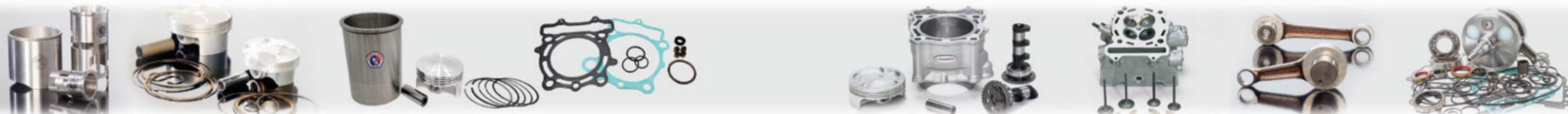

GASGAS
HONDA
HUSQVARNA
KAWASAKI
KTM
SUZUKI
YAMAHA
DIRT BIKE SLEEVES
STREET BIKE SLEEVES
ACCESSORIES
TECHNICAL



MODEL
Engine Description
Cylinder I.D. (mm/in.)



SLEEVE

REBUILD KIT
Sleeve - Piston
Gasket - T.E. Bearing

BORE SIZE (mm)

PISTON SIZE

TOP END

TOP END

BOTTOM END

PRO-X PISTON

WISECO PISTON

WOSSNER PISTON

VERTEX PISTON

T.E. BEARING

COMETIC GASKET

L.A. SLEEVE GASKET

CRANKSHAFT

CON-ROD KIT

CON-ROD ASSEMBLY
Rod - Bearings - Seals

CRANK BEARING

CRANK SEAL KIT

BOTTOM END KIT
Crankshaft - Bearings - Seals - Gasket Set

HONDA TWO-STROKE

CR-80R 83cc 47mm 2-Stroke Liquid Cooled 1.850"	1986	AC	H-948	948K	47.00 47.01 47.50 48.00 49.00	Std. Std. .020 .040 .080	4080B 4080C 4082B	643M04700 643M04750 643M04800 643M04900					T.E. Bearing 01154	Top End C7003	Top End 35-1205 (86-91) Complete with Oil Seals 37-1205	HR4012	Pro-X 04972	39-4972	6322X Bearing / Seal Kit 494181	094181	Hot Rods CBK0045
CR-80R 83cc 47mm 2-Stroke Liquid Cooled 1.850"	1987-02	AC	H-5066	5066K (87-91) 5066K-2 (92-02)	47.00 47.01 47.50 48.00 49.00	Std. Std. .020 .040 .080	4080B 4080C 4082B	643M04700 643M04750 643M04800 643M04900					T.E. Bearing 01154	Top End C7003 (86-91) C7126 (92-02) C7305 (92-02) (49mm)	Top End 35-1205 (86-91) 35-1112 (92-02) Complete with Oil Seals 37-1205 (87-01) 37-1206 (92-02)	HR4012	Pro-X 04972	39-4972	6322X Bearing / Seal Kit 494181	094181	Hot Rods CBK0045 (86-91) CBK0001 (92-02)
CR-80R Big Bore to 105cc 52mm 2.047"	1986-02	AC	H-948B		52.40 52.45 52.60	Std. Std. .010	W948P5240 W948P5245 W948P5260						T.E. Bearing 01154	GS948		HR4012	Pro-X 04972	39-4972	6322X Bearing / Seal Kit 494181	094181	
CR-85R 84.7cc 47.5mm 2-Stroke Liquid Cooled 1.870"	2003-04	AC	H-5488	5488K	47.50 47.51 48.00 48.50 49.50	Std. Std. .020 .040 .080	4082B 4082C	833M04750 833M04800 833M04850 833M04950 833M05050	8105DA 8105DB				T.E. Bearing 01154	Top End C7126 C7305 (49mm) C7315 (52mm)	Top End 35-1113 Complete with Oil Seals 37-1113	HR4012	Pro-X 04972	39-4972	6322X Bearing / Seal Kit 494181	094181	Hot Rods CBK0047
CR-85R Big Bore to 96cc 50.5mm 1.988"	2003-04	BB	H-5488B		50.50	.120		833M05050					T.E. Bearing 01154	Top End C7315		HR4012	Pro-X 04972	39-4972	6322X Bearing / Seal Kit 494181	094181	
CR-85R 84.7cc 47.5mm 2-Stroke (GBFV) Liquid Cooled 1.870"	2005-07	AC	H-5599	5599K	47.50 47.51 48.00 48.50 49.50	Std. Std. .020 .040 .080	4082B 4082C	833M04750 833M04800 833M04850 833M04950 833M05050	8105DA 8105DB				T.E. Bearing 01154	Top End C7126 (48.5mm) C7315 (52mm)	Top End 35-1114 Complete with Oil Seals 37-1114	HR4068	Pro-X 04972	39-4972	6322X Bearing / Seal Kit 494181	094181	Hot Rods CBK0104
CR-85R Big Bore to 96cc 50.5mm 1.988"	2005-07	BB	H-5599B		50.50	.120		833M05050						Top End C7315 (52mm)		HR4068	Pro-X 04972	39-4972	6322X Bearing / Seal Kit 494181	094181	

GASGAS
HONDA
HUSQVARNA
KAWASAKI
KTM
SUZUKI
YAMAHA
DIRT BIKE SLEEVES
STREET BIKE SLEEVES
ACCESSORIES
TECHNICAL

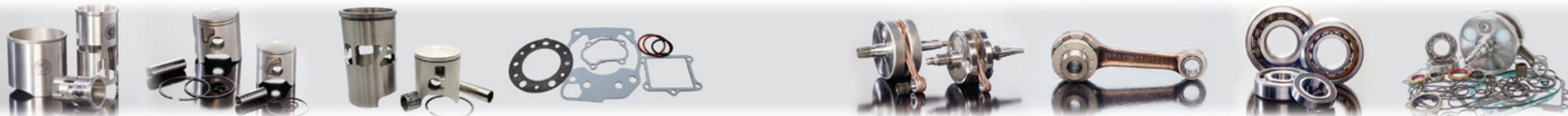



MODEL
Engine Description
Cylinder I.D. (mm/in.)



SLEEVE

REBUILD KIT
Sleeve - Piston
Gasket - T.E. Bearing

BORE SIZE (mm)

PISTON SIZE

TOP END

TOP END

BOTTOM END

PRO-X PISTON

WISECO PISTON

WOSSNER PISTON

VERTEX PISTON

T.E. BEARING

COMETIC GASKET

L.A. SLEEVE GASKET

CRANKSHAFT

CON-ROD KIT

CON-ROD ASSEMBLY
Rod - Bearings - Seals

CRANK BEARING

CRANK SEAL KIT

BOTTOM END KIT
Crankshaft - Bearings - Seals - Gasket Set

HONDA TWO-STROKE (CONTINUED)

MODEL	Engine Description	Cylinder I.D. (mm/in.)	SLEEVE	REBUILD KIT	BORE SIZE (mm)	PISTON SIZE	PRO-X PISTON	WISECO PISTON	WOSSNER PISTON	VERTEX PISTON	T.E. BEARING	COMETIC GASKET	L.A. SLEEVE GASKET	CRANKSHAFT	CON-ROD KIT	CON-ROD ASSEMBLY	CRANK BEARING	CRANK SEAL KIT	BOTTOM END KIT
CR-125R 1989 125cc 2-Stroke Liquid Cooled 54mm 2.126"	AC	H-5075	5075K	54.00 54.01 54.50 55.00 55.50 56.00	Std. Std. .020 .040 .060 .080	4240A 4240D	564M05400 564M05450 564M05500 564M05550 564M05600	8125DA 8125D050 8125D100 8125D150 8125D200			T.E. Bearing 01152	Top End C7009	Top End 35-1233 Complete with Oil Seals 37-1233		Pro-X 04959 Hot Rods HR8101	39-4959	6322X Bearing / Seal Kit 494184	094184	
CR-125R 1990-91 125cc 2-Stroke Liquid Cooled 54mm 2.126"	AC	H-5104	5104K	54.00 54.01 54.50 55.00	Std. Std. .020 .040	4240A 4240D	595M05400 595M05450 595M05500	8107DA 8107DB 8107D050 8107D100			T.E. Bearing 01152	Top End C7010	Top End 35-1212 Complete with Oil Seals 37-1212	HR4053	Pro-X 04959 Hot Rods HR8101	39-4959	6322X Bearing / Seal Kit 494184	094184	Hot Rods CBK0089
CR-125R 1992 124cc 2-Stroke Liquid Cooled 54mm 2.126"	AC	H-5301	5301K	54.00 54.01 54.50 55.00 56.00	Std. Std. .020 .040 .080	4260A 4260B	676M05400 676M05450 676M05500 676M05600	8020DA 8020DB 8020D050 8020D100 8020D200	VT22189B		T.E. Bearing 01152	Top End C7115 (55mm) C7306 (56mm)	Top End 35-1212 Complete with Oil Seals 37-1212	HR4053	Pro-X 04959 Hot Rods HR8101	39-4959	6322X Bearing / Seal Kit 494184	094184	Hot Rods CBK0089
CR-125R 1993-95 124cc 2-Stroke Liquid Cooled 54mm 2.126"	AC	H-5249	5249K	54.00 54.01 54.50 55.00 56.00	Std. Std. .020 .040 .080	4260A 4260B	676M05400 676M05450 676M05500 676M05600	8020DA 8020DB 8020D050 8020D100 8020D200	VT22189B		T.E. Bearing 01152	Top End C7115 (55mm) C7306 (56mm)	Top End 35-1212 Complete with Oil Seals 37-1212	HR4053	Pro-X 04959 Hot Rods HR8101	39-4959	6322X Bearing / Seal Kit 494184	094184	Hot Rods CBK0089
CR-125R 1996-99 125cc 2-Stroke Liquid Cooled 54mm 2.126"	AC	H-5291	5291K (96-97) 5291K-1 (98-99)	54.00 54.01 54.50 55.00 56.00	Std. Std. .020 .040 .080	4260A 4260B	676M05400 676M05450 676M05500 676M05600	8020DA 8020DB 8020D050 8020D100 8020D200	VT22189B		T.E. Bearing 01152	Top End C7115 (96-97) (55mm) C7306 (96-97) (56mm) C7394 (98-99) (55mm) C7406 (98-99) (56mm)	Top End 35-1212 (96-97) 35-1218 (98-99) Complete with Oil Seals 37-1212 (96-97) 37-1218 (98-99)	HR4053	Pro-X 04959 Hot Rods HR8101	39-4959	6322X Bearing / Seal Kit 494184	094184	Hot Rods CBK0089 (96-97) CBK0018 (98-99)
CR-125R 2000 125cc 2-Stroke Liquid Cooled 54mm 2.126"	AC	H-5439	5439K	54.00 54.01 54.50 55.00 56.00	Std. Std. .020 .040 .080	4260A 4260B	676M05400 676M05450 676M05500 676M05600	8067DA 8067DB 8067D050 8067D100 8067D200	VT22685C		T.E. Bearing 01152	Top End C7678 (54mm) C7694 (56mm)	Top End 35-1219 Complete with Oil Seals 37-1219	HR4053	Pro-X 04959 Hot Rods HR8101	39-4959	6322X Bearing / Seal Kit 494184	094184	Hot Rods CBK0023
CR-125R 2001 125cc 2-Stroke Liquid Cooled 54mm 2.126"	AC	H-5450	5450K	54.00 54.01 54.50 55.00 56.00	Std. Std. .020 .040 .080	4260A 4260B	676M05400 676M05450 676M05500 676M05600	8067DA 8067DB 8067D050 8067D100 8067D200	VT22685C		T.E. Bearing 01152	Top End C7757	Top End 35-1219 Complete with Oil Seals 37-1237	HR4053	Pro-X 04959 Hot Rods HR8101	39-4959	6322X Bearing / Seal Kit 494184	094184	Hot Rods CBK0019



GASGAS
HONDA
HUSQVARNA
KAWASAKI
KTM
SUZUKI
YAMAHA
DIRT BIKE SLEEVES
STREET BIKE SLEEVES
ACCESSORIES
TECHNICAL



MODEL
Engine Description
Cylinder I.D. (mm/in.)



SLEEVE

REBUILD KIT
Sleeve - Piston
Gasket - T.E. Bearing

BORE SIZE (mm)

PISTON SIZE

TOP END

TOP END

BOTTOM END

PRO-X PISTON

WISECO PISTON

WOSSNER PISTON

VERTEX PISTON

T.E. BEARING

COMETIC GASKET

L.A. SLEEVE GASKET

CRANKSHAFT

CON-ROD KIT

CON-ROD ASSEMBLY
Rod - Bearings - Seals

CRANK BEARING

CRANK SEAL KIT

BOTTOM END KIT
Crankshaft - Bearings - Seals - Gasket Set

HONDA TWO-STROKE (CONTINUED)

MODEL	Engine Description	Cylinder I.D. (mm/in.)	SLEEVE	REBUILD KIT	BORE SIZE (mm)	PISTON SIZE	PRO-X PISTON	WISECO PISTON	WOSSNER PISTON	VERTEX PISTON	T.E. BEARING	COMETIC GASKET	L.A. SLEEVE GASKET	CRANKSHAFT	CON-ROD KIT	CON-ROD ASSEMBLY	CRANK BEARING	CRANK SEAL KIT	BOTTOM END KIT	
CR-125R 2002 125cc 2-Stroke (01) Liquid Cooled 54mm 2.126"	AC	H-5466	5466K	54.00 54.01 54.50 55.00 56.00	Std. Std. .020 .040 .080	4260A 4260B	676M05400 676M05450 676M05500 676M05600	8067DA 8067DB 8067D050 8067D100 8067D200		VT22685C	T.E. Bearing 01152	Top End C7757	Top End 35-1219 Complete with Oil Seals 37-1237	HR4053	Pro-X 04959 Hot Rods HR8101	39-4959	6322X Bearing / Seal Kit 494184	094184	Hot Rods CBK0019	
CR-125R 2003 125cc 2-Stroke (02) Liquid Cooled 54mm 2.126"	AC	H-5489	5489K	54.00 54.01 54.50 55.00 56.00	Std. Std. .020 .040 .080	4260A 4260B	676M05400 676M05450 676M05500 676M05600	8067DA 8067DB 8067D050 8067D100 8067D200		VT22685C	T.E. Bearing 01152	Top End C7181 (54mm) Top End C7184 (56mm)	Top End 35-1221 Complete with Oil Seals 37-1221	HR4053	Pro-X 04959 Hot Rods HR8101	39-4959	6322X Bearing / Seal Kit 494184	094184	Hot Rods CBK0020	
CR-125R 2004 125cc 2-Stroke Liquid Cooled 54mm 2.126" KSR(A) CYLINDER SLEEVING REQUIRED FOR OVERSIZES	AC	H-5568	5568K	54.00 54.01 54.50 55.00 56.00	Std. Std. .020 .040 .080	4360A 4360B 4362 4364	840M05400	8100DA 8100DB 8100D200			T.E. Bearing 01152	Top End C7181 (54mm) Top End C7184 (56mm)	Top End 35-1221 Complete with Oil Seals 37-1243	HR4053	Pro-X 04959 Hot Rods HR8101	39-4959	6322X Bearing / Seal Kit 494184	094184	Hot Rods CBK0021	
CR-125R 2005-07 125cc 2-Stroke Liquid Cooled 54mm 2.126" KSR(F) CYLINDER SLEEVING REQUIRED FOR OVERSIZES	AC	H-5579	5579K	54.00 54.01 56.00	Std. Std. .080	4370A 4370B	859M05400	8170DA 8170DB 8170D200			T.E. Bearing 01152	Top End C3085 (54mm) C3088 (56mm)	Top End 35-1224 Complete with Oil Seals 37-1224	HR4053	Pro-X 04959 Hot Rods HR8101	39-4959	6322X Bearing / Seal Kit 494184	094184	Hot Rods CBK0022	
CR-250R 1978-80 247cc 2-Stroke 70mm 2.756" CYLINDER SLEEVING REQUIRED FOR OVERSIZES	AC	H-88		70.00 70.50 71.00 71.50 72.00	Std. .020 .040 .060 .080		431M07000 431M07050 431M07100 431M07150 431M07200	8154DA 8154D050 8154D100 8154D150 8154D200			T.E. Bearing 01181	C7278					6328C3			
CR-250R 1981-83 246cc 2-Stroke 66mm 2.598" SPECIAL HEAVY O.D. SLEEVE TO REPAIR BROKEN CYLINDER SKIRTS	CI CS/MO	H-104 H-104H		66.00 67.00 68.00	Std. .040 .080		466M06600 466M06700 466M06800				T.E. Bearing 01181	Top End C7011 (81-82) C7108 (83)						6328C3 Bearing / Seal Kit 494185	094185	
CR-250R ATAC 1984 246cc 2-Stroke Liquid Cooled (Non Bridged Exhaust) 66mm 2.598" SPECIAL HEAVY O.D. SLEEVE TO REPAIR BROKEN CYLINDER SKIRTS	CI CS/MO	H-843 H-843H		66.00 66.25 66.50 66.75 67.00 67.25 67.50 68.00	Std. .010 .020 .030 .040 .050 .060 .080		526M06600 526M06625 526M06650 526M06675 526M06700 526M06725 526M06750 526M06800	8156DA 8156D050 8156D100 8156D150 8156D200			T.E. Bearing 01181	Top End C7012 (68mm) C7270 (68.5mm)		Pro-X 04980 Hot Rods HR8103	39-4186	6328C3 Bearing / Seal Kit 494186	094186			
CR-250R ATAC 1985 246cc 2-Stroke Liquid Cooled 66mm 2.598" SPECIAL HEAVY O.D. SLEEVE TO REPAIR BROKEN CYLINDER SKIRTS	CI CS/MO	H-844 H-844H		66.00 66.25 66.50 66.75 67.00 67.25 67.50 68.00	Std. .010 .020 .030 .040 .050 .060 .080		526M06600 526M06625 526M06650 526M06675 526M06700 526M06725 526M06750 526M06800	8156DA 8156D050 8156D100 8156D150 8156D200			T.E. Bearing 01181	Top End C7013 (68mm)		Pro-X 04980 Hot Rods HR8103	39-4186	6328C3 Bearing / Seal Kit 494186	094186			



GASGAS
HONDA
HUSQVARNA
KAWASAKI
KTM
SUZUKI
YAMAHA
DIRT BIKE SLEEVES
STREET BIKE SLEEVES
ACCESSORIES
TECHNICAL



MODEL
Engine Description
Cylinder I.D. (mm/in.)



SLEEVE

REBUILD KIT
Sleeve - Piston
Gasket - T.E. Bearing

BORE SIZE (mm)

PISTON SIZE

TOP END

TOP END

BOTTOM END

PRO-X PISTON

WISECO PISTON

WOSSNER PISTON

VERTEX PISTON

T.E. BEARING

COMETIC GASKET

L.A. SLEEVE GASKET

CRANKSHAFT

CON-ROD KIT

CON-ROD ASSEMBLY
Rod - Bearings - Seals

CRANK BEARING

CRANK SEAL KIT

BOTTOM END KIT
Crankshaft - Bearings - Seals - Gasket Set

HONDA TWO-STROKE (CONTINUED)

MODEL	Engine Description	Cylinder I.D. (mm/in.)	AC	H	Year	958K	66.40	Std.	4420A	614M06640	8021DA			T.E. Bearing	Top End	Complete with Oil Seals	37-1254	Pro-X	39-4186	6328C3	094186		
CR-250R 249cc	1986 2-Stroke Liquid Cooled	66.4mm 2.614"	AC	H-958	958K	66.40 66.41 67.00 67.50 68.00 68.50	Std. Std. .023 .043 .065 .085	4420A 4420B	614M06640 614M06700 614M06750 614M06800 614M06850	8021DA 8021DB 8021D060 8021D110 8021D160 8021D210			T.E. Bearing 01181	Top End C7015	Complete with Oil Seals 37-1254		Pro-X 04980 Hot Rods HR8103		39-4186	6328C3	094186	Bearing / Seal Kit 494186	
CR-250R 249cc	1987 2-Stroke Liquid Cooled	66.4mm 2.614"	AC	H-5002	5002K	66.40 66.41 67.00 67.50 68.00 68.50	Std. Std. .023 .043 .065 .085	4420A 4420B	614M06640 614M06700 614M06750 614M06800 614M06850	8021DA 8021DB 8021D060 8021D110 8021D160 8021D210			T.E. Bearing 01181	Top End C7015	Complete with Oil Seals 37-1255		Pro-X 04980 Hot Rods HR8103		39-4186	6328C3	094186	Bearing / Seal Kit 494186	
CR-250R 249cc	1988-89 2-Stroke Liquid Cooled	66.4mm 2.614"	AC	H-5076	5076K	66.40 66.41 67.00 67.50 68.00 68.50	Std. Std. .023 .043 .065 .085	4420A 4420B	614M06640 614M06700 614M06750 614M06800 614M06850	8021DA 8021DB 8021D060 8021D110 8021D160 8021D210			T.E. Bearing 01181	Top End C7015	Complete with Oil Seals 37-1256 (88) 37-1257 (89)		Pro-X 04980 Hot Rods HR8103		39-4186	6328C3	094186	Bearing / Seal Kit 494186	
CR-250R 249cc	1990-91 2-Stroke Liquid Cooled	66.4mm 2.614"	AC	H-5105	5105K	66.40 66.41 67.00 67.50 68.00 68.50	Std. Std. .023 .043 .065 .085	4420A 4420B	614M06640 614M06700 614M06750 614M06800 614M06850	8021DA 8021DB 8021D060 8021D110 8021D160 8021D210			T.E. Bearing 01181	Top End C7016	Complete with Oil Seals 37-1257		Pro-X 04980 Hot Rods HR8103		39-4186	6328C3	094186	Bearing / Seal Kit 494186	
CR-250R 249cc	1992-93 2-Stroke Liquid Cooled	66.4mm 2.614"	AC	H-5178	5178K	66.40 66.41 67.00 67.50 68.00 68.50	Std. Std. .023 .043 .065 .085	4420A 4420B	614M06640 614M06700 614M06750 614M06800 614M06850	8021DA 8021DB 8021D060 8021D110 8021D160 8021D210			T.E. Bearing 01181	Top End C7116	Top End 35-1312 Complete with Oil Seals 37-1312	HR4002	Pro-X 04980 Hot Rods HR8103		39-4980	6328C3	094187	Bearing / Seal Kit 494187	Hot Rods CBK0040
CR-250R 249cc	1994 2-Stroke Liquid Cooled	66.4mm 2.614"	AC	H-5198	5198K	66.40 66.41 67.00 67.50 68.00 68.50	Std. Std. .023 .043 .065 .085	4420A 4420B	614M06640 614M06700 614M06750 614M06800 614M06850	8021DA 8021DB 8021D060 8021D110 8021D160 8021D210			T.E. Bearing 01181	Top End C7116	Top End 35-1312 Complete with Oil Seals 37-1312	HR4002	Pro-X 04980 Hot Rods HR8103		39-4980	6328C3	094187	Bearing / Seal Kit 494187	Hot Rods CBK0040
CR-250R 249cc	1995-96 2-Stroke Liquid Cooled	66.4mm 2.614"	AC	H-5250	5250K	66.40 66.41 67.00 67.50 68.00 68.50	Std. Std. .023 .043 .065 .085	4420A 4420B	614M06640 614M06700 614M06750 614M06800 614M06850	8021DA 8021DB 8021D060 8021D110 8021D160 8021D210			T.E. Bearing 01181	Top End C7116	Top End 35-1312 Complete with Oil Seals 37-1312	HR4002	Pro-X 04980 Hot Rods HR8103		39-4980	6328C3	094187	Bearing / Seal Kit 494187	Hot Rods CBK0040
CR-250R 249cc	1997-98 2-Stroke Liquid Cooled	66.4mm 2.614"	AC	H-5318	5318K	66.40 66.41 67.00 67.50 68.00 *68.50 *68.75 *69.00	Std. Std. .023 .043 .065 .085 .095 .105	4430A 4430B 4436 4437 4438 4439	702M06640 702M06700 702M06750 702M06800 702M06850	8001DA 8001DB 8001D060 8001D110			T.E. Bearing 01181	Top End C7116 (66.4-68mm) C7303 (69-72mm)	Top End 35-1312 Complete with Oil Seals 37-1312	HR4002	Pro-X 04980 Hot Rods HR8103		39-4980	6328C3	094187	Bearing / Seal Kit 494187	Hot Rods CBK0040
						*Power Valve and Head Mod Required																	



GASGAS
HONDA
HUSQVARNA
KAWASAKI
KTM
SUZUKI
YAMAHA
DIRT BIKE SLEEVES
STREET BIKE SLEEVES
ACCESSORIES
TECHNICAL



MODEL
Engine Description
Cylinder I.D. (mm/in.)



SLEEVE

REBUILD KIT
Sleeve - Piston
Gasket - T.E. Bearing

BORE SIZE (mm)

PISTON SIZE

TOP END

TOP END

BOTTOM END

PRO-X PISTON

WISECO PISTON

WOSSNER PISTON

VERTEX PISTON

T.E. BEARING

COMETIC GASKET

L.A. SLEEVE GASKET

CRANKSHAFT

CON-ROD KIT

CON-ROD ASSEMBLY
Rod - Bearings - Seals

CRANK BEARING

CRANK SEAL KIT

BOTTOM END KIT
Crankshaft - Bearings - Seals - Gasket Set

HONDA TWO-STROKE (CONTINUED)

CR-250R (KZ3S, KZ3T) 1999-00 249cc 2-Stroke Liquid Cooled 66.4mm 2.614" CYLINDER SLEEVING REQUIRED FOR OVERSIZES	AC	H-5375	5375K	66.40	Std.	4430A	702M06640	8001DA					T.E. Bearing 01181	Top End C7116 (66.4-68mm) C7303 (69-72mm)	Top End 35-1312 Complete with Oil Seals 37-1312 UP TO 68MM ONLY	HR4002	Pro-X 04980	39-4980	6328C3	094187	Hot Rods CBK0040
				66.41	Std.	4430B		8001DB											Bearing / Seal Kit 494187		
CR-250R (KZ3V) 2001 249cc 2-Stroke Liquid Cooled 66.4mm 2.614" CYLINDER SLEEVING REQUIRED FOR OVERSIZES	AC	H-5448	5448K	66.40	Std.	4430A	702M06640	8001DA					T.E. Bearing 01181	Top End C7116 (66.4-68mm) C7303 (69-72mm)	Top End 35-1312 Complete with Oil Seals 37-1312 UP TO 68MM ONLY	HR4002	Pro-X 04980	39-4980	6328C3	094187	Hot Rods CBK0040
				66.41	Std.	4430B		8001DB											Bearing / Seal Kit 494187		
CR-250R (KZ3W, KZ3X) 2002-03 249cc 2-Stroke Liquid Cooled 66.4mm 2.614" CYLINDER SLEEVING REQUIRED FOR OVERSIZES	AC	H-5477	5477K	66.40	Std.	1322A	801M06640	8066DA					T.E. Bearing 01181	Top End C7191 (66.5mm) C7197 (68.5mm)	Top End 35-1322 Complete with Oil Seals 37-1322	HR4056	Pro-X 04931	39-4931	6328C3	094187	Hot Rods CBK0092
				66.41	Std.	1322B		8066DB											Bearing / Seal Kit 494187		
CR-250R (KSK) 2004 249cc 2-Stroke Liquid Cooled 66.4mm 2.614" CYLINDER SLEEVING REQUIRED FOR OVERSIZES	AC	H-5535	5535K	66.40	Std.	1322A	801M06640	8066DA					T.E. Bearing 01181	Top End C7191 (66.5mm) C7197 (68.5mm)	Top End 35-1322 Complete with Oil Seals 37-1322	HR4056	Pro-X 04931	39-4931	6328C3	094187	Hot Rods CBK0092
				66.41	Std.	1322B		8066DB											Bearing / Seal Kit 494187		
CR-250R (KSK) 2005-07 249cc 2-Stroke Liquid Cooled 66.4mm 2.614" CYLINDER SLEEVING REQUIRED FOR OVERSIZES	AC	H-5580	5580K	66.40	Std.	1325A	860M6640	8171DA					T.E. Bearing 01181	Top End C3089 (66.5mm) C3092 (68.5mm)	Top End 35-1323 Complete with Oil Seals 37-1323	HR4056	Pro-X 04931	39-4931	6328C3	094187	Hot Rods CBK0024
				66.41	Std.	1325B		8171DB											Bearing / Seal Kit 494187		
<i>*Power Valve and Head Mod Required</i>																					



GASGAS
HONDA
HUSQVARNA
KAWASAKI
KTM
SUZUKI
YAMAHA
DIRT BIKE SLEEVES
STREET BIKE SLEEVES
ACCESSORIES
TECHNICAL



MODEL
Engine Description
Cylinder I.D. (mm/in.)

SLEEVE

REBUILD KIT
Sleeve • Piston
Gasket • T.E. Bearing

BORE SIZE (mm)

PISTON SIZE

TOP END

TOP END

VALVE TRAIN

BOTTOM END

PRO-X PISTON

WISECO PISTON

WOSSNER PISTON

VERTEX PISTON

JE PISTON

COMETIC GASKET

L.A. SLEEVE GASKET

CYLINDER AFTERMARKET KITS

VALVE / SPRING KIT

VALVE GUIDE

CAMSHAFT

CAM CHAIN

CRANKSHAFT

CON-ROD KIT

CRANK BEARING

ENGINE OIL SEAL KIT

BOTTOM END KIT
Crankshaft • Bearings • Seals • Gasket Set

HONDA FOUR-STROKE

CRF-50F 2004-09, 11-24 XR-50R 2000-03 49cc Single 39mm 1.535"	CC	H-5438	5438K	39.00 39.50 40.00 40.50 41.00	Std. .020 .040 .060 .080	4060 4062 4064 4066	4798M03900 4798M03950 4798M04000 4798M04050 4798M04100				Top End C7974-EST (39mm) C7975-EST (41mm)	Top End 35-0209 Complete w/ oil seals 37-1209	Steel Intake 30-30530 Steel Exhaust 30-30533	Valve Guide Intake 30-30530 Exhaust 30-30520		CC-011		Pro-X 31090							
CRF-70F 2004-09, 11-12 XR-70R 1997-03 72cc Single 47mm 1.850"	CC	H-5387	5387K	47.00 47.50 48.00 48.50 49.00	Std. .020 .040 .060 .080	4070 4072 4074 4076 4078	4880M04700 4880M04750 4880M04800				Top End C7300-EST	Top End 35-0210 Complete w/oil seals 37-1210	Steel Intake 28-10232 Steel Exhaust 28-10231												
CRF-80F 2004-09, 11-13 XR-80R 1979-03 XL-80 1982-85 72cc Single 47mm 1.850"	CS	H-101		48.00 48.50 49.00 49.50	.020 .040 .060 .080		4665M04800 4665M04850 4665M04900 4665M04950 (Not for XL)				Top End C7230 (79-91) C7231-EST (93-13)	Complete w/oil seals 37-1207 (79-91) 37-1208 (93-09)	Steel Intake 28-10502 Steel Exhaust 28-10501	Valve Guide Intake 30-30250 Exhaust 30-30260	Hot Cams Camshaft 1018-1										
CRF-100F 2004-09, 11-13 XR-100R 1992-03 99cc Single 53mm 2.087"	CI	H-5197	5197K	53.00 53.50 54.00 54.50 55.00	Std. .020 .040 .060 .080	65.1450A 65.1450.050 65.1450.100 (LAPC Piston)	4666M05350 4666M05400 4666M05450 4666M05500				Top End C7989-EST	Top End 35-0221 Complete w/oil seals 37-0221	Steel Intake 28-10502 Steel Exhaust 28-10501 Spring Kit 30-30235	Valve Guide Intake 30-30250 O/S +.001 30-30251 Exhaust 30-30260 O/S +.001 30-30261	Hot Cams Camshaft 1018-1	CC-012				6322X					
CRF-100F 2004-13 XR-100R 1992-03 Big Bore to 120cc 56mm to 58mm 2.204"	BB	H-5197B		58.00	.196		4773M05800				Top End C7986					Hot Cams Camshaft 1018-1	CC-012					6322X			
CRF-150F 2003-05 157cc Single 63.5mm 2.500"	CI	H-5490									Top End C3131-EST	Top End 35-0238													
CRF-150F 2006-17 149cc Single 57.3mm 2.256"	CI	H-5606		57.50 58.00 58.50	.007 .027 .047						Top End C3499-EST	Top End 35-0248													
CRF-150R 2007-24 149cc Single Liquid Cooled 66mm 2.598" <i>CYLINDER SLEEVING REQUIRED FOR OVERSIZES</i> <i>CYLINDER WORKS COMPLETE KIT INCLUDES CYLINDER, PISTON, TOP END GASKETS</i>	AC	H-5635	5635K (07-09) 5635K-1 (12-24)	66.00 66.01 68.00 66.00 66.01 68.00 66.00 66.01	Std. Std. .080 Std. Std. .080 Std. Std.	11.7:1 Comp. 1227A 1227B (07-09) 11.7:1 Comp. 01.1232A 01.1232B (2012-24)	11.7:1 Comp. 4915M06600 (07-09) 11.7:1 Comp. 40065M06600 (2012-24)	12.5:1 Comp. 8662DA 8662DB (07-09) 12.2:1 Comp. 8861DA 8861DB (2012-24)	11.7:1 Comp. VT23302A VT23302B (07-09) 11.7:1 Comp. VT23759A VT23759B VT23868A (2012-24)	12:1 Comp. 262278 13.1 Comp. 262281 (07-09) 12.2:1 Comp. VT23304A VT23304B (07-24) 13.5:1 Comp. 366509 (2012-24)	Top End C3187-EST (66mm) C3171-EST (68mm)	Top End 35-0213 Complete w/oil seals 37-1213	Cylinder Works 10004 (Std. 66mm) Cylinder Works Complete Kit 10004-K01 (07-09) (Std. 66mm) 10004-K02 (12-24) (Std. 66mm)	Steel Intake 28-12272 Steel Exhaust 28-12271 Kibblewhite Valve Spring Kit 30-30880	Valve Guide Intake 30-30890 Exhaust 30-30900	Hot Cams Camshaft 1079-1 (Stage 1) 1080-2 (Stage 2) (Top End)	CC-013	Hot Rods HR4075 Stroker +2mm 156cc HR4175	Pro-X 03.1227 Hot Rods HR8646 Wossner WR4024	Left 8ENK60 Right SX04B10 Bearing / Seal Kit 49K052	49-822332	Hot Rods (07-21) CBK0111			
CRF-150R 2007-23 Big Bore to 170cc 70mm 2.756"	BB	H-5635B H-5733 (Wet Liner)		70.00							Top End GS5635		L.A. SLEEVE Sleeved Cyl. 11004SL (70mm, 170cc)	Steel Intake 28-12272 Steel Exhaust 28-12271 Kibblewhite Valve Spring Kit 30-30880		Hot Cams Camshaft 1079-1 (Stage 1) 1080-2 (Stage 2)									
XR-150L 2023-24 149cc Single 57.3mm 2.256"		H-5606																							

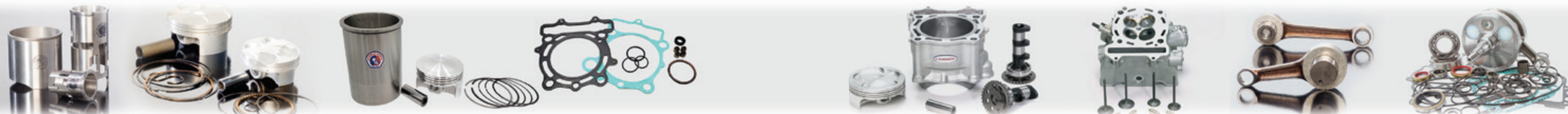

GASGAS
HONDA
HUSQVARNA
KAWASAKI
KTM
SUZUKI
YAMAHA
DIRT BIKE SLEEVES
STREET BIKE SLEEVES
ACCESSORIES
TECHNICAL



MODEL
Engine Description
Cylinder I.D. (mm/in.)



SLEEVE

REBUILD KIT
Sleeve • Piston
Gasket • T.E. Bearing

BORE SIZE (mm)

PISTON SIZE

TOP END

TOP END

VALVE TRAIN

BOTTOM END

PRO-X PISTON

WISECO PISTON

WOSSNER PISTON

VERTEX PISTON

JE PISTON

COMETIC GASKET

L.A. SLEEVE GASKET

CYLINDER AFTERMARKET KITS

VALVE / SPRING KIT

VALVE GUIDE

CAMSHAFT

CAM CHAIN

CRANKSHAFT

CON-ROD KIT

CRANK BEARING

ENGINE OIL SEAL KIT

BOTTOM END KIT
Crankshaft • Bearings •
Seals • Gasket Set

HONDA FOUR-STROKE (CONTINUED)

MODEL	Year	AC	H-5597	5597K	78.00	Std.	12.9:1 (05-17) 01.1338A	12.9:1 (05-17) 4829M07800	12.9:1 (05-17) 8587DA	12.9:1 (05-17) VT22983A	13.2:1 (05-17) 247607	Top End C3133-EST (78mm)	Top End 35-1334 ("R" 04-07) ("X" 04-17)	Cylinder Works 10001 (Std. 78mm)	Steel Exhaust 28-13341 (2005-07) 30-31166 (2008-09)	Valve Guide 2005-07 Intake 30-30610	Hot Cams 1039-1 (Stage 1) 1039-2 (Stage 2)	CC-1335	HR4083 ("R" 05-09)	Pro-X 04917	Left 8ENK16	49-822248	Hot Rods CRF250R (04-05) CBK0119						
CRF-250R 2005-09 CRF-250X 2005-17 249cc Liquid Cooled 78mm 3.071" <i>CYLINDER SLEEVING REQUIRED FOR OVERSIZES</i> <i>CYL. WORKS COMPLETE KIT INCLUDES CYLINDER, PISTON, TOP END GASKETS</i>		AC	H-5597	5597K	78.00	Std.	12.9:1 (05-17) 01.1338A	12.9:1 (05-17) 4829M07800	12.9:1 (05-17) 8587DA	12.9:1 (05-17) VT22983A	13.2:1 (05-17) 247607	Top End C3133-EST (78mm)	Top End 35-1334 ("R" 04-07) ("X" 04-17)	Cylinder Works 10001 (Std. 78mm)	Steel Exhaust 28-13341 (2005-07) 30-31166 (2008-09)	Valve Guide 2005-07 Intake 30-30610	Hot Cams 1039-1 (Stage 1) 1039-2 (Stage 2)	CC-1335	HR4083 ("R" 05-09)	Pro-X 04917	Left 8ENK16	49-822248	Hot Rods CRF250R (04-05) CBK0119						
					78.00	Std.	13.5:1 (05-09) 01.1339A	13.5:1 (05-09) 4852M07800	13.5:1 (05-09) 8656DA	13.4:1 (05-09) VT23113A	13.7:1 (05-09) 274178	Cylinder Works C7185-EST (79mm)	35-0268 ("R" 08-09)	Steel Intake 30-30630 Pro-X	Exhaust 30-30620	Hot Rods HR8616	Bearing / Seal Kit (04-06) 49K041 ("R" 07-09) 49K073 ("X" 07-17) 49K073	(06-07) CBK0194											
					78.00	Std.		13.1:1 (08-09) 4949M07800		13:1 (08-09) VT23443A			Cylinder Works Complete Kit 10001-K01 (Std. 78mm) (05-07)	37-1334 ("R" 04-07) ("X" 04-17)	Titanium Intake 28-13342 Kibblewhite Ti EX	Intake 30-31170													
					78.00	Std.		13.6:1 (08-09) 4972M07800		13.5:1 (08-09) VT23444A			10001-K02 (Std. 78mm) (08-09)	37-1268 ("R" 08-09)	30-30633T (2005-07) 30-31166T (2008-09)	Exhaust 30-31180													
					79.00	.040				13.5:1 (05-09) 325013																			
					80.00	.080				221772																			
CRF-250R 2004-09 Big Bore to 262, 270, 280cc 80mm 3.150" 262cc 81mm 3.188" 270cc 82mm 3.228" 280cc <i>CYL. WORKS COMPLETE KIT INCLUDES CYLINDER, PISTON, TOP END GASKETS</i>		BB	H-5597D		80.00	.080		13.5:1 Comp.	13.5:1 Comp. 8656D200	13.1 Comp. VT23535A	13.5:1 Comp. 221772	Top End C7189-EST (81mm)		Cylinder Works Complete Kit 11001-K01 (270cc, 81mm)															
					81.00	.120																							
					82.00	.160		4984M08200	8586D400																				
								H-5731																					

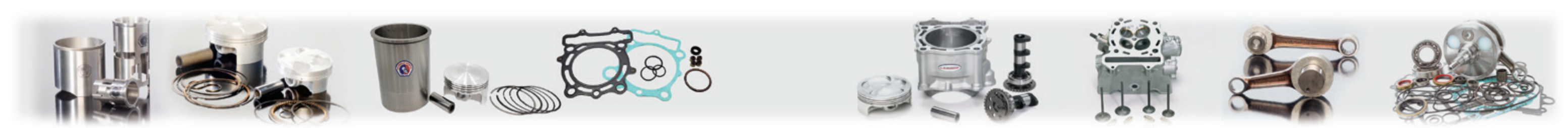

GASGAS
HONDA
HUSQVARNA
KAWASAKI
KTM
SUZUKI
YAMAHA
DIRT BIKE SLEEVES
STREET BIKE SLEEVES
ACCESSORIES
TECHNICAL



MODEL
Engine Description
Cylinder I.D. (mm/in.)



SLEEVE

REBUILD KIT
Sleeve • Piston
Gasket • T.E. Bearing

BORE SIZE (mm)

PISTON SIZE

TOP END

TOP END

VALVE TRAIN

BOTTOM END

PRO-X PISTON

WISECO PISTON

WOSSNER PISTON

VERTEX PISTON

JE PISTON

COMETIC GASKET

L.A. SLEEVE GASKET

CYLINDER AFTERMARKET KITS

VALVE / SPRING KIT

VALVE GUIDE

CAMSHAFT

CAM CHAIN

CRANKSHAFT

CON-ROD KIT

CRANK BEARING

ENGINE OIL SEAL KIT

BOTTOM END KIT
Crankshaft • Bearings •
Seals • Gasket Set

HONDA FOUR-STROKE (CONTINUED)

MODEL	Year	AC	H	5739K	76.80	Std.	13.2:1 (10-13)	13.2:1 (10-13)	14.2:1 (10-13)	13.2:1 (10-13)	13.8:1 (10-13)	Top End	Top End	Cylinder Works	Steel Intake	Valve Guide	Hot Cams	CC-1340	HR4097	Pro-X	Left	49-822357	Hot Rods
CRF-250R	2010-17	AC	H-5739	5739K	76.80	Std.	01.1342A	40003M07680	8775DA	VT23510A	291516	C3288-EST (78mm)	Top End 35-0285	Cylinder Works 10007 (Std. 76.8mm)	Steel Intake 30-31462 (10-15) 30-32412 (16-17)	Valve Guide (10-15) Intake 30-31470	Hot Cams (10-15) 1264-1 (Stage 1)			Pro-X 04917	Left 8ENK16	49-822357	Hot Rods CBK0128
					76.81	Std.	01.1342B	40011M07900	8775DB	VT23510B	315167	C3289-EST (80mm)	Complete w/oil seals 37-1285	Complete Kit (10-13) 10007-K01 (Std. 76.8mm)	Steel Exhaust 30-31466 (10-15) 30-32416 (16-17)	Exhaust 30-31480	1265-2 (Stage 2)			Hot Rods HR8616	Right SX06C62	Bearing / Seal Kit 49K073	
					76.80	Std.	01.1343A	40114M07680	8912DA	VT23961A				Complete Kit (14-15) 10007-K02 (Std. 76.8mm)	Kibblewhite Titanium Intake 30-31462T (10-15) 30-32412T (16-17)	Intake 30-32420	1318-1 (Stage 1)						
					76.81	Std.	01.1343B	40156M07680	8912DB	VT23961B				Complete Kit (16-17) 10007-K03 (Std. 76.8mm)	Titanium Exhaust 30-31466T (10-15) 30-32416T (16-17)	Exhaust 30-32430	1319-2 (Stage 2)						
					76.80	Std.	01.1346A		8925DA	VT24119A	344514				Valve Spring Kit 30-31450 (10-15) 30-32400 (16-17)								
					76.81	Std.	01.1346B		8925DB	VT24119B					Complete Head Service Kit ("R" 10-15) 30-33310 ("R" 16-17) 30-33320 Includes Std. Valves, Guides, Spring Kit, Seals, Gaskets								
CRF-250R	2010-17	BB	H-5739B		79.00	.086		13.2:1 Comp. 40011M07900	14.2:1 Comp. 8775D220	13.3:1 Comp. VT23653A		Top End C3289-EST (80mm)		Complete Kit 11007-K01 (270cc, 80mm)									
					80.00	.125																	
CRF-250R	2018-24	AC	H-5803		79.00	Std.	01.1348A	40202M07900	8952DA	VT24273A	355532	Top End C3635	Top End 35-0030 (18-21)	Cylinder Works 10011 (Std. 79mm) (18-24)	Steel Intake (18-23) 30-33612	Valve Guide (18-23) Intake 30-33620		CC-1348		Pro-X 03.1348		49-822996	
CRF-250RX	2019-24				79.01	Std.	01.1348B		8952DB	VT24273B			35-0047 (22-24)	Complete Kit (18-19) 10011-K01 (Std. 79mm)	Steel Exhaust (18-23) 30-33616	Exhaust 30-33630				Wossner WR4077			
					79.00	Std.	01.1350A	40249M07900	8967DA	VT24516A	373035		Complete w/oil seals 37-0030 (18-21)	10011-K02 (20-21) 10011-K02 (Std. 79mm)	Titanium Intake (18-23) 30-33612T	Valve Seals (18-21) Pkg. of 4 71015-4							
					79.01	Std.	01.1350B		8967DB	VT24516B			37-0050 (22-23)	10011-K03 (22-24) 10011-K03 (Std. 79mm)	Titanium Exhaust (18-23) 30-33616T	Valve Seals (22-23) Pkg. of 4 35.VS004							
					79.00	Std.			13.9:1 (22-24) VT24575A VT24575B						Valve Spring Kit (18-21) 30-33600								
XL-250R	1984-85	RS	H-842		75.00	Std.		10.5:1 Comp. 4329M07500	10.2:1 Comp. 8792DA						Steel Intake 30-30081	Valve Guide (IN / EX) 30-3100		CC-1384					
XR-250R	1984-85				75.50	.020		4329M07550	8792D050						Steel Exhaust 30-30083								
					76.00	.040		4329M07600	8792D100						Spring Kit 30-30077								

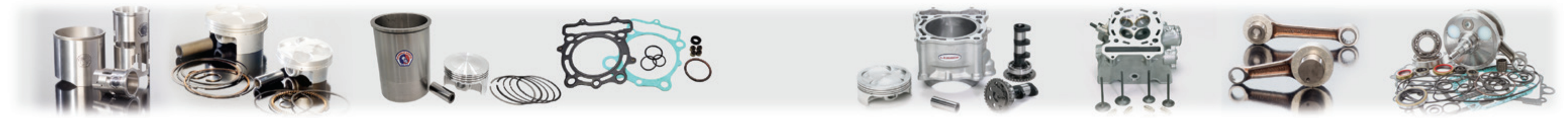

GASGAS
HONDA
HUSQVARNA
KAWASAKI
KTM
SUZUKI
YAMAHA
DIRT BIKE SLEEVES
STREET BIKE SLEEVES
ACCESSORIES
TECHNICAL



MODEL
Engine Description
Cylinder I.D. (mm/in.)



SLEEVE

REBUILD KIT
Sleeve • Piston
Gasket • T.E. Bearing

BORE SIZE (mm)

PISTON SIZE

TOP END

TOP END

VALVE TRAIN

BOTTOM END

PRO-X PISTON

WISECO PISTON

WOSSNER PISTON

VERTEX PISTON

JE PISTON

COMETIC GASKET

L.A. SLEEVE GASKET

CYLINDER AFTERMARKET KITS

VALVE / SPRING KIT

VALVE GUIDE

CAMSHAFT

CAM CHAIN

CRANKSHAFT

CON-ROD KIT

CRANK BEARING

ENGINE OIL SEAL KIT

BOTTOM END KIT
Crankshaft • Bearings • Seals • Gasket Set

HONDA FOUR-STROKE (CONTINUED)

MODEL	Year	Configuration	Cylinder I.D. (mm/in.)	Stroke (mm)	Compression Ratio	PRO-X PISTON	WISECO PISTON	WOSSNER PISTON	VERTEX PISTON	JE PISTON	COMETIC GASKET	L.A. SLEEVE GASKET	CYLINDER AFTERMARKET KITS	VALVE / SPRING KIT	VALVE GUIDE	CAMSHAFT	CAM CHAIN	CRANKSHAFT	CON-ROD KIT	CRANK BEARING	ENGINE OIL SEAL KIT	BOTTOM END KIT	
XL-250R RFVC 249cc 75mm	1986-87 Single 2.953"	RS H-5312	75.00 75.50 76.00	Std. .020 .040			10.5:1 Comp. 4329M07500 4329M07550 4329M07600	10.2:1 Comp. 8792DA 8792D050 8792D100						Steel Intake 30-30081 Steel Exhaust 30-30083 Spring Kit 30-30077	Valve Guide (IN / EX) 30-3100 O/S+.002 30-3102								
XR-250R RFVC 249cc 73mm	1986-04 Single 2.874"	RS H-957	73.00 73.50 74.00	Std. .020 .040			10.5:1 Comp. 4466M07300 4466M07350 4466M07400	10.5:1 Comp. 8793DA 8793D050 8793D100		Top End C7821		Top End 35-0258 (XR250L) ("R" 86-95)		Steel Intake 30-30081 (XR250L) ("R" 86-95) 30-30073 ("R" 96-04)	Valve Guide (IN / EX) 30-3100 O/S+.002 30-3102	Hot Cams 1006-1 ("R" 96-04)	CC-1384 ("R" 86-95) CC-1396 ("R" 96-04)	Pro-X 01356	Right 6328C3 (86-95) B32872 (96-04)	49-822219 ("L" 91-96) ("R" 86-95) 49-822220 ("R" 96-04)			
Big Bore to 285cc 75.5mm to 78mm		BB H-957B	75.50 77.00 78.00	.100 .160 .200			10.5:1 Comp. 4466M07550 4466M07700 4466M07800	11.2:1 Comp. 8793D250 8793D400 8793D500		Top End C7822 (78mm)		35-0263 ("R" 96-04) Complete w/oil seals 37-1258 37-1263 ("R" 96-04)		Steel Exhaust 30-30083 (XR250L) ("R" 86-95) 30-30075 ("R" 96-04) Spring Kit 30-30077 (84-95) 30-30070 ("R" 96-04)	Valve Guide (IN / EX) 30-30060 ("R" 96-04) Valve Seals Pkg. of 4 71016-4								
XL-350R 339cc 84mm (Sleeve O.D. 3.510")	1983-84 Single 3.307"	RS/MO H-119																					
XR-350R 339cc 84mm (Sleeve O.D. 3.549")	1983-85 Single 3.307"	RS H-943	84.00 84.50 85.00	Std. .020 .040			4286M08400 4286M08450 4286M08500 (83-84)																
XR-400R 397cc 85mm	1996-04 Single 3.346"	RS H-5293	85.00 85.25 85.50 85.75 86.00 87.00	Std. .010 .020 .030 .040 .080	9.3:1 Comp. 2500 2501 2502 2503 2504	10:1 Comp. 4606M08500 4606M08550 4606M08600 4606M08700	10:1 Comp. 8604DA 8604D050 8604D100 8604D200	9.3:1 Comp. VT23162 VT23162050 VT23162100	10.5:1 Comp. 132697 132699 133889	Top End C7825-EST (86mm) C7826-EST (89mm)		Top End 35-1495 Complete w/oil seals 37-1495 (1996-98) 37-1266 (1999-04)	Steel Exhaust 28-14951 Steel Intake 28-14952 Valve Spring Kit 30-30085	Valve Guide (IN / EX) 30-3120 O/S+.002 30-3122	Hot Cams Camshaft 1007-1 (Stage 1) 1043-2 (Stage 2)	CC-1496	Pro-X 01565	692C3	49-822161				
XR-400R Big Bore Sleeve 426cc, 435cc, 445cc 88mm 3.346" 426cc 89mm 3.503" 435cc 90mm 3.543" 445cc	1996-04	BB H-5445	88.00 88.00 89.00 89.00	.120 .120 .160 .160		10:1 Comp. 4606M08800 4628M08800 4667M08900	10:1 Comp. 8604D300 8604D400		11:1 Comp. 177240 247612	Top End C7826-EST (89mm)			Steel Exhaust 28-14951 Steel Intake 28-14952 Valve Spring Kit 30-30085		Hot Cams Camshaft 1043-2 (Stage 2)	CC-1496	Pro-X 01565						
			89.00	.160		12.5:1 Comp. 4794M08900			12:1 Comp. 208552														

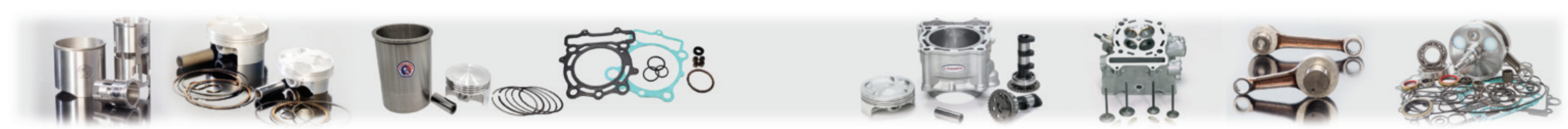

GASGAS
HONDA
HUSQVARNA
KAWASAKI
KTM
SUZUKI
YAMAHA
DIRT BIKE SLEEVES
STREET BIKE SLEEVES
ACCESSORIES
TECHNICAL



MODEL
Engine Description
Cylinder I.D. (mm/in.)

SLEEVE				TOP END							TOP END		VALVE TRAIN				BOTTOM END					
REBUILD KIT Sleeve • Piston Gasket • T.E. Bearing	BORE SIZE (mm)	PISTON SIZE		PRO-X PISTON	WISECO PISTON	WOSSNER PISTON	VERTEX PISTON	JE PISTON	COMETIC GASKET	L.A. SLEEVE GASKET	CYLINDER AFTERMARKET KITS	VALVE / SPRING KIT	VALVE GUIDE	CAMSHAFT	CAM CHAIN	CRANKSHAFT	CON-ROD KIT	CRANK BEARING	ENGINE OIL SEAL KIT	BOTTOM END KIT Crankshaft • Bearings • Seals • Gasket Set		

HONDA FOUR-STROKE (CONTINUED)

CRF-450R 2002-03 449cc Liquid Cooled 96mm 3.779" <i>RESLEEVEING REQUIRED FOR OVERSIZES</i> <i>CYL. WORKS COMPLETE KIT INCLUDES CYLINDER, PISTON, TOP END GASKETS</i>	AC	H-5475	5475K	96.00	Std.	11.5:1 Comp.	11.5:1 Comp.	12:1 Comp.	11.5:1 Comp.	Top End C3047-EST	Top End 35-1402 Complete w/oil seals 37-1402	Cylinder Works 10002 (Std. 96mm)	Steel Exhaust 28-14021 Titanium Exhaust 30-30223T	Valve Guide Intake 30-30200 Exhaust 30-30210	Hot Cams Camshaft 1016-1 (Stage 1) 1024-2 (Stage 2)	CC-1403	HR4048	Pro-X 04935 Hot Rods HR8617	Left 2MEB671 Right SX06C42	49-822178	Hot Rods CBK0086						
				96.01	.080	4090A	4753M09600	8546DA	VT22814A													Cylinder Works Complete Kit 10002-K01 (Std. 96mm)	Steel Intake 30-30220 Titanium Intake 28-14022	Valve Seals Pkg. of 4 30-30550	Complete Head Service Kit 30-33340 <i>Includes Std. Valves, Guides, Spring Kit, Seals, Gaskets</i>		
				96.00	Std.	4090B	4820M09600	8546DB	VT22814B																		
				96.00	Std.	4098	4755M09600		VT22900A																	12.5:1 Comp. 274755	
				96.00	Std.	4098	4822M09600																			12.5:1 Comp. 274756	
96.00	Std.	4098	4823M09600	13.5:1 Comp. 8668DA		13.5:1 Comp. 274756																					
CRF-450R 2002-03 Big Bore to 470, 480, 490cc 98mm 3.858" 468cc 99mm 3.898" 477cc 100mm 3.937" 488cc 101mm 3.976" 497cc	BB	H-5475B 98mm-100mm H-5475BB 101mm (Wet Liner)		98.00	.080	12.5:1 Comp.	12.5:1 Comp.	12.5:1 Comp.	12:1 Comp.	Top End C3049-EST (99mm)	Top End GS5475 (100mm)	Cylinder Works Complete Kit 11002-K01 (488cc)	Steel Exhaust 28-14021 Titanium Exhaust 30-30223T	Hot Cams Camshaft 1024-2 (Stage 2)	CC-1403	HR4048	Pro-X 04935 Hot Rods HR8617	Left 2MEB671 Right SX06C42	49-822178	Hot Rods CBK0086							
				99.00	.120	4698	4755M09800	8546D400A	VT23595A												Cylinder Works CRF-R 10002 (Std. 96mm)	Steel Intake 30-30220 Titanium Intake 28-14022	Valve Spring Kit 30-30640				
				100.00	.160	4699	4755M09900		VT22966A															Cylinder Works Complete Kit 10002-K01 (Std. CRF-R)	Steel Exhaust 28-14021 (04-06) 28-14071 (07-08)	Exhaust 30-30210	
				101.00	.200	46100	4890M10100																				CRF-X 10008 (Std. CRF-X)
CRF-450R (MEB) 2004-08 CRF-450X 2005-17 449cc Liquid Cooled 96mm 3.779" <i>RESLEEVEING REQUIRED FOR OVERSIZES</i> <i>CYL. WORKS COMPLETE KIT INCLUDES CYLINDER, PISTON, TOP END GASKETS</i>	AC	H-5537	5537K (R 04-06) 5537K-2 (R 07-08) CRF-X 5537K-3	96.00	Std.	12:1 Comp.	12:1 Comp.	12:1 Comp.	12:1 Comp.	Top End CRF-R C3047-EST (96mm)	Top End 35-1402 ("R" 04-06) 35-0278 ("R" 07-08) 35-0276 (CRF-X) Complete w/oil seals 37-1402 ("R" 04-06) 37-1278 ("R" 07-08) 37-1276 (CRF-X)	Cylinder Works CRF-R 10002 (Std. 96mm)	Steel Exhaust 28-14021 (04-06) 28-14071 (07-08)	Valve Guide CRF-R Intake 30-30200 Exhaust 30-30210	Camshaft CRF-R Stage 1 1016-1 (04-06) 1076-1 (07) 1101-1 (08) Stage 2 1024-2 (04-06) 1077-2 (07) 1102-2 (08)	CC-1403	CRF-R HR4048 CRF-X HR4070	Pro-X CRF-R 04935 CRF-X 03.1405 Hot Rods CRF-R HR8617 CRF-X HR8660	Left 2MEB671 Right SX06C42	49-822178 ("R" 04-06) 49-822330 ("R" 07-08)	Hot Rods CRF450R (04-05) CBK0086 (06) CBK0175 (07-08) CBK0017 CRF450X (05-16) CBK0105						
				96.01	.080	4690A	4820M09600	8608DA	VT23003A													Cylinder Works Complete Kit 10002-K01 (Std. CRF-R)	Steel Exhaust 30-31066	Valve Seals Pkg. of 4 30-30550			
				96.00	Std.	4698	4755M09600	8608DB	VT23003B																CRF-X 10008 (Std. CRF-X)	Titanium Intake CRF-R 28-14022 CRF-X 28-14052	CRF-X Intake 30-31070
				96.00	Std.	4698	4822M09600		VT22900A																CRF-X 10008 (Std. CRF-X)	Titanium Exhaust 30-30223T ("R" 04-06) 30-30225T ("R" 07-08)	CRF-X Intake 30-31070 Exhaust 30-31080
CRF-450R (MEB) 2004-08 CRF-450X 2005-17 Big Bore to 470, 480, 490cc 98mm 3.858" 468cc 99mm 3.898" 477cc 100mm 3.937" 488cc 101mm 3.976" 497cc <i>CYL. WORKS COMPLETE KIT INCLUDES CYLINDER, PISTON, TOP END GASKETS</i>	BB	H-5537B 98mm-100mm H-5537BB 101mm, 497cc (Wet Liner)		98.00	.080	12.5:1 Comp.	12.5:1 Comp.	12:1 Comp.	12.5:1 Comp.	Top End CRF-R C3049-EST (99mm)	Top End CRF-R GS5475 (100mm)	Cylinder Works CRF-R Complete Kit 11002-K01 (488cc, 100mm)															
				99.00	.120	4698	4755M09800		VT23595A													Cylinder Works CRF-R Complete Kit 11008-K01 (478cc, 99mm)					
				100.00	.160	4699	4755M09900		VT22966A																Cylinder Works CRF-R Complete Kit 11008-K01 (478cc, 99mm)		
				101.00	.200	46100	4890M10100																				

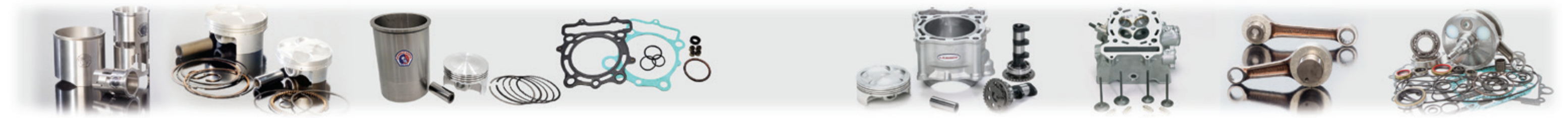

GASGAS
HONDA
HUSQVARNA
KAWASAKI
KTM
SUZUKI
YAMAHA
DIRT BIKE SLEEVES
STREET BIKE SLEEVES
ACCESSORIES
TECHNICAL



MODEL
Engine Description
Cylinder I.D. (mm/in.)



SLEEVE

REBUILD KIT
Sleeve • Piston
Gasket • T.E. Bearing

BORE SIZE (mm)

PISTON SIZE

TOP END

TOP END

VALVE TRAIN

BOTTOM END

PRO-X PISTON

WISECO PISTON

WOSSNER PISTON

VERTEX PISTON

JE PISTON

COMETIC GASKET

L.A. SLEEVE GASKET

CYLINDER AFTERMARKET KITS

VALVE / SPRING KIT

VALVE GUIDE

CAMSHAFT

CAM CHAIN

CRANKSHAFT

CON-ROD KIT

CRANK BEARING

ENGINE OIL SEAL KIT

BOTTOM END KIT
Crankshaft • Bearings • Seals • Gasket Set

HONDA FOUR-STROKE (CONTINUED)

MODEL	Year	AC	Model	96.00	Std.	12:1 Comp.	12:1 Comp.	12.2:1 Comp.	12:1 Comp.	Top End	Top End	Cylinder Works	Steel Exhaust	Valve Guide	CC-1419	49-822378			
CRF-450L CRF-450RL CRF-450X 449cc Liquid- Cooled 96mm 3.779"	2019-20 2021-24 2019-24	AC	H-5801	96.00 96.01	Std. Std.	01.1419A 01.1419B	40239M09600	8968DA 8968DB	VT24594A VT24594B	Top End C3733	Top End 35-0012 Complete w/oil seals 37-1035	Cylinder Works 10010-1 (Std. 96mm) Complete Kit 10010-K04 (Std. 96mm) Cylinder Works Complete Kit Big Bore 478cc 11010-K04 (478cc, 99mm)	Steel Exhaust 30-32816K Steel Intake 30-32812H Titanium Intake 30-32812T Valve Spring Kit 30-32800	Valve Guide Intake 30-32820 Exhaust 30-32830 Valve Seals Pkg. of 4 71015-4			Bearing / Seal Kit 49K095 (19-20)		
XL, XR-500 498cc 89mm	1979-82 Single 3.504"	RS	H-5	89.00 89.50 90.00 90.50 91.00	Std. .020 .040 .060 .080	01.1509.000 01.1509.050 01.1509.100 01.1509.150 01.1509.200	4117M08900 4117M09000 4117M09100	8642D050 8642D100 8642D150 8642D200		Top End C7147							6307C3		
570cc Big Bore 95mm 3.740"		BB	H-5B	95.00	.240		4117M09500			Top End C7148									
XR-500 497cc 92mm	1983-84 Single Radial 3.622"	RS	H-839	92.00 92.50 93.00	Std. .020 .040		10.25:1 Comp. 4330M09200 4330M09250 4330M09300			Top End C7238								6307C3	
XL-600 R 589cc 100mm	1983-87 Single 3.937"	RS	H-120	100.00 100.50 101.00 102.40	Std. .020 .040 .095		11:1 Comp. 4332M10000 4332M10100 4332M10241	10.2:1 Comp. 8822DA 8822D050 8822D100		Top End C7149			Spring Kit 30-30015	Valve Guide IN / EX 30-3050 O/S+.001 30-3051			Pro-X 01563 Hot Rods HR8118	Left 6308X Right 6307X	
XR-600R 591cc 97mm	1985-87 Single 3.818"	RS	H-960	960K-1 (9:1) 97.00 97.25 97.50 97.75 98.00	Std. .010 .020 .030 .040	9:1 Comp. 4660 4661 4662 4663 4664	9:1 Comp. 4577M09700 4577M09750 4577M09800	9.3:1 Comp. 8574DA 8574D050 8574D100		Top End C7827	Top End 35-1654 Complete w/oil seals 37-1654		Steel Exhaust 28-16541 Steel Intake 28-16542 Spring Kit 30-30015	Valve Guide IN / EX 30-3050 O/S+.001 30-3051			Pro-X 01563 Hot Rods HR8118	Left 6308C3 Right 6307X	
XR-600R 591cc 97mm	1988-90 Single 3.818"	AC	H-5037	5037K-1 (9:1) 97.00 97.25 97.50 97.75 98.00	Std. .010 .020 .030 .040	9:1 Comp. 4660 4661 4662 4663 4664	9:1 Comp. 4577M09700 4577M09750 4577M09800	9.3:1 Comp. 8574DA 8574D050 8574D100		Top End C7827	Top End 35-1654 Complete w/oil seals 37-1654		Steel Exhaust 28-16541 Steel Intake 28-16542 Spring Kit 30-30015	Valve Guide IN / EX 30-3050 O/S+.001 30-3051	Camshaft 1004-1		Pro-X 01563 Hot Rods HR8118	Left 6308C3 Right 6307X	49-822164
XR-600R Big Bore 628cc 100mm	1988-90 Single 3.937"	BB	H-5037B	100.00 101.00 102.00	.120 .160 .200		9.3:1 Comp. 8574D300 8574D400 8574D500		10.5:1 Comp. 128995 128996 128998	Top End C7828			Steel Exhaust 28-16541 Steel Intake 28-16542 Kibblewhite Valve Spring Kit 30-30015	Valve Guide IN / EX 30-3050 O/S+.001 30-3051	Camshaft 1004-1		Pro-X 01563 Hot Rods HR8118	Left 6308C3 Right 6307X	

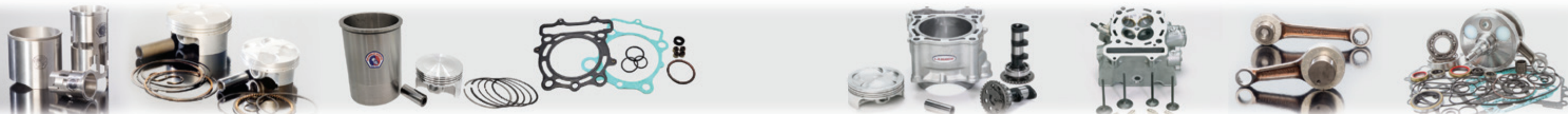

GASGAS
HONDA
HUSQVARNA
KAWASAKI
KTM
SUZUKI
YAMAHA
DIRT BIKE SLEEVES
STREET BIKE SLEEVES
ACCESSORIES
TECHNICAL



MODEL
Engine Description
Cylinder I.D. (mm/in.)



SLEEVE

REBUILD KIT
Sleeve • Piston
Gasket • T.E. Bearing

BORE SIZE (mm)

PISTON SIZE

TOP END

TOP END

VALVE TRAIN

BOTTOM END

PRO-X PISTON

WISECO PISTON

WOSSNER PISTON

VERTEX PISTON

JE PISTON

COMETIC GASKET

L.A. SLEEVE GASKET

CYLINDER AFTERMARKET KITS

VALVE / SPRING KIT

VALVE GUIDE

CAMSHAFT

CAM CHAIN

CRANKSHAFT

CON-ROD KIT

CRANK BEARING

ENGINE OIL SEAL KIT

BOTTOM END KIT
Crankshaft • Bearings • Seals • Gasket Set

HONDA FOUR-STROKE (CONTINUED)

MODEL	Year	Configuration	Stroke	Cylinder I.D. (mm)	Stroke (mm)	Compression Ratio	9:1 Comp. Piston	9:1 Comp. Piston	9.3:1 Comp. Piston	10.5:1 Comp. Piston	Top End Part	Top End Part	Valve Train	Valve Train	Camshaft	CC	Bottom End Part	Bottom End Part	Bottom End Part	Bottom End Part						
XR-600R 591cc 97mm	1991-00	Single 3.818"	RS	H-5159	5159K-1 (9:1)	97.00 97.25 97.50 97.75 98.00	Std. .010 .020 .030 .040	9:1 Comp. 4660	9:1 Comp. 4577M09700	9.3:1 Comp. 8574DA	Top End C7827	Top End 35-1654	Steel Exhaust 28-16541	Valve Guide IN / EX 30-3050	Camshaft 1004-1	CC-1654 (93-00)	Pro-X 01563	Left 6308C3	49-822164							
								4661	4577M09750	8574D050											4662	4577M09800	8574D100	Complete w/oil seals 37-1654	Steel Intake 28-16542	O/S+.001 30-3051
XR-600R Big Bore XR-628R Honda Kit 628cc 100mm	1985-87 1988-95	Single 3.937"	RS	H-5160	100.00	.120		11:1 Comp. 4366M09700			Top End C7828		Steel Exhaust 28-16541		Camshaft 1004-1		Pro-X 01563	Left 6308C3								
								4366M09750													9.3:1 Comp. 8574D300	10.5:1 Comp. 128995	Steel Intake 28-16542		Hot Rods HR8118	Right 6307X
								4366M09800													8574D400					
XR-650L 644cc 100mm	1993-23	Single 3.937"	RS	H-5160	5160K	100.00 100.50 101.00 102.00 102.40	Std. .020 .040 .080 .095	8.3:1 Comp. 01.1660.000	8.7:1 Comp. 4562M10000	8.3:1 Comp. 8564DA	Top End C3216 (103mm)	Top End 35-0281	Steel Exhaust 28-16541	Valve Guide IN / EX 30-3050	Camshaft 1004-1	CC-1654	Pro-X 01564	Left 6308A	49-822165							
								01.1660.050	4562M10100	8564D100											11.25:1 Comp. 130682	Complete w/oil seals 37-1281	Steel Intake 28-16542	O/S+.001 30-3051	Kibblewhite Valve Spring Kit 30-30015	Right 6307A
								01.1660.100	4562M10241	8564D200																
																					139550					
XR-650L to 720cc 105mm	1993-23	4.134"	BB	H-5160B						Top End GS5160		Complete Head Service Kit 30-33490 (93-18) Includes Std. Valves, Guides, Spring Kit, Seals, Gaskets														
XR-650R 649cc Single Liquid Cooled 100mm	2000-07	Single 3.937"	AC	H-5440	5440K	100.00 100.01 102.40	Std. Std. .095	10:1 Comp. 4700A	10:1 Comp. 4715M10000		Top End C7681 (101mm)		Steel Exhaust 30-30168	Valve Guide Intake 30-30170	Camshaft 1009-1 (Stage 1)	CC-1661	Pro-X 04915	Left 6308A								
								4700B	4715M10240												11:1 Comp. 4716M10000	11:1 Comp. 8718DA	11:1 Comp. 190682	C7753 (103mm)	Steel Intake 30-30166	O/S+.001 30-30171
CYLINDER SLEEVING REQUIRED FOR OVERSIZES																										

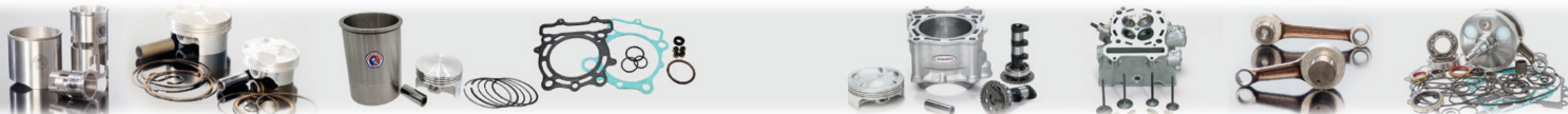

GASGAS
HONDA
HUSQVARNA
KAWASAKI
KTM
SUZUKI
YAMAHA
DIRT BIKE SLEEVES
STREET BIKE SLEEVES
ACCESSORIES
TECHNICAL



MODEL
Engine Description
Cylinder I.D. (mm/in.)



SLEEVE

REBUILD KIT
Sleeve - Piston
Gasket - T.E. Bearing

BORE SIZE (mm)

PISTON SIZE

TOP END

TOP END

BOTTOM END

PRO-X PISTON

WISECO PISTON

WOSSNER PISTON

VERTEX PISTON

T.E. BEARING

COMETIC GASKET

L.A. SLEEVE GASKET

CRANKSHAFT

CON-ROD KIT

CON-ROD ASSEMBLY
Rod - Bearings - Seals

CRANK BEARING

CRANK SEAL KIT

BOTTOM END KIT
Crankshaft - Bearings - Seals - Gasket Set

HUSQVARNA TWO-STROKE

TC 50 49cc 39.5mm	2017-23 Liquid Cooled 1.555"	AC	FL-5746		39.50 39.51 41.50	Std. Std. .080	6019A 6019B	874M03950 874M03950	8262DA 8262DB	VT23429AB		T.E. Bearing B1041	Top End C3503	Top End 35-0337 Complete with Oil Seals 37-1337	HR4401	Pro-X 03.6011		Bearing / Seal Kit 49K083		
TC 65 64.8cc 45mm	2017-23 Liquid Cooled 1.772"	AC	FL-5747	5747K	45.00 45.01	Std. Std.	6029A 6029B	864M04500	8241DA 8241DB	VT23430AB VT23430CD		T.E. Bearing B1042	Top End C3416	Top End 35-0338 Complete with Oil Seals 37-1338	HR4031	Pro-X 03.6029	39-6029	6304JR2 096029	Bearing / Seal Kit 49K083	Hot Rods (18-19) CBK0073
TC 85 85cc 47mm	2014-17 Liquid Cooled 1.850"	AC	FL-5551	5551K-1	47.00 47.01	Std. Std.	6105A 6105B	855M04700	8147DA 8147DB	VT24212A VT24212B		T.E. Bearing 01154	Top End C3510	Top End 35-0340 Complete with Oil Seals 37-1340	HR4023	Pro-X 03.6113	39-6113	Left NJ205 Right 6304/22	096103	Hot Rods CBK0187
TC 85 85cc 47mm	2018-24 Liquid Cooled 1.850"	AC	FL-5796	5796K	47.00 47.01	Std. Std.	6105A 6105B	855M04700	8147DA 8147DB	VT24212A VT24212B		T.E. Bearing 01154	Top End C3636	Top End 35-6024 Complete with Oil Seals 37-0028 (18-21)	(18-21) HR00176	Pro-X 03.6113	39-6113	Left NJ205 Right 6304/22	096103	Hot Rods CBK0187
<i>CYLINDER SLEEVING REQUIRED FOR OVERSIZES</i>																				
WXE, WXC-125 124cc 56mm	1991-92 Liquid Cooled 2.204"	AC	FL-5186																	
WXE, WXC-125 124cc 56mm	1994-95 Liquid Cooled 2.204"	AC	FL-5203																	
WXE, WXC-125 124cc 56mm	1996-97 Liquid Cooled 2.204"	AC	FL-5320																	
CR, WR125 125cc 54mm	1999 Liquid Cooled 2.204"	AC	FL-5389		54.00 54.01 54.50 55.00	Std. Std. .020 .040	6217A 6217B		8089DA 8089DB 8089D050 8089D100 (97-12)			T.E. Bearing 01152	Top End C7734			Pro-X 04927		6322X (97-12)		
CR, WR125 125cc 54mm	2000 Liquid Cooled 2.126"	AC	FL-5452	5452K	54.00 54.01 54.50 55.00	Std. Std. .020 .040	6217A 6217B	760M05400	8089DA 8089DB 8089D050 8089D100 (97-12)			T.E. Bearing 01152	Top End C7734			Pro-X 04927		6322X (97-12)		
CR, WR125 125cc 54mm	2001-02 Liquid Cooled 2.126"	AC	FL-5453	5453K	54.00 54.01 54.50 55.00	Std. Std. .020 .040	6217A 6217B	760M05400	8089DA 8089DB 8089D050 8089D100 (97-12)			T.E. Bearing 01152	Top End C7734			Pro-X 04927 (99-12)		6322X (97-12)		
CR, WR125 125cc 54mm	2003-08 Liquid Cooled 2.126"	AC	FL-5544	5544K	54.00 54.01 54.50 55.00	Std. Std. .020 .040	6217A 6217B	760M05400	8089DA 8089DB 8089D050 8089D100 (97-12)			T.E. Bearing 01152	Top End C7734			Pro-X 04927 (99-12)		6322X (97-12)		
<i>CYLINDER SLEEVING REQUIRED FOR OVERSIZES</i>																				

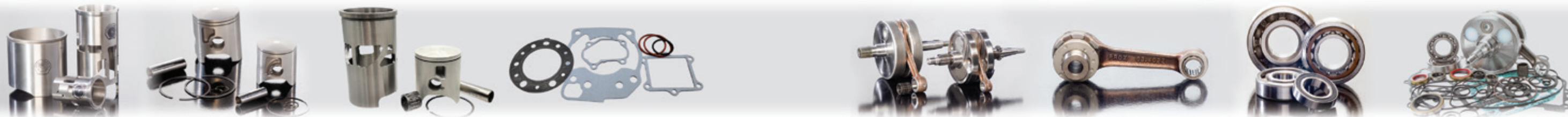

GASGAS
HONDA
HUSQVARNA
KAWASAKI
KTM
SUZUKI
YAMAHA
DIRT BIKE SLEEVES
STREET BIKE SLEEVES
ACCESSORIES
TECHNICAL



MODEL
Engine Description
Cylinder I.D. (mm/in.)

SLEEVE

REBUILD KIT
Sleeve - Piston
Gasket - T.E. Bearing

BORE SIZE (mm)

PISTON SIZE

TOP END

TOP END

BOTTOM END

PRO-X PISTON

WISECO PISTON

WOSSNER PISTON

VERTEX PISTON

T.E. BEARING

COMETIC GASKET

L.A. SLEEVE GASKET

CRANKSHAFT

CON-ROD KIT

CON-ROD ASSEMBLY
Rod - Bearings - Seals

CRANK BEARING

CRANK SEAL KIT

BOTTOM END KIT
Crankshaft - Bearings - Seals - Gasket Set

HUSQVARNA TWO-STROKE (CONTINUED)

TC 125 TE 125 125cc 54mm Liquid Cooled 2.126" CYLINDER SLEEVING REQUIRED FOR OVERSIZES	2014-15	AC	FL-5692	5692K	54.00 54.01 56.00	Std. Std. .080	6226A 6226B (Double Ring)	786M05400 (Single Ring)	8220DA 8220DB 8220D200 (Single Ring)	VT23928A VT23928B (Double Ring)		T.E. Bearing 01153	Top End C3211	Top End 35-0330 Complete with Oil Seals 37-1309	(TC) HR4024	Pro-X 04997	39-6218	Left NJ206 Right 6305JR2	096218	Hot Rods (TC) CBK0004
Bearing / Seal Kit 49-62001																				
TC 125 125cc 54mm Liquid Cooled 2.126" CYLINDER SLEEVING REQUIRED FOR OVERSIZES	2016-22	AC	FL-5804	5804K	54.01 54.01 56.00	Std. Std. .080	6226A 6226B (Double Ring)	786M05400 (Single Ring)	8220DA 8220DB 8220D200 (Single Ring)	VT23928A VT23928B (Double Ring)		T.E. Bearing 01153	Top End C3606	Top End 35-6009	HR00177	Pro-X 03.6226 Hot Rods HR8174	39-6226	Left NJ206 Right 6305JR2	096218	
Bearing / Seal Kit 49-62001																				
TE 150 TE 150I 150cc 58mm Liquid Cooled 2.283"	2017-19 2020	AC	FL-5805	5805K	58.00 58.01	Std. Std.	6237A 6237B	881M05800	8311DA 8311DB	VT24101A VT24101B		T.E. Bearing 01153	Top End C3606	Top End 35-0370 Complete with Oil Seals 37-1370		Pro-X 03.6226 Hot Rods HR8174	39-6226	Left NJ206 Right 6305JR2	096218	
Bearing / Seal Kit 49-62001																				
TE 150I 150cc 58mm Liquid Cooled 2.283"	2021-23	AC	FL-5805	5805K-1	58.00 58.01	Std. Std.	6241A 6241B	897M05800	8311DA 8311DB	VT24519A VT24519B		T.E. Bearing 01153	Top End C3606	Top End 35-0370 Complete with Oil Seals 37-1370		Pro-X 03.6226		Left NJ206 Right 6305JR2	096218	
Bearing / Seal Kit 49-62001																				
WXE, WXE-250 249cc 67mm Liquid Cooled 2.637" CYLINDER SLEEVING REQUIRED FOR OVERSIZES	1993	AC	FL-5204		67.00 67.50 68.00	Std. .020 .040		699M06700 699M06750 699M06800				T.E. Bearing 01181	Top End W5565							
WXE, WXE-250 249cc 67mm Liquid Cooled 2.637" CYLINDER SLEEVING REQUIRED FOR OVERSIZES	1994	AC	FL-5205		67.00 67.50 68.00	Std. .020 .040		699M06700 699M06750 699M06800				T.E. Bearing 01181	Top End W5565							
CR, WR-250 249cc 67mm Liquid Cooled 2.614" CYLINDER SLEEVING REQUIRED FOR OVERSIZES	1999	AC	FL-5390		66.40	Std.	6430A	761M06640	8141DA			T.E. Bearing 01181	Top End C7743			Pro-X 04926		6305C3 (97-12)		
CR, WR-250 249cc 66.4mm Liquid Cooled 2.614" CYLINDER SLEEVING REQUIRED FOR OVERSIZES	2000	AC	FL-5444		66.40	Std.	6430A	761M06640	8141DA			T.E. Bearing 01181	Top End C7743			Pro-X 04926		6305C3 (97-12)		
CR, WR-250 249cc 66.4mm Liquid Cooled 2.614" CYLINDER SLEEVING REQUIRED FOR OVERSIZES	2001-02	AC	FL-5454		66.40	Std.	6430A	761M06640	8141DA			T.E. Bearing 01181	Top End C7743			Pro-X 04926		6305C3 (97-12)		
CR-250 WR-250 249cc 66.4mm Liquid Cooled 2.614" CYLINDER SLEEVING REQUIRED FOR OVERSIZES	2003-05 2003-13	AC	FL-5545		66.40	Std.	6430A (99-12)	761M06640	8141DA (03-13)			T.E. Bearing 01181	Top End C7743 (99-10)			Pro-X 04926 (99-12)		6305C3 (99-12)		

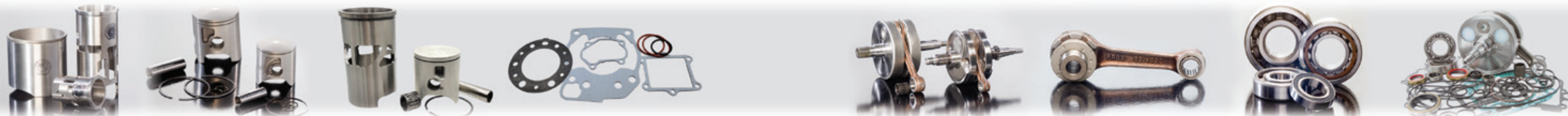

GASGAS
HONDA
HUSQVARNA
KAWASAKI
KTM
SUZUKI
YAMAHA
DIRT BIKE SLEEVES
STREET BIKE SLEEVES
ACCESSORIES
TECHNICAL



MODEL
Engine Description
Cylinder I.D. (mm/in.)



SLEEVE

REBUILD KIT
Sleeve - Piston
Gasket - T.E. Bearing

BORE SIZE (mm)

PISTON SIZE

TOP END

TOP END

BOTTOM END

PRO-X PISTON

WISECO PISTON

WOSSNER PISTON

VERTEX PISTON

T.E. BEARING

COMETIC GASKET

L.A. SLEEVE GASKET

CRANKSHAFT

CON-ROD KIT

CON-ROD ASSEMBLY
Rod - Bearings - Seals

CRANK BEARING

CRANK SEAL KIT

BOTTOM END KIT
Crankshaft - Bearings - Seals - Gasket Set

HUSQVARNA TWO-STROKE (CONTINUED)

MODEL	Year	AC	FL	Part No.	Stroke	Std. Bore	Std. Piston	Pro-X Piston	Wiseco Piston	Wossner Piston	Vertex Piston	T.E. Bearing	Cometic Gasket	L.A. Sleeve Gasket	Crankshaft	Con-Rod Kit	Con-Rod Assembly	Crank Bearing	Crank Seal Kit	Bottom End Kit
TC 250 TE 250 249cc 66.4mm Liquid Cooled 2.614"	2014-16	AC	FL-5748	5748K	66.40	Std.	6343A	856M06640	8169DA	VT23630A		T.E. Bearing 01298	Top End C3222	Top End 35-0333	(14-15, TC) HR4026	Pro-X 04923	39-4923	Left NJ207R Right 6232X2	096320	Hot Rods (14-15, TC) CBK0006
CYLINDER SLEEVING REQUIRED FOR OVERSIZES																				
TC 250 TE 250 249cc 66.4mm Liquid Cooled 2.614"	2017-18	AC	FL-5785	5785K	66.40	Std.	6343A	856M06640	8169DA	VT23630A		T.E. Bearing 01298	Top End C3623	Top End 35-0976	(TE) HR00125	Pro-X 04923	39-4923	Left NJ207R Right 6232X2	096320	Hot Rods (TE) CBK00178
CYLINDER SLEEVING REQUIRED FOR OVERSIZES																				
TC 250 TE 250i 249cc 66.4mm Liquid Cooled 2.614"	2019-23	AC	FL-5811	5811K	66.40	Std.	6343A	856M06640	8169DA	VT23630A		T.E. Bearing 01298	Top End (19-22, TC) C3623	Top End (19-21, TC) (20-22, TE) 35-0976	(TE) HR00125	Pro-X 04923	39-4923	Left NJ207R Right 6232X2	096320	Hot Rods (20-21, TE) CBK00178
CYLINDER SLEEVING REQUIRED FOR OVERSIZES																				
WR-300 297cc 72mm Liquid Cooled 2.834"	2009-13	AC	FL-5774		72.00	Std.			8250DA	VT23457B		T.E. Bearing 01298				Pro-X 04926				
CYLINDER SLEEVING REQUIRED FOR OVERSIZES																				
TE 300 297cc 72mm Liquid Cooled 2.834"	2014-16	AC	FL-5749		72.00	Std.	01.6394A	858M07200	8250DA	VT23375A		T.E. Bearing 01298		Top End 35-0335	(14) HR4028	Pro-X 04923	39-4923	Left NJ207R Right 6232X2	096320	Hot Rods (14) CBK0011
CYLINDER SLEEVING REQUIRED FOR OVERSIZES																				
TE 300 TX 300 297cc 72mm Liquid Cooled 2.834"	2017-18	AC	FL-5798	5798K	72.00	Std.	01.6387A	882M07200	8301DA	VT23375A		T.E. Bearing 01298	Top End C3623	Top End 35-0976	HR00125	Pro-X 04923	39-4923	Left NJ207R Right 6232X2	096320	Hot Rods CBK00178
CYLINDER SLEEVING REQUIRED FOR OVERSIZES																				
TE 300i TX 300 TX 300i 297cc 72mm Liquid Cooled 2.834"	2020-23	AC	FL-5815	5815K	72.00	Std.	01.6388A	883M07200	8304DA	VT24244A		T.E. Bearing 01298	Top End C3623	Top End 35-0976	HR00125	Pro-X 04923	39-4923	Left NJ207R Right 6232X2	096320	Hot Rods (Thru 2021) CBK00178
CYLINDER SLEEVING REQUIRED FOR OVERSIZES																				
TE 300i TX 300i 297cc 72mm Liquid Cooled 2.834"	2024	AC	FL-5860		72.00	Std.	01.6388A	883M07200	8304DA	VT24244A		T.E. Bearing 01298		Top End 35-6072	HR00125	Pro-X 04923	39-4923	Left NJ207R Right 6232X2	096320	
CYLINDER SLEEVING REQUIRED FOR OVERSIZES																				

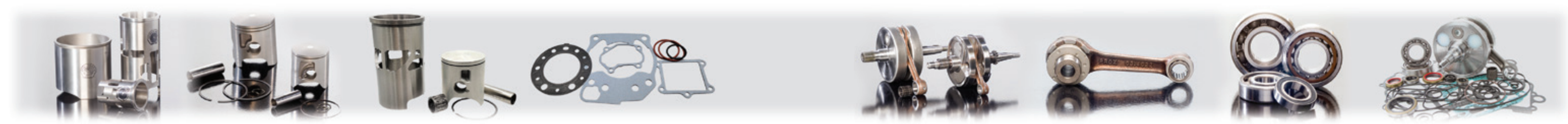

GASGAS
 HONDA
 HUSQVARNA
 KAWASAKI
 KTM
 SUZUKI
 YAMAHA
 DIRT BIKE SLEEVES
 STREET BIKE SLEEVES
 ACCESSORIES
 TECHNICAL



MODEL
Engine Description
Cylinder I.D. (mm/in.)



SLEEVE

REBUILD KIT
Sleeve • Piston
Gasket • T.E. Bearing

BORE SIZE (mm)

PISTON SIZE

TOP END

TOP END

VALVE TRAIN

BOTTOM END

PRO-X PISTON

WISECO PISTON

WOSSNER PISTON

VERTEX PISTON

JE PISTON

COMETIC GASKET

L.A. SLEEVE GASKET

CYLINDER AFTERMARKET KITS

VALVE / SPRING KIT

VALVE GUIDE

CAMSHAFT

CAM CHAIN

CRANKSHAFT

CON-ROD KIT

CRANK BEARING

ENGINE OIL SEAL KIT

BOTTOM END KIT
Crankshaft • Bearings • Seals • Gasket Set

HUSQVARNA FOUR-STROKE

MODEL	Year	AC	FL	BORE	STROKE	PRO-X PISTON	WISECO PISTON	WOSSNER PISTON	VERTEX PISTON	JE PISTON	COMETIC GASKET	L.A. SLEEVE GASKET	CYLINDER AFTERMARKET KITS	VALVE / SPRING KIT	VALVE GUIDE	CAMSHAFT	CAM CHAIN	CRANKSHAFT	CON-ROD KIT	CRANK BEARING	ENGINE OIL SEAL KIT	BOTTOM END KIT	
TC, TE-250 249cc 76mm	2002-05 Liquid Cooled 2.992"	AC	FL-5546	76.00	Std.			12.9:1 Comp. 8576DA 8576DB															
TE-250 249cc 76mm	2006-09 Liquid Cooled 2.992"	AC	FL-5546	76.00	Std.	12.9:1 Comp. 6336A 6336B		13:1 Comp. 8650DA 8650DB											Pro-X 03.6336				
TE-250 249cc 79mm	2010-12 Liquid Cooled 3.110"	AC	FL-5862	79.00	Std.	13.6:1 Comp. 6340A 6340B		14:1 Comp. 8770DA 8770DB	13.6:1 Comp. VT23599B			Top End C3805-EST								Pro-X 03.6340			
TE-250 249cc 79mm	2012-13 Liquid Cooled 3.110"	AC	FL-5862	79.00	Std.	13.6:1 Comp. 6341A 6341B		14:1 Comp. 8882DA 8882DB	13.5:1 Comp. VT23756B											Pro-X 03.6340			
FC-250 249cc 78mm	2014-22 Liquid-Cooled 3.070"	AC	FL-5743	78.00	Std.	(14-15) 13.9:1 Comp. 6333A 6333B	(14-15) 13.9:1 Comp. 40074M07800	(14-15) 13.9:1 Comp. 8865DA 8865DB	(14-15) 13.9:1 Comp. VT23757A VT23757B	(14-15) 13.5:1 Comp. 323895	Top End (15-19) C3595-EST	Top End (14-15) 35-0364	Cylinder Works 50006 (16-22) (Std. 78mm)	Pro-X Titanium Exhaust (14-21) 28-63331		Hot Cams (16-22) Intake 3306-1IN (Stage 1)	(14-15) CC-6351	Hot Rods (14-15) HR4402	(14-15) Pro-X 03.6333	NJ206ECP3	49-822364 (14-15)		
				78.00	Std.	(16-22) 14.4:1 Comp. 6346A 6346B	(16-22) 14.4:1 Comp. 40144M07800	(16-22) 14.4:1 Comp. 8923DA 8923DB	(16-22) 14.4:1 Comp. VT24097A VT24097B	(16-22) 14.5:1 Comp. 366506		(16-22) 35-0372	Cylinder Works Complete Kit 50006-K01 (Std. 78mm) (16-22)	Titanium Intake 28-63332		3308-2IN (Stage 2)	(16-22) CC-6356		Hot Rods HR8701		49-822372 (16-22)		
				78.00	Std.							Complete w/oil seals (14-15) 37-1364				Exhaust 3307-E (Stage 1 & 2)			Pro-X 03.6337				
FC-250 249cc 81mm	2023-24 Liquid-Cooled 3.188"	AC	FL-5854	81.00	Std.	14.5:1 Comp. 6348A 6348B		14.4:1 Comp. 4077DA 4077DB				Top End C3809											
FE-250 249cc 78mm	2014-23 Liquid-Cooled 3.070"	AC	FL-5743	78.00	Std.	13.9:1 Comp. 6333A 6333B	13.9:1 Comp. 40074M07800	14.25:1 Comp. 8979DA 8979DA	12.8:1 Comp. VT24196A VT24196B (17-23)	13.5:1 Comp. 323985 (14-16)		Top End (14-16) 35-0364	Cylinder Works 50004 (14-15) (Std. 78mm)	Pro-X Titanium Exhaust 28-63331			(14-16) CC-6351		(14-16) Pro-X 03.6333	NJ206ECP3	49-822364 (14-16)		
				78.00	Std.							(17-23) 35-0372	Cylinder Works Complete Kit 50004-K01 (Std. 78mm) (14-15)	Titanium Intake 28-63332			(17-23) CC-6356		Hot Rods HR8701		49-822372 (17-20)		
				78.00	Std.														Pro-X 03.6337				
FE-250 249cc 81mm	2024 Liquid-Cooled 3.188"	AC	FL-5854	81.00	Std.	14.5:1 Comp. 6348A 6348B		14.4:1 Comp. 4077DA 4077DB				Top End C3809											

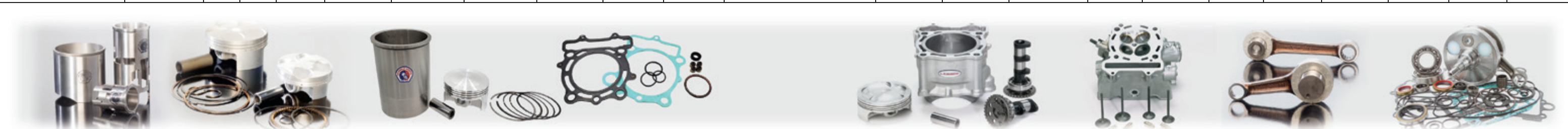

GASGAS
HONDA
HUSQVARNA
KAWASAKI
KTM
SUZUKI
YAMAHA
DIRT BIKE SLEEVES
STREET BIKE SLEEVES
ACCESSORIES
TECHNICAL



MODEL
Engine Description
Cylinder I.D. (mm/in.)



SLEEVE

REBUILD KIT
Sleeve • Piston
Gasket • T.E. Bearing

BORE SIZE
(mm)

PISTON SIZE

TOP END

TOP END

VALVE TRAIN

BOTTOM END

PRO-X PISTON

WISECO PISTON

WOSSNER PISTON

VERTEX PISTON

JE PISTON

COMETIC GASKET

L.A. SLEEVE GASKET

CYLINDER AFTERMARKET KITS

VALVE / SPRING KIT

VALVE GUIDE

CAMSHAFT

CAM CHAIN

CRANKSHAFT

CON-ROD KIT

CRANK BEARING

ENGINE OIL SEAL KIT

BOTTOM END KIT
Crankshaft • Bearings • Seals • Gasket Set

HUSQVARNA FOUR-STROKE (CONTINUED)

MODEL	Year	AC	FL	BORE	STROKE	PRO-X PISTON	WISECO PISTON	WOSSNER PISTON	VERTEX PISTON	JE PISTON	COMETIC GASKET	L.A. SLEEVE GASKET	CYLINDER AFTERMARKET KITS	VALVE / SPRING KIT	VALVE GUIDE	CAMSHAFT	CAM CHAIN	CRANKSHAFT	CON-ROD KIT	CRANK BEARING	ENGINE OIL SEAL KIT	BOTTOM END KIT		
FC-350 FX-350 350cc Liquid-Cooled 88mm CYL. WORKS COMPLETE KIT INCLUDES CYLINDER, PISTON, TOP END GASKETS	2014-23	AC	FL-5745	88.00	Std.	(14-15) 13.5:1 Comp. 6353A 6353B	(14-15) 14.5:1 Comp. 40015M08800	(14-22) 13.5:1 Comp. 8807DA 8807DB	(14-15) 13.5:1 Comp. VT23831A VT23831B	(14-15) 13.6:1 Comp. 300267	Top End C3805-EST (FC 15-19)	Top End 35-0373 (FC 16-18) (FX 17-19)	Cylinder Works 50007 (16-18)	Pro-X (14-22) Titanium Exhaust 28-63511				(14-15) CC-6351	(14-15) Pro-X 03.6363			49-822372		
	2017-22			88.00	Std.	(16-21) 14:1 Comp. 6353A 6353B	(16-21) 14.1:1 Comp. 40264M08800	(14-22) 14.5:1 Comp. 8810DA 8810DB	(16-22) 14:1 Comp. VT24098A VT24098B	(16-22) 14.5:1 Comp. 327145	35-0035 (FC 19-22) (FX 20-22)	50008 (19-22) (Std. 88mm)	Titanium Intake 28-63512	(23) CC-6363	(16-22) CC-6356	Hot Rods HR8702								
FE-350 350cc Liquid-Cooled 88mm CYL. WORKS COMPLETE KIT INCLUDES CYLINDER, PISTON, TOP END GASKETS	2014-23	AC	FL-5745	88.00	Std.	(14-16) 12.3:1 Comp. 6362A 6362B	(14-16) 12.3:1 Comp. 40056M08800		(14-16) 12.3:1 Comp. VT23711A VT23711B			Top End (14-16) 35-0339	Cylinder Works 50007 (17-19)	Pro-X (14-19) Titanium Exhaust 28-63511				(14-16) CC-6351	(14-16) Pro-X 03.6363			49-822364 (14-16)		
				88.00	Std.	(17-19) 6367A 6367B	(17-19) 40166M08800	(17-19) 8941DA 8941DB	(17-19) VT24213A VT24213B	(17-19) 36-0373	50008 (20-23) (Std. 88mm)	Titanium Intake 28-63512	(17-23) CC-6356	Hot Rods HR8710									49-822372 (17-22)	
				88.00	Std.	(20-23) 13.5:1 Comp. 6353A 6353B	(20-23) 14:1 Comp. 40264M08800	(20-23) 13.5:1 Comp. 8990DA 8990DB	(20-23) 14:1 Comp. VT24098A VT24098B	(20-22) 35-0035	Complete w/oil seals (14-16) 37-1368	Cylinder Works Complete Kit 50007-K01 (17-19)	Steel Exhaust 28-63621		Wossner WR4069									
TC, TE-410 WXC, WXE-410 400cc Liquid-Cooled 91.50mm	1998-01	AC	FL-5325	91.50	Std.	11.4:1 Comp. 6409A 6409B		11.4:1 Comp. 8514DA 8514DB				Top End C7730 (98-01)												
	1995-97			91.51	Std.																			
TC, TE-450	2002-05	AC	FL-5547	97.00	Std.																			
TC, TE-450	2006-10	AC	FL-5547	97.00	Std.	(TC) 12.9:1 Comp. 6348A 6348B		(TC) 13:1 Comp. 8651DA 8651DB						Pro-X Titanium Exhaust 28-64251								Pro-X 03.6425		
				97.00	Std.	(TE) 12.9:1 Comp. 6346A 6346B										Titanium Intake 28-64252							Wossner WR4015	

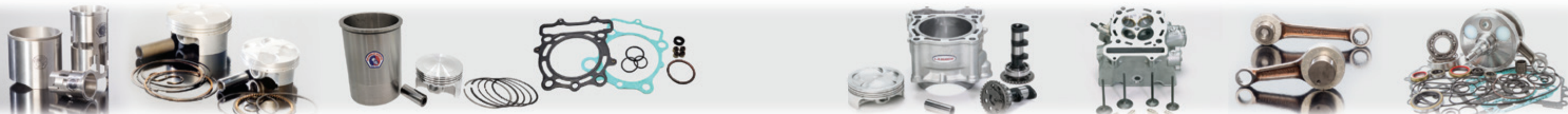

GASGAS
HONDA
HUSQVARNA
KAWASAKI
KTM
SUZUKI
YAMAHA
DIRT BIKE SLEEVES
STREET BIKE SLEEVES
ACCESSORIES
TECHNICAL



MODEL
Engine Description
Cylinder I.D. (mm/in.)

SLEEVE

REBUILD KIT
Sleeve • Piston
Gasket • T.E. Bearing

BORE SIZE (mm)

PISTON SIZE

TOP END

TOP END

VALVE TRAIN

BOTTOM END

PRO-X PISTON

WISECO PISTON

WOSSNER PISTON

VERTEX PISTON

JE PISTON

COMETIC GASKET

L.A. SLEEVE GASKET

CYLINDER AFTERMARKET KITS

VALVE / SPRING KIT

VALVE GUIDE

CAMSHAFT

CAM CHAIN

CRANKSHAFT

CON-ROD KIT

CRANK BEARING

ENGINE OIL SEAL KIT

BOTTOM END KIT
Crankshaft • Bearings • Seals • Gasket Set

HUSQVARNA FOUR-STROKE (CONTINUED)

MODEL	Year	AC	FL	SLEEVE	REBUILD KIT	BORE SIZE (mm)	PISTON SIZE	PRO-X PISTON	WISECO PISTON	WOSSNER PISTON	VERTEX PISTON	JE PISTON	COMETIC GASKET	L.A. SLEEVE GASKET	CYLINDER AFTERMARKET KITS	VALVE / SPRING KIT	VALVE GUIDE	CAMSHAFT	CAM CHAIN	CRANKSHAFT	CON-ROD KIT	CRANK BEARING	ENGINE OIL SEAL KIT	BOTTOM END KIT	
FC-450 FS-450 FX-450 449cc 95mm Liquid-Cooled 3.740"	2014-24	AC	FL-5744	95.00 95.01	Std. Std.	6433A 6433B	12.6:1 Comp.	12.75:1 Comp.	12.6:1 Comp.	12.6:1 Comp.		Top End (16-23) C3604-EST		Top End 35-6433 (FC 14-15) 35-0374 (16-23)	Cylinder Works (16-22) 50009 (Std. 95mm) Cylinder Works Complete Kit (16-22) 50009-K01 (Std. 95mm)	Pro-X (14-18) FC, FX Titanium Exhaust 28-64331 Titanium Intake 28-64332 (19-23) FC, FS, FX Titanium Exhaust 28-64191 Titanium Intake 28-64192				(14-15) CC-6428 (16-18) CC-6328 (19-22) CC-1335 (23-24) CC-6443	Pro-X (14-15) 03.6433 (16-24) 03.6436 Wossner (14-15) WR4058 (16-24) WR4068	SX07E39 (14-15 2x) 49-822374 (16-22) NJ207ECP-1 (16-23 2x) Bearing / Seal Kit 49K090 (14-15, FC) Bearing / Seal Kit 49K093 (16-22)			
FE-450 449cc 95mm Liquid-Cooled 3.740"	2014-23	AC	FL-5744	95.00 95.01	Std. Std.	6432A 6432B	(14-19) 11.9:1 Comp.	(14-19) 11.9:1 Comp.	(14-19) 12.6:1 Comp.	(14-16) 11.8:1 Comp.		Top End (17-23) C3604-EST		Top End (14-16) 35-0342 (17-23) 35-0991 Complete w/oil seals (14-16) 37-1959 (17-21) 37-1998	Cylinder Works (17-21) 50009 (Std. 95mm) Cylinder Works Complete Kit (17-21) 50009-K02 (Std. 95mm)	(14-19) Steel Exhaust 28-64281 Titanium Intake 28-64332 (20-23) Steel Exhaust 28-64201 Titanium Intake 28-64192			(14-16) CC-6428 (17-19) CC-6328 (20-23) CC-1335	Pro-X (14-16) 03.6433 (17-23) 03.6436 Wossner (14-16) WR4058 (17-23) WR4068	SX07E39 (14-16 2x) 49-822374 (17-21) NJ207ECP-1 (17-23 2x) Bearing / Seal Kit 49K093 (17-23) 49K090 (14-16)				
FE-501 510cc 95mm Liquid-Cooled 3.740"	2014-23	AC	FL-5772	95.00 95.01	Std. Std.	6512A 6512B	(14-19) 11.8:1 Comp.	(14-19) 11.8:1 Comp.	(14-19) 11.8:1 Comp.	(14-23) 11.8:1 Comp.	(14-19) 11.8:1 Comp.			Top End (14-16) 35-0342 (17-23) 35-0991 Complete w/oil seals (14-16) 37-1959 (17-19) 37-1998	Cylinder Works 50010 (Std. 95mm) Cylinder Works Complete Kit (17-22) 50010-K01 (Std. 95mm)	(14-19) Steel Exhaust 28-64281 Titanium Intake 28-64332 (20-23) Steel Exhaust 28-64201 Titanium Intake 28-64192			(14-16) CC-6508 (17-19) CC-1403 (20-23) CC-6328	Wossner (14-16) WR4066 (17-23) WR4079-R	SX07E39 (14-16 2x) 49-822360 (14-16) NJ207ECP-1 (17-23 2x) 49-822374 (17-22) Bearing / Seal Kit 49K093 (17-23) 49K090 (14-16)				
TC, TXC-510 501cc 97mm Liquid Cooled 3.819"	2004-10	AC	FL-5548	97.00	Std.	6516A	(06-10) 12.9:1 Comp.		(06-10) 13:1 Comp.													Pro-X 03.6505 (06-10)			
TE-510 501cc 97mm Liquid Cooled 3.819"	2008-10	AC	FL-5548	97.00	Std.	6518A	12.9:1 Comp.																Pro-X 03.6505		

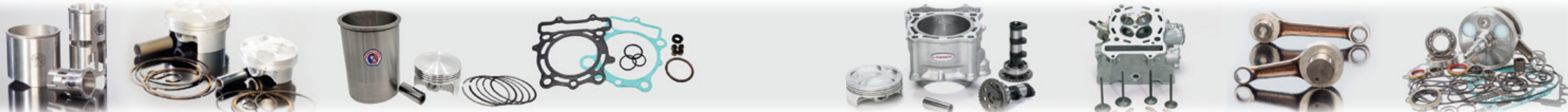

GASGAS
 HONDA
 HUSQVARNA
 KAWASAKI
 KTM
 SUZUKI
 YAMAHA
 DIRT BIKE SLEEVES
 STREET BIKE SLEEVES
 ACCESSORIES
 TECHNICAL



MODEL
Engine Description
Cylinder I.D. (mm/in.)



SLEEVE

REBUILD KIT
Sleeve • Piston
Gasket • T.E. Bearing

BORE SIZE (mm)

PISTON SIZE

TOP END

TOP END

VALVE TRAIN

BOTTOM END

PRO-X PISTON

WISECO PISTON

WOSSNER PISTON

VERTEX PISTON

JE PISTON

COMETIC GASKET

L.A. SLEEVE GASKET

CYLINDER AFTERMARKET KITS

VALVE / SPRING KIT

VALVE GUIDE

CAMSHAFT

CAM CHAIN

CRANKSHAFT

CON-ROD KIT

CRANK BEARING

ENGINE OIL SEAL KIT

BOTTOM END KIT
Crankshaft • Bearings • Seals • Gasket Set

HUSQVARNA FOUR-STROKE (CONTINUED)

MODEL	Engine Description	Cylinder I.D. (mm/in.)	SLEEVE	REBUILD KIT	BORE SIZE (mm)	PISTON SIZE	PRO-X PISTON	WISECO PISTON	WOSSNER PISTON	VERTEX PISTON	JE PISTON	COMETIC GASKET	L.A. SLEEVE GASKET	CYLINDER AFTERMARKET KITS	VALVE / SPRING KIT	VALVE GUIDE	CAMSHAFT	CAM CHAIN	CRANKSHAFT	CON-ROD KIT	CRANK BEARING	ENGINE OIL SEAL KIT	BOTTOM END KIT	
WMX, WXE-610 1991-95 577cc Liquid Cooled 98mm 3.858"	RS	FL-5078			98.00	Std.																		
WMX, WXE-610 1996-97 TC, TE-610 1998-04 577cc Liquid Cooled 98mm 3.858"	AC	FL-5314			98.00 100.00	Std. .080			(99-03) 10:1 Comp. 8526DA 8526D200			Top End C7732 (99-04)								Wossner WR4042				
TE-610 2005-10 577cc Liquid Cooled 98mm 3.858"	AC	FL-5314			98.00 100.00	Std. .080			12.9:1 Comp. 8913DA 8913D200			Top End C7732 (05-08)												
701 Enduro 2016-20 701cc Single Liquid-Cooled 105mm 4.134"	AC	FL-5808																						

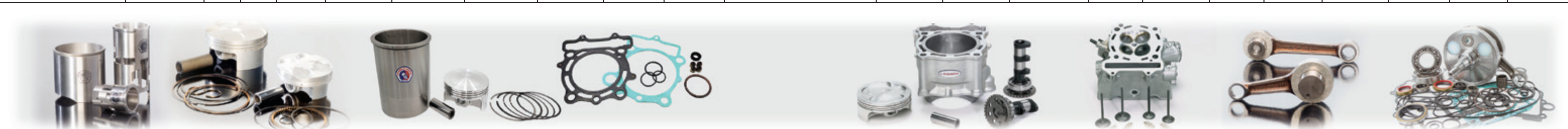

GASGAS
HONDA
HUSQVARNA
KAWASAKI
KTM
SUZUKI
YAMAHA
DIRT BIKE SLEEVES
STREET BIKE SLEEVES
ACCESSORIES
TECHNICAL



MODEL
Engine Description
Cylinder I.D. (mm/in.)

SLEEVE

REBUILD KIT
Sleeve - Piston
Gasket - T.E. Bearing

BORE SIZE (mm)

PISTON SIZE

TOP END

TOP END

BOTTOM END

PRO-X PISTON

WISECO PISTON

WOSSNER PISTON

VERTEX PISTON

T.E. BEARING

COMETIC GASKET

L.A. SLEEVE GASKET

CRANKSHAFT

CON-ROD KIT

CON-ROD ASSEMBLY
Rod - Bearings - Seals

CRANK BEARING

CRANK SEAL KIT

BOTTOM END KIT
Crankshaft - Bearings - Seals - Gasket Set

KAWASAKI TWO-STROKE

KDX-50 49cc 41mm	2003-06 1.614"	CC	FL-5492	41.00 41.50 42.00 43.00	Std. .020 .040 .080	01.3001 01.3001.50 01.3001.100	826M04100 826M04150 826M04200 826M04300					T.E. Bearing 01216	Top End C7014								
KX-60 60cc 43mm	1985-03 Liquid Cooled 1.693"	AC	KA-935	935K (94-98) 935K-1 (99-03)	43.00 43.01 43.25 43.50 44.00 45.00	Std. Std. .010 .020 .040 .080	4290A 4290B 4291 4293 4304	648M04300 648M04350 648M04400 648M04500				T.E. Bearing 01215	Top End C7154 (94-98) C7501 (99-03)	Top End 35-4100 Complete with Oil Seals 37-4100	HR4015	Pro-X 04982	39-4982	6304C3 Bearing / Seal Kit 494481	094481	Hot Rods CBK0049	
KX-65 (NO. 1931) 64.7cc 44.5mm	2000-01 Liquid Cooled 1.752"	AC	KA-5431	5431K	44.50 45.00 46.50	Std. .020 .080	4309A	752M04450 752M04500 752M04650	8196DA			T.E. Bearing 01215	Top End C7736 (45mm) C7682 (47mm)	Top End 35-4021 Complete with Oil Seals 37-4021	HR4014	Pro-X 04982	39-4982	6304C3 Bearing / Seal Kit 494481	094481	Hot Rods CBK0048	
KX-65 (NO. 1973) 64.7cc 44.5mm	2002-24 Liquid Cooled 1.752"	AC	KA-5472	5472K	44.50 45.00 46.50	Std. .020 .080	4309A	752M04450 752M04500 752M04650	8196DA			T.E. Bearing 01215	Top End C7736 (45mm) C7682 (47mm)	Top End 35-4021 Complete with Oil Seals 37-4021 (02-05) 37-1417 (06-22)	HR4014 (2002-05) HR4065 (2006-21)	Pro-X 04982	39-4982	6304C3 Bearing / Seal Kit 494481	094481	Hot Rods CBK0048 (02-05) CBK0100 (06-21)	
KX-80 82cc 48mm	1978-79 1.890"	AC	FL-672		48.00 49.00	Std. .040		446M04800 446M04900				T.E. Bearing 01303							6304C3		
KX-80 82cc 48mm	1980-81 1.890"	AC	KA-735		48.00 49.00	Std. .040		446M04800 446M04900				T.E. Bearing 01303							6205C3 (80) 6304C3 (81) Bearing / Seal Kit 494482 (80) 494480 (81)	094482 (80) 094480 (81)	
KX-80 82cc 48mm	1982 1.890"	AC	KA-736		48.00 49.00	Std. .040		446M04800 446M04900				T.E. Bearing 01303				Pro-X 04973	39-4480	6304C3 Bearing / Seal Kit 494480	094480		
KX-80 82cc 48mm	1983 Liquid Cooled 1.890"	AC	KA-791		48.00 49.00	Std. .040		446M04800 446M04900				T.E. Bearing 01303	Top End C7027	Complete with Oil Seals 37-4402		Pro-X 04973	39-4480	6304C3 Bearing / Seal Kit 494480	094480		



GASGAS
HONDA
HUSQVARNA
KAWASAKI
KTM
SUZUKI
YAMAHA
DIRT BIKE SLEEVES
STREET BIKE SLEEVES
ACCESSORIES
TECHNICAL



MODEL
Engine Description
Cylinder I.D. (mm/in.)

SLEEVE

REBUILD KIT
Sleeve - Piston
Gasket - T.E. Bearing

BORE SIZE (mm)

PISTON SIZE

TOP END

TOP END

BOTTOM END

PRO-X PISTON

WISECO PISTON

WOSSNER PISTON

VERTEX PISTON

T.E. BEARING

COMETIC GASKET

L.A. SLEEVE GASKET

CRANKSHAFT

CON-ROD KIT

CON-ROD ASSEMBLY
Rod - Bearings - Seals

CRANK BEARING

CRANK SEAL KIT

BOTTOM END KIT
Crankshaft - Bearings - Seals - Gasket Set

KAWASAKI TWO-STROKE (CONTINUED)

KX-80 82cc 48mm Liquid Cooled 1.890"	1984	AC	KA-852	48.00 48.50 49.00	Std. .020 .040		514M04800 514M04850 514M04900	8201DA 8201D050 8201D100			T.E. Bearing 01303	Top End C7027	Complete with Oil Seals 37-4402		Pro-X 04973	39-4480	6304C3 Bearing / Seal Kit 494480	094480	
KX-80 82cc 48mm Liquid Cooled 1.890"	1985	AC	KA-854	48.00 48.50 49.00	Std. .020 .040		514M04800 514M04850 514M04900	8201DA 8201D050 8201D100			T.E. Bearing 01303	Top End C7028	Complete with Oil Seals 37-4402		Pro-X 04973	39-4973	6304C3 Bearing / Seal Kit 494481	094481	
KX-80 82cc 48mm Liquid Cooled 1.890"	1986-87	AC	KA-967	48.00 48.01 49.00	Std. Std. .040	4230C 4230D	539M04800 539M04900				T.E. Bearing 01303	Top End C7029	Complete with Oil Seals 37-1403		Pro-X 04973	39-4973	6304C3 Bearing / Seal Kit 494481	094481	
KX-80 Big Bore to 100cc 100cc Liquid Cooled	1986-87	AC	KA-968	52.00 52.50	Std. .020			8197D400 8197D450			T.E. Bearing 01303	Top End C7318			Pro-X 04973	39-4973	6304C3 Bearing / Seal Kit 494481	094481	
KX-80 L1, N1 82cc 48mm Liquid Cooled 1.890"	1988-90	AC	KA-5041	48.00 48.01 48.50 49.00 50.00	Std. Std. .020 .040 .080	4230C 4230D	644M04800 644M04850 644M04900 644M05000	8197DA 8197D050 8197D100			T.E. Bearing 01303	Top End C7030	Top End 35-0404 (88-89) 35-0406 (90) Complete with Oil Seals 37-1404 (88-89) 37-1406 (90)		Pro-X 04973	39-4973	6304C3 Bearing / Seal Kit 494481	094481	
KX-80 Big Bore to 100cc 100cc 52mm Liquid Cooled 2.047"	1988-90	AC	KA-5042	52.00 52.50	Std. .020			8197D400 8197D450			T.E. Bearing 01303	Top End GS5042			Pro-X 04973	39-4973	6304C3 Bearing / Seal Kit 494481	094481	
KX-80 82cc 48mm Liquid Cooled 1.890"	1991-94	AC	KA-5121	5121K 48.00 48.01 48.50 49.00 50.00	Std. Std. .020 .040 .080	4280A 4280B	644M04800 644M04850 644M04900 644M05000	8197DA 8197D050 8197D100	VT22502B		T.E. Bearing 01303	Top End C7031 (49mm) C7307 (50mm)	Top End 35-4111 Complete with Oil Seals 37-4111	HR4016	Pro-X 04973	39-4973	6304C3 Bearing / Seal Kit 494481	094481	Hot Rods CBK0050
KX-80 82cc 48mm Liquid Cooled 1.890"	1995-97	AC	KA-5316	5316K 48.00 48.01 48.50 49.00 50.00	Std. Std. .020 .040 .080	4280A 4280B	644M04800 644M04850 644M04900 644M05000	8197DA 8197D050 8197D100	VT22502B		T.E. Bearing 01303	Top End C7031 (49mm) C7307 (50mm)	Top End 35-4111 Complete with Oil Seals 37-4111	HR4016	Pro-X 04973	39-4973	6304C3 Bearing / Seal Kit 494481	094481	Hot Rods CBK0050
KX-80 Big Bore to 100cc 100cc 52mm Liquid Cooled 2.047"	1991-97	AC	KA-5263	52.00 52.50	Std. .020			8197D400 8197D450			T.E. Bearing 01303	Top End GS5144		HR4016	Pro-X 04973	39-4973	6304C3 Bearing / Seal Kit 494481	094481	



GASGAS
HONDA
HUSQVARNA
KAWASAKI
KTM
SUZUKI
YAMAHA
DIRT BIKE SLEEVES
STREET BIKE SLEEVES
ACCESSORIES
TECHNICAL



MODEL
Engine Description
Cylinder I.D. (mm/in.)



SLEEVE

REBUILD KIT
Sleeve - Piston
Gasket - T.E. Bearing

BORE SIZE (mm)

PISTON SIZE

TOP END

TOP END

BOTTOM END

PRO-X PISTON

WISECO PISTON

WOSSNER PISTON

VERTEX PISTON

T.E. BEARING

COMETIC GASKET

L.A. SLEEVE GASKET

CRANKSHAFT

CON-ROD KIT

CON-ROD ASSEMBLY
Rod - Bearings - Seals

CRANK BEARING

CRANK SEAL KIT

BOTTOM END KIT
Crankshaft - Bearings - Seals - Gasket Set

KAWASAKI TWO-STROKE (CONTINUED)

MODEL	Year	AC	Part No.	5351K	48.00	Std.	4280A	644M04800	8197DA	VT22502B	T.E. Bearing	Top End	Top End	HR4016	Pro-X	39-4941	6304C3	094481	Hot Rods
KX-80 82cc Liquid Cooled 48mm 1.890"	1998-00	AC	KA-5351	5351K	48.00 48.01 48.50 49.00 50.00	Std. Std. .020 .040 .080	4280A 4280B	644M04800 644M04850 644M04900 644M05000	8197DA 8197D050 8197D100	VT22502B	T.E. Bearing 01303	Top End C7391 (49mm)	Top End 35-4118 Complete with Oil Seals 37-4118	HR4016	Pro-X 04941 Hot Rods HR8147	39-4941	6304C3 Bearing / Seal Kit 494481	094481	Hot Rods CBK0002
KX-80 Big Bore to 100cc 100cc Liquid Cooled 52mm 2.047"	1998-00	AC	KA-5351B		52.00 52.50 53.00 54.50	Std. .020 .040 .080		651M05250 651M05300 651M05450	8197D400 8197D450		T.E. Bearing 01303	Top End GS5351		HR4016	Pro-X 04941 Hot Rods HR8147	39-4973	6304C3 Bearing / Seal Kit 494481	094481	
KX-85 84cc Liquid Cooled 48.5mm 1.910"	2001-13	AC	KA-5449	5449K	48.50 48.51 49.00 49.50 50.50	Std. Std. .020 .040 .080	4281A 4281B	782M04850 782M04900 782M04950 782M05050	8102DA 8102DB	VT22803A VT22803B	T.E. Bearing 01303	Top End C3501 C7859 (50.5mm)	Top End 35-4121 Complete with Oil Seals 37-4121 (01-06) 37-1419 (07-13)	HR4016 (2001-05) HR4066 (2006-13)	Pro-X 04941 Hot Rods HR8147	39-4941	6304C3 Bearing / Seal Kit 494481	094481	Hot Rods CBK0053 (01-05) CBK0101 (06) CBK0029 (07-13)
KX-85 Big Bore to 100cc 52mm 2.047"	2001-13	AC	KA-5351B		52.00 52.50 53.00 54.50	Std. .020 .040 .080		651M05250 651M05300 651M05450	8102D350 8102D400 8102D450		T.E. Bearing 01303	Top End GS5351		HR4016 (2001-05) HR4066 (2006-13)	Pro-X 04941 Hot Rods HR8147	39-4941	6304C3 Bearing / Seal Kit 494481	094481	
KX-85 84cc Liquid Cooled 48.5mm 1.910"	2014-24	AC	KA-5778	5778K	48.50 48.51 49.00 49.50 50.50 52.00 52.50	Std. Std. .020 .040 .080 .140 .140	4282A 4282B	879M04850 879M04900 879M04950 879M05050	8102DA 8102DB	VT23637B	T.E. Bearing 01303	Top End C3541	Top End 35-0483 Complete with Oil Seals 37-1483	(14-23) HR4419	Pro-X 04941 Hot Rods HR8147	39-4941	6304C3 Bearing / Seal Kit 494481	094481	Hot Rods (14-20) CBK0207
KX-100 99cc Liquid Cooled 52.5mm 2.067"	1995-97	AC	KA-5263	5263K	52.50 53.00 54.50	Std. .020 .080	4283A	651M05250 651M05300 651M05450	8254DA 8254D050 8254D200	VT23614A VT23614050 VT23614200	T.E. Bearing 01303	Top End C7268 (53mm) C7347 (54.5mm)	Complete with Oil Seals 37-4409	HR4016	Pro-X 04973	39-4973	6304C3 Bearing / Seal Kit 494481	094481	Hot Rods CBK0051
KX-100 99cc Liquid Cooled 52.5mm 2.067"	1998-05	AC	KA-5358	5358K	52.50 53.00 53.50 54.00 54.50	Std. .020 .040 .060 .080	4283A	651M05250 651M05300 651M05450	8254DA 8254D050 8254D100 8254D150 8254D200	VT23614A VT23614050 VT23614200	T.E. Bearing 01303	Top End C7392 (53mm) C7413 (54.5mm)	Top End 35-0411 Complete with Oil Seals 37-1411	HR4016	Pro-X 04941	39-4941	6304C3 Bearing / Seal Kit 494481	094481	Hot Rods CBK0052
KX-100 99cc Liquid Cooled 52.5mm 2.067"	2006-13	AC	KA-5608	5608K	52.50 53.00 53.50 54.00 54.50	Std. .020 .040 .060 .080	4283A	651M05250 651M05300 651M05450	8254DA 8254D050 8254D100 8254D150 8254D200	VT23614A VT23614050 VT23614200	T.E. Bearing 01303	Top End C7392 (53mm) C7413 (54.5mm)	Top End 35-0411 Complete with Oil Seals 37-1418	HR4066	Pro-X 04941	39-4941	6304C3 Bearing / Seal Kit 494481	094481	Hot Rods CBK0102
KX-100 99cc Liquid Cooled 52.5mm 2.067"	2014-21	AC	KA-5779	5779K	52.50 52.51 53.00 53.50 54.00 54.50	Std. Std. .020 .040 .060 .080	4284A 4284B	880M05250 880M05300 880M05450	8254DA 8254D050 8254D100 8254D150 8254D200	VT23621A VT23621050 VT23621200	T.E. Bearing 01303	Top End C3542 (52.50mm) C3543 (54.50mm)	Top End 35-0484 Complete with Oil Seals 37-1484	HR4419	Pro-X 04941 Hot Rods HR8147	39-4941	6304C3 Bearing / Seal Kit 494481	094481	Hot Rods (14-16) CBK0203



GASGAS
HONDA
HUSAVARNA
KAWASAKI
KTM
SUZUKI
YAMAHA
DIRT BIKE SLEEVES
STREET BIKE SLEEVES
ACCESSORIES
TECHNICAL



MODEL
Engine Description
Cylinder I.D. (mm/in.)



SLEEVE

REBUILD KIT
Sleeve - Piston
Gasket - T.E. Bearing

BORE SIZE (mm)

PISTON SIZE

TOP END

TOP END

BOTTOM END

PRO-X PISTON

WISECO PISTON

WOSSNER PISTON

VERTEX PISTON

T.E. BEARING

COMETIC GASKET

L.A. SLEEVE GASKET

CRANKSHAFT

CON-ROD KIT

CON-ROD ASSEMBLY
Rod - Bearings - Seals

CRANK BEARING

CRANK SEAL KIT

BOTTOM END KIT
Crankshaft - Bearings - Seals - Gasket Set

KAWASAKI TWO-STROKE (CONTINUED)

KX-112 112cc 52.5mm Liquid Cooled 2.067"	2022-24	AC	KA-5855	5855K	52.50 52.51 53.00 54.50	Std. Std. .020 .080	4284A 4284B	880M05250 880M05300 880M05450	8322DA 8322DB				T.E. Bearing 01303	Top End C3542	Top End 35-0484 Complete with Oil Seals 37-1484	Wossner WR2078R		6304C3 Bearing / Seal Kit 494481	094481		
KDX-80 82cc 48mm 1.890"	1980-82	AC	KA-672		48.00 49.00	Std. .040		446M04800 446M04900					T.E. Bearing 01303				Pro-X 04973 (82)		094481 (82)		
KDX-80 82cc 48mm 1.890"	1983-88	AC	KA-736		48.00 49.00	Std. .040		514M04800 514M04900					T.E. Bearing 01303				Pro-X 04973	39-4480 (83-84) 39-4973 (85-88)	6304C3 Bearing / Seal Kit 494480 (83-84) 494481 (85-88)	094480 (83-84) 094481 (85-88)	
KX-125 A-6 124cc 56mm Single (Non Bridged Exhaust) 2.205"	1980	AC	KA-680		56.00	Std.			8202DA				T.E. Bearing 01310	Top End C7131			Hot Rods HR8102		6304C3 Bearing / Seal Kit 494482	094482	
KX-125 A-7 124cc 56mm Single 2.205"	1981	AC	KA-717		56.00	Std.			8202DA				T.E. Bearing 01310	Top End C7131			Hot Rods HR8102		6305C3 Bearing / Seal Kit 494485	094485	
KX-125 B-1 124cc 56mm Liquid Cooled 2.205"	1982	AC	KA-737		56.00 57.00	Std. .040		486M05600	8210DA 8210D100				T.E. Bearing 01310	Top End C7132			Hot Rods HR8102		Left 6305C3 Right 6304C3 Bearing / Seal Kit 496304	094480	
KX-125 124cc 56mm Liquid Cooled 2.205"	1983-84	AC	KA-792		56.00 57.00	Std. .040		486M05600	8210DA 8210D100				T.E. Bearing 01310	Top End C7109 (83) C7110 (84)			Hot Rods HR8102		Left 6305C3 Right 6304C3 Bearing / Seal Kit 496304	094480	
KX-125 KIPS 124cc 56mm Liquid Cooled 2.205"	1985	AC	KA-855		56.00 57.00	Std. .040		486M05600	8210DA 8210D100				T.E. Bearing 01310	Top End C7032			Hot Rods HR8102		Left 6305C3 Right 6304C3 Bearing / Seal Kit 496304	094480	



GASGAS
HONDA
HUSQVARNA
KAWASAKI
KTM
SUZUKI
YAMAHA
DIRT BIKE SLEEVES
STREET BIKE SLEEVES
ACCESSORIES
TECHNICAL



MODEL
Engine Description
Cylinder I.D. (mm/in.)



SLEEVE

REBUILD KIT
Sleeve - Piston
Gasket - T.E. Bearing

BORE SIZE (mm)

PISTON SIZE

TOP END

TOP END

BOTTOM END

PRO-X PISTON

WISECO PISTON

WOSSNER PISTON

VERTEX PISTON

T.E. BEARING

COMETIC GASKET

L.A. SLEEVE GASKET

CRANKSHAFT

CON-ROD KIT

CON-ROD ASSEMBLY
Rod - Bearings - Seals

CRANK BEARING

CRANK SEAL KIT

BOTTOM END KIT
Crankshaft - Bearings - Seals - Gasket Set

KAWASAKI TWO-STROKE (CONTINUED)

KX-125 KIPS (No. 1476) 1986 124cc Liquid Cooled 56mm 2.205"	AC	KA-945	945K	56.00 57.00	Std. .040		540M05600	8211DA 8211D100			T.E. Bearing 01310	Top End C7032			Hot Rods HR8102		Left 6305C3 Right 6322X	094483	
CYLINDER SLEEVING REQUIRED FOR OVERSIZES																	Bearing / Seal Kit 494483		
KX-125 KIPS (No. 1508) 1987 124cc Liquid Cooled 56mm 2.205"	AC	KA-5006	5006K	56.00 56.01	Std. Std.	4205C 4205D	555M05600				T.E. Bearing 01310	Top End C7119			Hot Rods HR8102		Left 6305C3 Right 6322X	094483	
CYLINDER SLEEVING REQUIRED FOR OVERSIZES																	Bearing / Seal Kit 494483		
KX-125 F-1 (No. 1539) 1988 124cc Liquid Cooled 56mm 2.205"	AC	KA-5043	5043K	56.00 56.01 57.00	Std. Std. .040	4208C 4208D	566M05600 566M05700				T.E. Bearing 01310	Top End C7033			Pro-X 04986 Hot Rods HR8129	39-4986	6322X	094484	
CYLINDER SLEEVING REQUIRED FOR OVERSIZES																	Bearing / Seal Kit 494484		
KX-125 G-1 (No. 1565) 1989 124cc Liquid Cooled 56mm 2.205"	AC	KA-5089	5089K	56.00 56.01 56.50	Std. Std. .020	4208C 4208D	578M05600 578M05650				T.E. Bearing 01310	Top End C7034			Pro-X 04986 Hot Rods HR8129	39-4986	6322X	094484	
CYLINDER SLEEVING REQUIRED FOR OVERSIZES																	Bearing / Seal Kit 494484		
KX-125 (No. 1602) 1990 124cc Liquid Cooled 56mm 2.205"	AC	KA-5107	5107K	56.00 56.01 56.50	Std. Std. .020	4208C 4208D	589M05600	8106DA 8106DB 8106D050			T.E. Bearing 01310	Top End C7035			Pro-X 04986 Hot Rods HR8129	39-4986	6322X	094484	
CYLINDER SLEEVING REQUIRED FOR OVERSIZES																	Bearing / Seal Kit 494484		
KX-125 (No. 1645) 1991 124cc Liquid Cooled 56mm 2.205"	AC	KA-5107	5107K-1	56.00 56.01 56.50 57.00	Std. Std. .020 .040	4209C 4209D	603M05600	8108DA 8108DB 8108D050 8108D100			T.E. Bearing 01310	Top End C7036			Pro-X 04986 Hot Rods HR8129	39-4986	6322X	094484	
CYLINDER SLEEVING REQUIRED FOR OVERSIZES																	Bearing / Seal Kit 494484		
KX-125 (No. 1672) 1992 124cc Liquid Cooled 54mm 2.126"	AC	KA-5154	5154K	54.00 54.01 54.50 55.00	Std. Std. .020 .040		616M05400	8110DA 8110DB 8110D050 8110D100			T.E. Bearing 01310	Top End C7117			Hot Rods HR8102		6322X	094484	
CYLINDER SLEEVING REQUIRED FOR OVERSIZES																	Bearing / Seal Kit 494484		
KX-125 (No. 1687) 1993 124cc Liquid Cooled 54mm 2.126"	AC	KA-5179	5179K	54.00 54.01 54.50 55.00	Std. Std. .020 .040		626M05400	8110DA 8110DB 8110D050 8110D100			T.E. Bearing 01310	Top End C7133			Hot Rods HR8102		6322X	094484	
CYLINDER SLEEVING REQUIRED FOR OVERSIZES																	Bearing / Seal Kit 494484		





MODEL
Engine Description
Cylinder I.D. (mm/in.)



SLEEVE

REBUILD KIT
Sleeve - Piston
Gasket - T.E. Bearing

BORE SIZE (mm)

PISTON SIZE

TOP END

TOP END

BOTTOM END

PRO-X PISTON

WISECO PISTON

WOSSNER PISTON

VERTEX PISTON

T.E. BEARING

COMETIC GASKET

L.A. SLEEVE GASKET

CRANKSHAFT

CON-ROD KIT

CON-ROD ASSEMBLY
Rod - Bearings - Seals

CRANK BEARING

CRANK SEAL KIT

BOTTOM END KIT
Crankshaft - Bearings - Seals - Gasket Set

KAWASAKI TWO-STROKE (CONTINUED)

KX-125 (No. 1720) 124cc Liquid Cooled 54mm 2.126"	1994	AC	KA-5208	5208K	54.00 54.01	Std. Std.	4294B 4294C	640M05400 640M05500	8111DA 8111DB 8111D100			T.E. Bearing 01318	Top End C7133			Pro-X 04970	39-4970	6322X 094484	Bearing / Seal Kit 494484	
<i>CYLINDER SLEEVING REQUIRED FOR OVERSIZES</i>																				
KX-125 (No. 1752) 124cc Liquid Cooled 54mm 2.126"	1995	AC	KA-5251	5251K	54.00 54.01 54.50 55.00 56.00	Std. Std. .020 .040 .060	4296A 4296B	652M05400 652M05450 652M05500 652M05600	8112DA 8112DB 8112D050 8112D100 8112D200			T.E. Bearing 01318	Top End C7241	Top End 35-4215 Complete with Oil Seals 37-4215		Pro-X 04970	39-4970	6322X 094484	Bearing / Seal Kit 494484	
<i>CYLINDER SLEEVING REQUIRED FOR OVERSIZES</i>																				
KX-125 (No. 1794 & 1840) 124cc Liquid Cooled 54mm 2.126"	1996-97	AC	KA-5307	5307K	54.00 54.01 54.50 55.00 56.00	Std. Std. .020 .040 .080	4296A 4296B	652M05400 652M05450 652M05500 652M05600	8112DA 8112DB 8112D050 8112D100 8112D200			T.E. Bearing 01318	Top End C7241	Top End 35-4215 Complete with Oil Seals 37-4215		Pro-X 04970	39-4970	6322X 094484	Bearing / Seal Kit 494484	
<i>CYLINDER SLEEVING REQUIRED FOR OVERSIZES</i>																				
KX-125 (No. 1852) 124cc Liquid Cooled 54mm 2.126"	1998	AC	KA-5354	5354K	54.00 54.01 56.00	Std. Std. .080	4299A 4299B	719M05400 719M05600	8113DA 8113DB 8113D200			T.E. Bearing 01318	Top End C7393	Top End 35-4219 Complete with Oil Seals 37-4218		Pro-X 04940	39-4940	6322X 094484	Bearing / Seal Kit 494484	
<i>CYLINDER SLEEVING REQUIRED FOR OVERSIZES</i>																				
KX-125 (No. 1881) 124cc Liquid Cooled 54mm 2.126"	1999	AC	KA-5354	5354K-1	54.00 54.01 56.00	Std. Std. .080	4299A 4299B	741M05400 741M05600	8057DA 8057DB 8057D200			T.E. Bearing 01318	Top End C7393	Top End 35-4219 Complete with Oil Seals 37-4218		Pro-X 04940	39-4940	6322X 094484	Bearing / Seal Kit 494484	
<i>CYLINDER SLEEVING REQUIRED FOR OVERSIZES</i>																				
KX-125 (No. 1921) 124cc Liquid Cooled 54mm 2.126"	2000	AC	KA-5429	5429K	54.00 54.01 56.00	Std. Std. .080	4299A 4299B	741M05400 741M05600	8057DA 8057DB 8057D200			T.E. Bearing 01318	Top End C7393	Top End 35-4219 Complete with Oil Seals 37-4218		Pro-X 04940	39-4940	6322X 094484	Bearing / Seal Kit 494484	
<i>CYLINDER SLEEVING REQUIRED FOR OVERSIZES</i>																				
KX-125 (No. 1939) 124cc Liquid Cooled 54mm 2.126"	2001	AC	KA-5451	5451K	54.00 54.01 56.00	Std. Std. .080	4221A 4221B	783M05400 783M05600	8062DA 8062DB 8062D200			T.E. Bearing 01318	Top End C7762	Top End 35-4219 Complete with Oil Seals 37-4219		Pro-X 04940	39-4940	6322X 094484	Bearing / Seal Kit 494484	
<i>CYLINDER SLEEVING REQUIRED FOR OVERSIZES</i>																				
KX-125 (No. 1960) 124cc Liquid Cooled 54mm 2.126"	2002	AC	KA-5473	5473K	54.00 54.01 56.00	Std. Std. .080	4221A 4221B	783M05400 783M05600	8062DA 8062DB 8062D200			T.E. Bearing 01318	Top End C7762	Top End 35-4219 Complete with Oil Seals 37-4219		Pro-X 04940	39-4940	6322X 094484	Bearing / Seal Kit 494484	
<i>CYLINDER SLEEVING REQUIRED FOR OVERSIZES</i>																				





MODEL
Engine Description
Cylinder I.D. (mm/in.)



SLEEVE

REBUILD KIT
Sleeve - Piston
Gasket - T.E. Bearing

BORE SIZE (mm)

PISTON SIZE

TOP END

TOP END

BOTTOM END

PRO-X PISTON

WISECO PISTON

WOSSNER PISTON

VERTEX PISTON

T.E. BEARING

COMETIC GASKET

L.A. SLEEVE GASKET

CRANKSHAFT

CON-ROD KIT

CON-ROD ASSEMBLY
Rod - Bearings - Seals

CRANK BEARING

CRANK SEAL KIT

BOTTOM END KIT
Crankshaft - Bearings - Seals - Gasket Set

KAWASAKI TWO-STROKE (CONTINUED)

MODEL	Year	AC	KA	Sleeve	Std. Bore	Std. Piston	PRO-X Piston	Wiseco Piston	Wossner Piston	Vertex Piston	T.E. Bearing	Cometic Gasket	L.A. Sleeve Gasket	Crankshaft	Con-Rod Kit	Con-Rod Assembly	Crank Bearing	Crank Seal Kit	Bottom End Kit
KX-125 (No. 1978) 124cc Liquid Cooled 54mm 2.126"	2003	AC	KA-5485	5485K	54.00 54.01 56.00	Std. Std. .080	4223A 4223B	822M05400 822M05600	8073DA 8073DB 8073D200		T.E. Bearing 01318	Top End C7921	Top End 35-4223 Complete with Oil Seals 37-4223	HR4055	Pro-X 04929	39-4929	6322X Bearing / Seal Kit 494484	094484	Hot Rods CBK0091
KX-125 (No. 0013 & 0026) 124cc Liquid Cooled 54mm 2.126"	2004-05	AC	KA-5570	5570K	54.00 54.01 56.00	Std. Std. .080	4223A 4223B	834M05400 834M05600	8167DA 8167DB 8167D200		T.E. Bearing 01318	Top End C7203	Top End 35-4223 Complete with Oil Seals 37-4223	HR4055	Pro-X 04929	39-4929	6322X Bearing / Seal Kit 494484	094484	Hot Rods CBK0091
KDX-200 KIPS 66mm 2.598"	1986-88	AC	KA-969		66.00 66.01 66.25 66.50 67.00	Std. Std. .010 .020 .040	4310A 4310B 4311 4312	711M06600 711M06650 711M06700	8093DA 8093D050 8093D100		T.E. Bearing 01310	Top End C7042					6305C3 Bearing / Seal Kit 494485	094485	
KDX-200 198cc Liquid Cooled 66mm 2.598"	1989-94	AC	KA-5086	5086K	66.00 66.01 66.25 66.50 67.00	Std. Std. .010 .020 .040	4310A 4310B 4311 4312	711M06600 711M06650 711M06700	8093DA 8093D050 8093D100		T.E. Bearing 01310	Top End C7043	Top End 35-0440 Complete with Oil Seals 37-1440		Pro-X 04986 Hot Rods HR8129	39-4486 (90-91) 39-4487 (92-94)	6305C3	094485 (89) 094486 (90-91) 094487 (92-94)	
KDX-200 198cc Liquid Cooled 66mm 2.598"	1995-06	AC	KA-5252	5252K	66.00 66.01 66.25 66.50 67.00	Std. Std. .010 .020 .040	4310A 4310B 4311 4312	711M06600 711M06650 711M06700	8093DA 8093D050 8093D100		T.E. Bearing 01310	Top End C7242	Top End 35-4285 Complete with Oil Seals 37-4285		Pro-X 04986 Hot Rods HR8129	39-4986	6305C3 Bearing / Seal Kit 494487	094487	
KDX-220 216cc Liquid Cooled 69mm 2.716"	1997-05	AC	KA-5319	5319K	69.00 70.00	Std. .040		750M06900 750M07000	8092DA		T.E. Bearing 01310	Top End C7298	Top End 35-0445 Complete with Oil Seals 37-1445		Pro-X 04986 Hot Rods HR8129	39-4986	6305C3 Bearing / Seal Kit 494487	094487	
KX-250 249cc Liquid Cooled 67.4mm 2.653"	1987	AC	KA-5007		67.40 68.00 68.50 69.00 69.50	Std. .023 .045 .063 .084		556M06740 556M06800 556M06850 556M06900 556M06950	8129DA 8129D060 8129D110 8129D160 8129D210		T.E. Bearing 01337	Top End C7039	Complete with Oil Seals 37-1453		Pro-X 04967 Hot Rods HR8108	39-4967	6328C3 Bearing / Seal Kit 494488	094488	
KX-250 249cc Liquid Cooled 67.4mm 2.653"	1988	AC	KA-5044		67.40 68.00 68.50 69.00 69.50	Std. .023 .045 .063 .084		556M06740 556M06800 556M06850 556M06900 556M06950	8129DA 8129D060 8129D110 8129D160 8129D210		T.E. Bearing 01337	Top End C7040	Complete with Oil Seals 37-1454		Pro-X 04967 Hot Rods HR8108	39-4967	6328C3 Bearing / Seal Kit 494488	094488	



GASGAS
HONDA
HUSQVARNA
KAWASAKI
KTM
SUZUKI
YAMAHA
DIRT BIKE SLEEVES
STREET BIKE SLEEVES
ACCESSORIES
TECHNICAL



MODEL
Engine Description
Cylinder I.D. (mm/in.)



SLEEVE

REBUILD KIT
Sleeve - Piston
Gasket - T.E. Bearing

BORE SIZE (mm)

PISTON SIZE

TOP END

TOP END

BOTTOM END

PRO-X PISTON

WISECO PISTON

WOSSNER PISTON

VERTEX PISTON

T.E. BEARING

COMETIC GASKET

L.A. SLEEVE GASKET

CRANKSHAFT

CON-ROD KIT

CON-ROD ASSEMBLY
Rod - Bearings - Seals

CRANK BEARING

CRANK SEAL KIT

BOTTOM END KIT
Crankshaft - Bearings - Seals - Gasket Set

KAWASAKI TWO-STROKE (CONTINUED)

KX-250 249cc Liquid Cooled 67.4mm 2.653"	1989	AC	KA-5090		67.40 68.00 68.50 69.00 69.50	Std. .023 .045 .063 .084		556M06740 556M06800 556M06850 556M06900 556M06950	8129DA 8129D060 8129D110 8129D160 8129D210				T.E. Bearing 01337	Top End C7040	Complete with Oil Seals 37-1454		Pro-X 04967 Hot Rods HR8108	39-4967	6328C3 Bearing / Seal Kit 494488	094488	
KX-250 H-1 249cc Liquid Cooled 67.4mm 2.653"	1990	AC	KA-5122	5122K	67.40 67.41 68.00 68.50	Std. Std. .025 .045	4306B 4306C	607M06740 607M06800 607M06850	8109DA 8109DB 8109D060 8109D110				T.E. Bearing 01337	Top End C7040	Complete with Oil Seals 37-1455		Pro-X 04967 Hot Rods HR8108	39-4967	6328C3 Bearing / Seal Kit 494488	094488	
KX-250 (No. 1643) 249cc Liquid Cooled 67.4mm 2.653"	1991	AC	KA-5123	5123K	67.40 67.41 68.00 68.50	Std. Std. .025 .045	4306B 4306C	607M06740 607M06800 607M06850	8109DA 8109DB 8109D060 8109D110				T.E. Bearing 01337	Top End C7041	Complete with Oil Seals 37-1455		Pro-X 04967 Hot Rods HR8108	39-4967	6328C3 Bearing / Seal Kit 494488	094488	
KX-250 (No. 1671) 249cc Liquid Cooled 66.4mm 2.614"	1992	AC	KA-5153	5153K	66.40 66.41 67.00 67.50 68.00 68.50	Std. Std. .025 .045 .065 .085	4308B 4308C	617M06640 617M06700 617M06750 617M06850	8026DA 8026DB 8026D060 8026D110 8026D160	VT22244B			T.E. Bearing 01337	Top End C7100	Complete with Oil Seals 37-1456	HR4017	Pro-X 04967 Hot Rods HR8108	39-4967	6328C3 Bearing / Seal Kit 494488	094488	Hot Rods CBK0054
KX-250 (No. 1686) 249cc Liquid Cooled 66.4mm 2.614"	1993	AC	KA-5180	5180K	66.40 66.41 67.00 67.50 68.00 68.50	Std. Std. .023 .043 .065 .085	4308B 4308C	617M06640 617M06700 617M06750 617M06850	8026DA 8026DB 8026D060 8026D110 8026D160	VT22244B			T.E. Bearing 01337	Top End C7135	Top End 35-4313 Complete with Oil Seals 37-1478	HR4017	Pro-X 04967 Hot Rods HR8108	39-4967	6328C3 Bearing / Seal Kit 494488	094488	Hot Rods CBK0058
KX-250 (No. 1722) 249cc Liquid Cooled 66.4mm 2.614"	1994	AC	KA-5209	5209K	66.40 66.41 67.00 67.50 68.00 68.50	Std. Std. .023 .043 .065 .085	4308B 4308C	617M06640 617M06700 617M06750 617M06850	8026DA 8026DB 8026D060 8026D110 8026D160	VT22244B			T.E. Bearing 01337	Top End C7155	Top End 35-4313 Complete with Oil Seals 37-1478	HR4017	Pro-X 04967 Hot Rods HR8108	39-4967	6328C3 Bearing / Seal Kit 494488	094488	Hot Rods CBK0058
KX-250 (No. 1751) 249cc Liquid Cooled 66.4mm 2.614"	1995	AC	KA-5253	5253K	66.40 66.41 67.00 67.50 68.00 68.50	Std. Std. .023 .043 .065 .085	4308B 4308C	617M06640 617M06700 617M06750 617M06850	8026DA 8026DB 8026D060 8026D110 8026D160	VT22244B			T.E. Bearing 01337	Top End C7155	Top End 35-4313 Complete with Oil Seals 37-1478	HR4017	Pro-X 04967 Hot Rods HR8108	39-4967	6328C3 Bearing / Seal Kit 494488	094488	Hot Rods CBK0058
KX-250 (No. 1793) 249cc Liquid Cooled 66.4mm 2.614"	1996	AC	KA-5294	5294K	66.40 66.41 67.00 67.50 68.00 68.50	Std. Std. .023 .043 .065 .085	4308B 4308C	617M06640 617M06700 617M06750 617M06850	8026DA 8026DB 8026D060 8026D110 8026D160	VT22244B			T.E. Bearing 01337	Top End C7155	Top End 35-4313 Complete with Oil Seals 37-1478	HR4017	Pro-X 04967 Hot Rods HR8108	39-4967	6328C3 Bearing / Seal Kit 494488	094488	Hot Rods CBK0058





MODEL
Engine Description
Cylinder I.D. (mm/in.)



SLEEVE

REBUILD KIT
Sleeve - Piston
Gasket - T.E. Bearing

BORE SIZE (mm)

PISTON SIZE

TOP END

TOP END

BOTTOM END

PRO-X PISTON

WISECO PISTON

WOSSNER PISTON

VERTEX PISTON

T.E. BEARING

COMETIC GASKET

L.A. SLEEVE GASKET

CRANKSHAFT

CON-ROD KIT

CON-ROD ASSEMBLY
Rod - Bearings - Seals

CRANK BEARING

CRANK SEAL KIT

BOTTOM END KIT
Crankshaft - Bearings - Seals - Gasket Set

KAWASAKI TWO-STROKE (CONTINUED)

MODEL	Year	AC	KA	Sleeve Part No.	Bores	Std. Piston	Over Size Piston	Pro-X Piston	Wiseco Piston	Wossner Piston	Vertex Piston	T.E. Bearing	Top End Gasket	L.A. Sleeve Gasket	Crankshaft	Con-Rod Kit	Con-Rod Assembly	Crank Bearing	Crank Seal Kit	Bottom End Kit
KX-250 (No. 1835) Liquid Cooled 249cc 66.4mm	1997	AC	KA-5321	5321K	66.40 66.41 67.00 67.50 68.00 68.50	Std. Std. .023 .043 .065 .085		4308B 4308C	617M06640 617M06700 617M06750 617M06850	8026DA 8026DB 8026D060 8026D110 8026D160	VT22244B	T.E. Bearing 01337	Top End C7155	Top End 35-4313 Complete with Oil Seals 37-4313	HR4017	Pro-X 04967 Hot Rods HR8108	39-4967	6328C3 Bearing / Seal Kit 494488	094488	Hot Rods CBK0055
KX-250 (No. 1851) Liquid Cooled 249cc 66.4mm	1998-99	AC	KA-5350	5350K	66.40 66.41 67.00 67.50 68.00 68.50	Std. Std. .023 .043 .065 .085		4308B 4308C	617M06640 617M06700 617M06750 617M06850	8026DA 8026DB 8026D060 8026D110 8026D160	VT22521B	T.E. Bearing 01337	Top End C7155	Top End 35-4313 Complete with Oil Seals 37-4313	HR4017	Pro-X 04967 Hot Rods HR8108	39-4967	6328C3 Bearing / Seal Kit 494488	094488	Hot Rods CBK0055
KX-250 (No. 1911) Liquid Cooled 249cc 66.4mm	2000	AC	KA-5422	5422K	66.40 66.41 67.00 67.50 68.00 68.50	Std. Std. .023 .043 .065 .085		4308B 4308C	617M06640 617M06700 617M06750 617M06850	8026DA 8026DB 8026D060 8026D110 8026D160	VT22521B	T.E. Bearing 01337	Top End C7155	Top End 35-4313 Complete with Oil Seals 37-4313	HR4017	Pro-X 04967 Hot Rods HR8108	39-4967	6328C3 Bearing / Seal Kit 494488	094488	Hot Rods CBK0055
KX-250 (No. 1938) Liquid Cooled 249cc 66.4mm	2001	AC	KA-5481	5481K	66.40 66.41 67.00 67.50 68.00 68.50	Std. Std. .023 .043 .065 .085		4308B 4308C	617M06640 617M06700 617M06750 617M06850	8026DA 8026DB 8026D060 8026D110 8026D160	VT22521B	T.E. Bearing 01337	Top End C7764	Top End 35-4313 Complete with Oil Seals 37-4313	HR4017	Pro-X 04967 Hot Rods HR8108	39-4967	6328C3 Bearing / Seal Kit 494488	094488	Hot Rods CBK0055
KX-250 (No. 1959 & 1979) Liquid Cooled 249cc 66.4mm	2002-03	AC	KA-5471	5471K	66.40 66.41 67.50	Std. Std. .043		4308B 4308C	799M06640 799M06750	8088DA 8088DB 8088D110	VT22795B	T.E. Bearing 01337	Top End C7861	Top End 35-4313 Complete with Oil Seals 37-4313	HR4017	Pro-X 04967 Hot Rods HR8108	39-2872	B32872 Bearing / Seal Kit 492872	094488	Hot Rods CBK0055
KX-250 (No. 0014) Liquid Cooled 249cc 66.4mm	2004	AC	KA-5538	5538K	66.40 66.41 67.50	Std. Std. .043		4308B 4308C	799M06640 799M06750	8088DA 8088DB 8088D110	VT22795B	T.E. Bearing 01337	Top End C7269	Top End 35-4316 Complete with Oil Seals 37-4316	HR4017	Pro-X 04967 Hot Rods HR8108	39-2872	B32872 Bearing / Seal Kit 492872	094488	Hot Rods CBK0057
KX-250 (No. 0027) Liquid Cooled 249cc 66.4mm	2005-07	AC	KA-5582	5582K	66.40 66.41 68.50	Std. Std. .083		4315B 4315C	843M06640 843M06850	8168DA 8168DB 8168D210	VT23124B	T.E. Bearing 01337	Top End C3096	Top End 35-4322 Complete with Oil Seals 37-4322	HR4057	Pro-X 04967 Hot Rods HR8108	39-2872	B32872 Bearing / Seal Kit 492872	094488	Hot Rods CBK0093
KDX-250 D Liquid Cooled 249cc 67.4mm	1991-94	AC	KA-5079		67.40 67.41 68.00 68.50	Std. Std. .025 .045		4306B 4306C	607M06740 607M06800 607M06850	8109DA 8109DB 8109D060 8109D110		T.E. Bearing 01337	Top End C7134			Pro-X 04967 Hot Rods HR8108		6328C3 Bearing / Seal Kit 494488	094488	

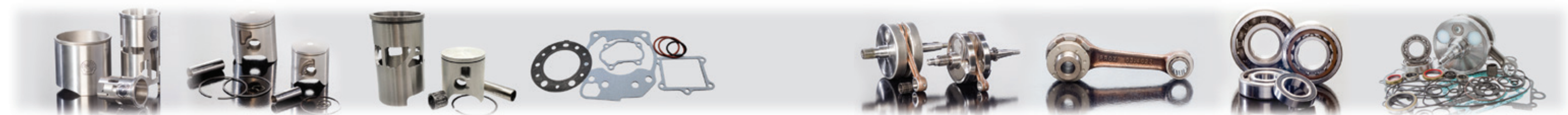

GASGAS
HONDA
HUSQVARNA
KAWASAKI
KTM
SUZUKI
YAMAHA
DIRT BIKE SLEEVES
STREET BIKE SLEEVES
ACCESSORIES
TECHNICAL



MODEL
Engine Description
Cylinder I.D. (mm/in.)



SLEEVE

REBUILD KIT
Sleeve - Piston
Gasket - T.E. Bearing

BORE SIZE (mm)

PISTON SIZE

TOP END

TOP END

BOTTOM END

PRO-X PISTON

WISECO PISTON

WOSSNER PISTON

VERTEX PISTON

T.E. BEARING

COMETIC GASKET

L.A. SLEEVE GASKET

CRANKSHAFT

CON-ROD KIT

CON-ROD ASSEMBLY
Rod - Bearings - Seals

CRANK BEARING

CRANK SEAL KIT

BOTTOM END KIT
Crankshaft - Bearings - Seals - Gasket Set

KAWASAKI TWO-STROKE (CONTINUED)

MODEL	Year	AC	KA	Sleeve	Piston	Wrist Pin	PRO-X PISTON	WISECO PISTON	WOSSNER PISTON	VERTEX PISTON	T.E. BEARING	COMETIC GASKET	L.A. SLEEVE GASKET	CRANKSHAFT	CON-ROD KIT	CON-ROD ASSEMBLY	CRANK BEARING	CRANK SEAL KIT	BOTTOM END KIT	
KX-500 KIPS 499cc Liquid Cooled 86mm 3.386"	1986-87	AC	KA-956																	6306C3 094489
KX-500 KIPS 499cc Liquid Cooled 86mm 3.386"	1988	AC	KA-5008	5008K	86.00 86.01 86.50 87.00 87.50 88.00	Std. Std. .020 .040 .060 .080	4330A 4330B	575M08600 575M08650 575M08700 575M08800	8228DA 8228D050 8228D100 8228D150 8228D200		T.E. Bearing B1036	Top End C7045	Complete with Oil Seals 37-1475		Hot Rods HR8148 Wossner WR2039				6306C3 094489 Bearing / Seal Kit 494489	
KX-500 Big Bore to 540cc 90mm 3.543"	1986-88	AC	KA-5008B		90.00 91.00				W5008P4 W5008P8		T.E. Bearing B1036	Top End GS5008				Hot Rods HR8148 Wossner WR2039				6306C3 094489 Bearing / Seal Kit 494489
KX-500 E-1 499cc Liquid Cooled 86mm 3.386"	1989-04	AC	KA-5087	5087K (89-90) 5087K-1 (91-04)	86.00 86.01 86.50 87.00 87.50 88.00	Std. Std. .020 .040 .060 .080	4330A 4330B	575M08600 575M08650 575M08700 575M08800	8228DA 8228D050 8228D100 8228D150 8228D200		T.E. Bearing B1036	Top End C7046 (89-90) C7047 (91-04)	Top End 35-4408 Complete with Oil Seals 37-4408		Hot Rods HR8148 Wossner WR2039	39-4996			6306C3 094489 Bearing / Seal Kit 494489	
KX-500 Big Bore to 540cc 90mm 3.543"	1989-04	AC	KA-5087B		90.00 91.00				W5008P4 W5008P8		T.E. Bearing B1036	Top End GS5087				Hot Rods HR8148 Wossner WR2039				6306C3 094489 Bearing / Seal Kit 494489



GASGAS
HONDA
HUSQVARNA
KAWASAKI
KTM
SUZUKI
YAMAHA
DIRT BIKE SLEEVES
STREET BIKE SLEEVES
ACCESSORIES
TECHNICAL



MODEL
Engine Description
Cylinder I.D. (mm/in.)

SLEEVE

REBUILD KIT
Sleeve • Piston
Gasket • T.E. Bearing

BORE SIZE (mm)

PISTON SIZE

TOP END

TOP END

VALVE TRAIN

BOTTOM END

PRO-X PISTON

WISECO PISTON

WOSSNER PISTON

VERTEX PISTON

JE PISTON

COMETIC GASKET

L.A. SLEEVE GASKET

CYLINDER AFTERMARKET KITS

VALVE / SPRING KIT

VALVE GUIDE

CAMSHAFT

CAM CHAIN

CRANKSHAFT

CON-ROD KIT

CRANK BEARING

ENGINE OIL SEAL KIT

BOTTOM END KIT
Crankshaft • Bearings • Seals • Gasket Set

KAWASAKI FOUR-STROKE

MODEL	Year	Configuration	Part No.	BORE SIZE (mm)	PISTON SIZE	PRO-X PISTON	WISECO PISTON	WOSSNER PISTON	VERTEX PISTON	JE PISTON	COMETIC GASKET	L.A. SLEEVE GASKET	CYLINDER AFTERMARKET KITS	VALVE / SPRING KIT	VALVE GUIDE	CAMSHAFT	CAM CHAIN	CRANKSHAFT	CON-ROD KIT	CRANK BEARING	ENGINE OIL SEAL KIT	BOTTOM END KIT		
KLX-110, R 112cc 53mm	2002-24 Single 2.086"	RS	KA-5493	53.00 53.50 54.00	Std. .020 .040			11:1 Comp. 4875M05350 4875M05400				Top End C7939-EST		Top End 35-0415 Complete w/oil seals 37-1415									49-822216	
KLX110 to 150cc 61mm	2.401"	BB/L	KA-5493B																					
KLX-125 124cc 57mm	2003-06 Single 2.244"	CI	FL-753	57.00 58.00 61.00	Std. .040 .160			11:1 Comp. 4815M05700 4815M05800 4815M06100				Top End C7940 (59mm) C7950 (61mm)		Top End 35-0531 Complete w/ oil seals 37-1531									49-822226	
KLX-140R F,L 144cc 58mm	2008-24 Single 2.283"	RS	KA-5697									Top End 35-0033												49-822399
KLX-230, R, SM 233cc 67mm	2020-24 Single 2.637"	AC	KA5825																					
KL, KLR-250 249cc 74mm	1984-05 Liquid Cooled 2.913"	RS	KA-5018									Top End C7244		Top End 35-0459										49-822136
KL-250 Super Sherpa 2000-03, 2009-10 249cc 72mm	Single 2.835"	AC	KA-5432																					
KLX-250 R 247cc 72mm	1994-96 Liquid Cooled 2.835"	AC	KA-5247									Top End C7214		Top End 35-0460		Steel Exhaust 40-4373H Steel Intake 40-4372H Valve Spring Kit 40-40008	Valve Guide IN / EX 40-4420						49-822137	
KLX-250S 2006-14, '18-20 249cc 72mm	Liquid Cooled 2.834"	AC	KA-5637													Steel Exhaust 40-4373H Steel Intake 40-4372H	Valve Guide IN / EX 40-4420						49-822137	
KX-250F 249cc 77mm	2004-05 Liquid Cooled 3.031"	AC	KA-5530	5530K 77.00 79.00	Std. .080	12.6:1 Comp. 01.4335A 4358	13.1:1 Comp. 4842M07700 4842M07900	12.5:1 Comp. 8582DA	12.6:1 Comp. VT22982A	13.5:1 Comp. 243642		Top End C3174-EST (77mm) C3054-EST (78mm) C3056-EST (80mm)	Top End 35-4334 Complete w/ oil seals 37-1463	Cylinder Works 30001 (Std. 77mm) Cylinder Works Complete Kit 30001-K01 (Std. 77mm)	Titanium Exhaust 28-43341 Titanium Intake 28-43342 Steel Exhaust 40-40143H Steel Intake 40-40140H Valve Spring Kit 40-40100	Valve Guide IN / EX 40-40120	Hot Cams Stage 1 2041-11N (Intake) 2040-1E (Exhaust) Stage 2 2067-21N (Intake) 2068-2E (Exhaust)	CC-2402	HR4064	Pro-X 04919	6206RI Bearing / Seal Kit 49K043	49-822223	Hot Rods CBK0099	
<p><i>RESLEEVEING REQUIRED FOR OVERSIZES</i></p> <p><i>CYL. WORKS COMPLETE KIT INCLUDES CYLINDER, PISTON, TOP END GASKETS</i></p>																								

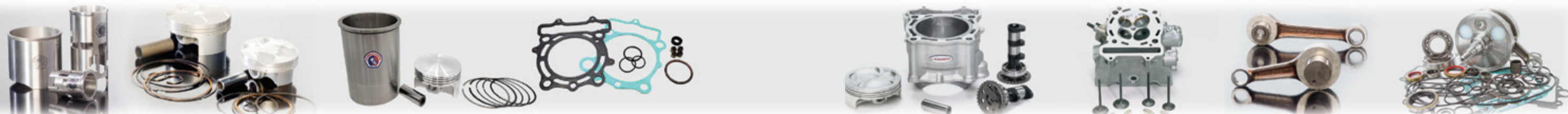

GASGAS
HONDA
HUSQVARNA
KAWASAKI
KTM
SUZUKI
YAMAHA
DIRT BIKE SLEEVES
STREET BIKE SLEEVES
ACCESSORIES
TECHNICAL



MODEL
Engine Description
Cylinder I.D. (mm/in.)



SLEEVE

REBUILD KIT
Sleeve • Piston
Gasket • T.E. Bearing

BORE SIZE (mm)

PISTON SIZE

TOP END

TOP END

VALVE TRAIN

BOTTOM END

PRO-X PISTON

WISECO PISTON

WOSSNER PISTON

VERTEX PISTON

JE PISTON

COMETIC GASKET

L.A. SLEEVE GASKET

CYLINDER AFTERMARKET KITS

VALVE / SPRING KIT

VALVE GUIDE

CAMSHAFT

CAM CHAIN

CRANKSHAFT

CON-ROD KIT

CRANK BEARING

ENGINE OIL SEAL KIT

BOTTOM END KIT
Crankshaft • Bearings •
Seals • Gasket Set

KAWASAKI FOUR-STROKE (CONTINUED)

MODEL	Year	AC	KA-#	Sleeve	Piston	Comp.	Comp.	Comp.	Comp.	Comp.	Top End	Top End	Cylinder Works	Exhaust	Intake	Valve Guide	Camshaft	CC-#	HR-#	Pro-X	Bearing / Seal Kit	Hot Rods		
KX-250F 249cc Liquid Cooled 77mm 3.031" <i>RESLEEVE REQUIRED FOR OVERSIZES</i> <i>CYL. WORKS COMPLETE KIT INCLUDES CYLINDER, PISTON, TOP END GASKETS</i>	2006-11	AC	KA-5611	5611K (06-08)	77.00	Std.	(06-09) 13.5:1 Comp. 4380A	(06-09) 13.5:1 Comp. 4920M07700	(06-09) 13.5:1 Comp. 8635DA	(06-09) 13.5:1 Comp. VT23259A	(06-09) 13.8:1 Comp. 247596	Top End (06-08) C3174-EST	Top End (06-08) 35-4334	Cylinder Works Std. 77mm 30001 (06-08)	Titanium Exhaust 28-43341	Valve Guide IN / EX (06) 40-40120	Camshaft Hot Cams 2004-10 (Intake) Stage 1 2041-1IN	CC-2402	(06-08) HR4064	Pro-X (04-09) 04919	6206RI	49-822316	Hot Rods (06-08) CBK0028	
				5611K-1 (2009)	77.01	Std.	(06-09) 13.5:1 Comp. 4380B	(06-09) 13.5:1 Comp. 4920M07700	(06-09) 8635DB	(06-09) VT23259B	(06-09) 247596	(09-11) 35-0481	30004 (2009)	Titanium Intake 28-43342 (06-08)	2007-11 Intake 40-40520	2004-10 (Intake) Stage 1 2041-1IN	(2009) HR4096	(10-11) 03.4340	(2009) CBK0127					
				77.00	Std.	(10) 13.2:1 Comp. 01.4340A	(10) 13.2:1 Comp. 40009M07700	(10) 8777DA	(10) VT23566A	(06-09) 274179	(06-09) 14:1 Comp. 274179	Complete w/ oil seals (06-08) 37-4334	30005 (2010)	28-43392 (09-11)	Exhaust 40-40520	Stage 2 2067-2IN	(2010) HR4020	Hot Rods (06-09) HR8622	(2010) CBK0060					
				77.01	Std.	(11-12) 13.5:1 Comp. 01.4342A	(11-12) 13.5:1 Comp. 40019M07700	(11-12) 8814DA	(11-12) VT23646A	(10-12) 292759	(10-12) 292759	(09-11) 37-1481	30006 (2011)	Kibblewhite Steel Exhaust 40-40143H	Valve Seals Pkg. of 4 71013-4	(Exhaust) Stage 1 2040-1E	(2011) HR4021	(10-11) HR8690	(2011) CBK0061					
				77.00	Std.	(10-12) 14.5:1 Comp. 40020M07700	(10-12) 14:1 Comp. 292760							Complete Kit 30001-K01 (06-08)	Steel Intake 40-40140H	Stage 2 2068-2E								
KX-250F 249cc Liquid Cooled 77mm 3.031" <i>RESLEEVE REQUIRED FOR OVERSIZES</i> <i>CYL. WORKS COMPLETE KIT INCLUDES CYLINDER, PISTON, TOP END GASKETS</i>	2012-16	AC	KA-5611	77.00	Std.	(12-14) 13.5:1 Comp. 01.4342A	(12-14) 13.5:1 Comp. 40019M07700	(12-14) 8814DA	(12-14) VT23646A	(12-14) 292759	Top End C3267-EST	Top End 35-0481	Cylinder Works Std. 77mm 30006	Titanium Exhaust 28-43341	Valve Guide Intake 40-40520	Camshaft Hot Cams (Intake) Stage 1 2218-1IN	CC-2402	HR4021	Pro-X 03.4342	6206RI	49-822316			
				77.01	Std.	(15-16) 13.8:1 Comp. 01.4345A	(15-16) 13.8:1 Comp. 40124M07700	(15-16) 8921DA	(15-16) VT24020A	(15-16) 8921DB	(15-16) VT24040B	Complete w/ oil seals 37-1481	30006-K01 (12-14)	Titanium Intake 28-43392	Exhaust 40-40120	(Exhaust) Stage 1 2219-1E	Hot Rods HR8690							
KX-250F 249cc Liquid Cooled 77mm 3.031" <i>CYL. WORKS COMPLETE KIT INCLUDES CYLINDER, PISTON, TOP END GASKETS</i>	2017-19	AC	KA-5611	77.00	Std.	13.7:1 Comp. 01.4348A	13.7:1 Comp. 40165M07700	14:1 Comp. 8932DA	13.4:1 Comp. VT24267A	13.7:1 Comp. 345199	Top End C3619	Top End 35-0984	Cylinder Works Std. 77mm 30012	Titanium Exhaust 28-43471		Hot Cams (Intake) Stage 1 & 2 2313-2IN	CC-4347		Pro-X 03.4347	6206RI	49-822977			
				77.01	Std.	01.4348B	40165M07700	8932DB	VT24267B			Complete w/ oil seals 37-1984	30012-K02	Titanium Intake 28-43472		(Exhaust) Stage 1 & 2 2312-E	Wossner WR4074							
KX-250F Big Bore to 270cc 80mm 3.150" 270cc <i>CYL. WORKS COMPLETE KIT INCLUDES CYLINDER, PISTON, TOP END GASKETS</i>	2004-05 2006-19	AC	KA-5330B	80.00	.120			(06-09) 13.5:1 Comp. 8635D300	(04-09) 12.6:1 Comp. VT23405A	(06-09) 13.5:1 comp. 247598	Top End (04-08) C3056-EST (80mm)	Top End	Cylinder Works Complete Kit 270cc, 80mm 31001-K01 (04-08)											
				80.00	.120			(10) 13.2:1 Comp. 8777D300	(10) 13.2:1 Comp. VT23680A			(09-16) 31004-G01 (80mm)	31004-K01 (2009)											
				80.00	.120			(11-14) 13.5:1 Comp. 8814D300	(11-14) 13.5:1 Comp. VT23654A			(17-19) 31012-G01 (80mm)	31005-K01 (2010)											
				80.00	.120				(15-16) 13.8:1 comp. VT24032A				31006-K01 (11-14)											
				80.00	.120				(17-19) 13.7:1 Comp. VT24237A				31006-K02 (15-16)											

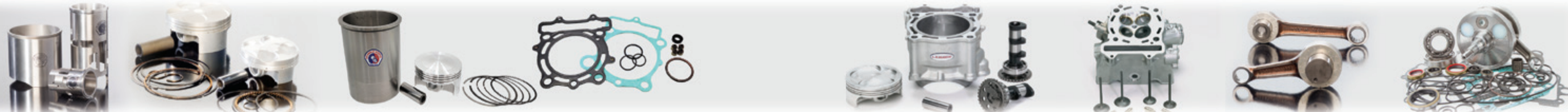

GASGAS
HONDA
HUSQVARNA
KAWASAKI
KTM
SUZUKI
YAMAHA
DIRT BIKE SLEEVES
STREET BIKE SLEEVES
ACCESSORIES
TECHNICAL



MODEL
Engine Description
Cylinder I.D. (mm/in.)

SLEEVE

REBUILD KIT
Sleeve • Piston
Gasket • T.E. Bearing

BORE SIZE (mm)

PISTON SIZE

TOP END

TOP END

VALVE TRAIN

BOTTOM END

PRO-X PISTON

WISECO PISTON

WOSSNER PISTON

VERTEX PISTON

JE PISTON

COMETIC GASKET

L.A. SLEEVE GASKET

CYLINDER AFTERMARKET KITS

VALVE / SPRING KIT

VALVE GUIDE

CAMSHAFT

CAM CHAIN

CRANKSHAFT

CON-ROD KIT

CRANK BEARING

ENGINE OIL SEAL KIT

BOTTOM END KIT
Crankshaft • Bearings • Seals • Gasket Set

KAWASAKI FOUR-STROKE (CONTINUED)

MODEL	Year	AC	Part No.	81-88	89-92	(19-20)	(19-20)	(19-20)	(19-20)	(19-20)	Top End	Top End	Cylinder Works	Exhaust	Valve Guide	CC	CRANKSHAFT	CON-ROD KIT	CRANK BEARING	ENGINE OIL SEAL KIT	BOTTOM END KIT	
KX-250 KX-250X 249cc 78mm Liquid Cooled 3.071" <i>CYL. WORKS COMPLETE KIT INCLUDES CYLINDER, PISTON, TOP END GASKETS</i>	2019-24	AC	KA-5816	78.00	Std.	14.2:1 Comp. 01.4350A 01.4350B	14.2:1 40245M07800	14.4:1 Comp. 8966DA 8966DB	14.2:1 Comp. VT24456A VT24456B	14.4:1 Comp. 371309	Top End (19-20) C3787	Top End (19-20) 35-0051	Cylinder Works (20) Complete Kit 30016-K01 (Std. 78mm)	Titanium Exhaust 40-41616T	Valve Guide Intake 40-41620	(19) CC-4347		Pro-X (19-20) 03.4347	6206RI	(19-20) 49-822977		
	2021-24			78.01	Std.	(21-23) 14.1:1 Comp. 01.4351A 01.4351B	(21-23) 14.1:1 Comp. 40273M07800	(21-23) 14.1:1 Comp. 8989DA 8989DB	(21-23) 14.1:1 Comp. VT24509A VT24509B	(21-23) 14.5:1 Comp. 379030	(21-23) C3803	(21-23) 35-0053	(21-23) Complete Kit 30017-K01 (Std. 78mm)	Titanium Intake 40-41612T	Exhaust 40-41630	(20) CC-2429		(21-23) 03.4351	Bearing / Seal Kit (19-20) 49K043 (21-23) 49-43051	(21-23) 49-822403		
KX-250, KX250X Big Bore to 270cc 81mm 3.189" <i>RESLEEING REQUIRED FOR OVERSIZES</i>	2019-23	BB	KA-5816B	81.00	.120				14.1:1 Comp. VT24637A													
KLX-300 292cc 78mm Liquid Cooled 3.071" <i>RESLEEING REQUIRED FOR OVERSIZES</i>	1997-07	AC	KA-5339	78.00	Std.		11:1 Comp. 4630M07800 4630M08000	11:1 Comp. 8644DA 8644D200			Top End C7302	Top End 35-0461		Steel Exhaust 40-4373H	Valve Guide IN / EX 40-4420						49-822137	
	2021-24			80.00	.080						C7420 (80mm)	Complete w/ oil seals 37-1461		Steel Intake 40-4372H	Valve Seals Pkg. of 4 71013-4							
KLX-300R KLX-300 SM 292cc 78mm Liquid Cooled 3.071"	2020-24	AC	KA-5339	78.00	Std.																	
KLX-400R KLX-400SR 398cc 90mm Liquid Cooled 3.543" <i>RESLEEING REQUIRED FOR OVERSIZES</i> <i>CYL. WORKS COMPLETE KIT INCLUDES CYLINDER, PISTON, TOP END GASKETS</i>	2003	AC	FL-5430	5430K (12.25:1)	90.00	Std.	12.2:1 Comp. 5220A 5220B 5224	12.25:1 Comp. 4713M09000	12.2:1 Comp. 8563DA	11.3:1 Comp. VT22951A VT22951B	12:1 Comp. 180297	Top End C7688-EST	Cylinder Works Complete Kit Std. 90mm 40001-K01	Steel Exhaust 28-34021	Valve Guide IN / EX 40-40170	Hot Cams Camshaft 2249-11N (Intake)	CC-3403	HR4059	Pro-X 04921	6306RI	49-822193	
	2003			90.01	Std.	13.5:1 Comp. 4714M09000 4714M09200	13.5:1 Comp. 4713M09200	13.5:1 Comp. 8567DA	13.5:1 Comp. VT23550A	13.5:1 Comp. 208659	199657	Complete w/ oil seals 37-3402		Steel Intake 28-34022		2250-1E (Exhaust)			Hot Rods HR8630	Bearing / Seal Kit 49K049		
KLX-400R KLX-400SR Big Bore 434cc 440cc 450cc <i>CYL. WORKS COMPLETE KIT INCLUDES CYLINDER, PISTON, TOP END GASKETS</i>	2003	BB	FL-5430B	94.00	.160		12.5:1 Comp. 4795M09450	12:1 Comp. 8563D400	11.3:1 comp. VT23533A	12:1 Comp. 183051	Top End C7963-EST (95mm)	Top End GS5430 (97mm)	Cylinder Works Complete Kit 41001-K01 (434cc, 94mm)	Steel Exhaust 28-34021	Valve Guide IN / EX 40-40170	Hot Cams 2249-11N (Intake)	CC-3403					
	2003			94.50	.180			8563D550			13:1 Comp. 243651	C7980 (97mm)		Steel Intake 28-34022		2250-1E (Exhaust)						
KLX-450R 449cc 96mm Liquid Cooled 3.780" <i>RESLEEING REQUIRED FOR OVERSIZES</i>	2008-20	AC	KA-5607	5607K (08-12)	96.00	Std.	12:1 comp. 4390A 4390B 4398	12:1 Comp. 4900M09600	12:1 Comp. 8648DA 8648DB			Top End 35-0469		Steel Exhaust 40-40716	Valve Guide IN / EX 40-40720	Hot Cams (08-12) Stage 1 (Intake) 2196-11N	CC-4406	HR4018	Pro-X 04910	Bearing / Seal Kit 49K056	Hot Rods (08-12) CBK0059	
				96.01	Std.							Complete w/ oil seals 37-1480 (08-18)		Steel Intake 40-40712	O/S+.001 40-40721	(Exhaust) 2197-1E			Hot Rods HR8656			

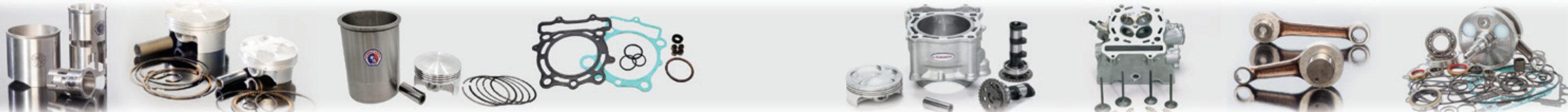

GASGAS
HONDA
HUSQVARNA
KAWASAKI
KTM
SUZUKI
YAMAHA
DIRT BIKE SLEEVES
STREET BIKE SLEEVES
ACCESSORIES
TECHNICAL



MODEL
Engine Description
Cylinder I.D. (mm/in.)



SLEEVE

REBUILD KIT
Sleeve • Piston
Gasket • T.E. Bearing

BORE SIZE (mm)

PISTON SIZE

TOP END

TOP END

VALVE TRAIN

BOTTOM END

PRO-X PISTON

WISECO PISTON

WOSSNER PISTON

VERTEX PISTON

JE PISTON

COMETIC GASKET

L.A. SLEEVE GASKET

CYLINDER AFTERMARKET KITS

VALVE / SPRING KIT

VALVE GUIDE

CAMSHAFT

CAM CHAIN

CRANKSHAFT

CON-ROD KIT

CRANK BEARING

ENGINE OIL SEAL KIT

BOTTOM END KIT
Crankshaft • Bearings • Seals • Gasket Set

KAWASAKI FOUR-STROKE (CONTINUED)

KX-450F 2006-08 449cc Liquid Cooled 96mm 3.780" <i>RESLEEVEING REQUIRED FOR OVERSIZES</i>	AC	KA-5607	5607K	96.00	Std.	12:1 Comp.	12:1 Comp.	12:1 Comp.	12:1 Comp.	12:8:1 Comp.	Top End	C3136-EST (96mm)	Top End	35-0469	Titanium Exhaust 28-44061	Valve Guide IN / EX 40-40320	Hot Cams Stage 1 2071-E (Exhaust)	CC-4406	HR4082 (07-08)	Pro-X 04910	49-822319	Hot Rods (07-08) CBK0118							
				96.01	Std.	4390A	4900M09600	8648DA	VT23242A	284852	C3146-EST (98mm)												Complete w/ oil seals 37-1469	Titanium Intake 28-44062	O/S+.001 40-40321	Stage 2 2187-2IN (Intake)	Hot Rods HR8656	Bearing / Seal Kit 49K056 49K091	
KX-450F 2009-18 449cc Liquid Cooled 96mm 3.780" <i>CYL. WORKS COMPLETE KIT INCLUDES CYLINDER, PISTON, TOP END GASKETS</i>	AC	KA-5698	5698K (09-12)	96.00	Std.	(09-12) 12.5:1 Comp.	(09-12) 12.5:1 Comp.	(09-12) 12.5:1 Comp.	(09-12) 12.5:1 Comp.	(09-14, 16-18) 12.8:1 Comp.	Top End	C3268-EST	Top End	(09-15) 35-0482	Titanium Exhaust 28-44091 (09-18)	Valve Guide IN / EX 40-40670	Hot Cams Stage 1 (09-15) 2185-1IN (Intake)	CC-4409	(2009) HR4094	Pro-X 03.4409	(09-15) 49-822319	Hot Rods (2009) CBK0125							
				96.01	Std.	4409A	4980M09600	8738DA	VT23445A	284852	(16-18) 35-0485												Titanium Intake (09-15) 28-44092	O/S+.001 40-40671	Stage 2 2186-1E (Exhaust)	(10-15) HR4019	Hot Rods HR8684	(16-18) 49-822485	(10-15) CBK0171
				96.00	Std.	(13-14, 16-18) 12.5:1 Comp.	(13-14, 16-18) 12.5:1 Comp.	(13-14) 12.5:1 Comp.	(13-14, 16-18) 12.5:1 Comp.	(16-18) C3598-EST	Complete w/ oil seals (09-15) 37-1482												(16-18) 28-44162	Valve Seals Pkg. of 4 71016-4	Stage 2 (09-18) 2187-2IN (Intake)	Bearing / Seal Kit 49K091			
				96.01	Std.	4413A	40082M09600	8890DA	VT23857A	(15) 37-1485	30011-K01 (09-12)												(16-18) 2188-2E (Exhaust)	Exhaust (09-15) 2188-2E (16-18) 2317-2E					
96.00	Std.	(15) 12.8:1 Comp.	(15) 12.8:1 Comp.	(15) 12.8:1 Comp.	(15) 12.8:1 Comp.		(16-18) 37-1485	30011-K02 (13-14)																					
96.01	Std.	4415A	40125M09603	8920DA	VT24018A			30011-K03 (15)																					
96.00	Std.			8931DA																									
96.01	Std.	4415B		8931DB																									
KX-450 F 2019-23 KX-450 X 2021-23 449cc Liquid-Cooled 96mm 3.780"	AC	KA-5698		96.00	Std.	12.5:1 Comp.	12.5:1 Comp.	12.6:1 Comp.	12.5: Comp.		Top End	C3696	Top End	(19-20) 35-0023	Titanium Exhaust 28-44191			CC-2706		Pro-X 03.4419	49-822379								
				96.01	Std.	4429A	40228M09600	8958DA	VT24368A	(21-23) C3806	(21-23) 35-0055												Titanium Intake 28-44192						



GASGAS
HONDA
HUSAVARNA
KAWASAKI
KTM
SUZUKI
YAMAHA
DIRT BIKE SLEEVES
STREET BIKE SLEEVES
ACCESSORIES
TECHNICAL



MODEL
Engine Description
Cylinder I.D. (mm/in.)



SLEEVE

REBUILD KIT
Sleeve • Piston
Gasket • T.E. Bearing

BORE SIZE (mm)

PISTON SIZE

TOP END

TOP END

VALVE TRAIN

BOTTOM END

PRO-X PISTON

WISECO PISTON

WOSSNER PISTON

VERTEX PISTON

JE PISTON

COMETIC GASKET

L.A. SLEEVE GASKET

CYLINDER AFTERMARKET KITS

VALVE / SPRING KIT

VALVE GUIDE

CAMSHAFT

CAM CHAIN

CRANKSHAFT

CON-ROD KIT

CRANK BEARING

ENGINE OIL SEAL KIT

BOTTOM END KIT
Crankshaft • Bearings • Seals • Gasket Set

KAWASAKI FOUR-STROKE (CONTINUED)

MODEL	Year	Configuration	Part No.	Bore (mm)	Stroke (mm)	Compression	Piston	Gasket	Top End	Valve Train	Bottom End
KL, KLR-650	1987-95	RS	KA-5009	100.00 101.00 102.00	Std. .040 .080		11:1 Comp. 8523DA 8523D100 8523D200				
KL, KLR-650	1996-18	RS	KA-5598	100.00 101.00 102.00	Std. .040 .080		11:1 Comp. (96-11) 8523DA 8523D100 8523D200				
				100.00 101.00 102.00	Std. .040 .080		(12-18) 4034DA 4034D100 4034D200				
KLR-650	2022-24	AC	KA-5838								
KLX-650R	1993-97	AC	KA-5226	100.00 101.00 102.00	Std. .040 .080		9.5:1 Comp. 8512DA 8512D100 8512D200		Top End C7246 (103mm)		
KLX-650	1993-96	RS	KA-5687	100.00 101.00 102.00	Std. .040 .080		9.5:1 Comp. 8512DA 8512D100 8512D200		Top End C7246 (103mm)		



GASGAS
HONDA
HUSQVARN
KAWASAKI
KTM
SUZUKI
YAMAHA
DIRT BIKE SLEEVES
STREET BIKE SLEEVES
ACCESSORIES
TECHNICAL



MODEL
Engine Description
Cylinder I.D. (mm/in.)

				TOP END					TOP END					BOTTOM END				
SLEEVE	REBUILD KIT <small>Sleeve - Piston Gasket - T.E. Bearing</small>	BORE SIZE (mm)	PISTON SIZE	PRO-X PISTON	WISECO PISTON	WOSSNER PISTON	VERTEX PISTON	T.E. BEARING	COMETIC GASKET	L.A. SLEEVE GASKET	CRANKSHAFT	CON-ROD KIT	CON-ROD ASSEMBLY <small>Rod - Bearings - Seals</small>	CRANK BEARING	CRANK SEAL KIT	BOTTOM END KIT <small>Crankshaft - Bearings - Seals - Gasket Set</small>		

KTM TWO-STROKE

KTM 50 (#2099) 39mm	1996 1.535"	CS	FL-5362							Top End C7282 (SX/SXR) C7415 (SXR PRO)			Hot Rods HR8149					
KTM 50 (FM20820M86) 49.8cc 39mm	1998-01 Reed 1.535"	AC	FL-5434 Not for Liquid Cooled	39.00 41.00	Std. .080		698M03900 698M04100			T.E. Bearing B1041	Top End C7282 (SX/SXR) C7415 (SXR PRO)	Complete with Oil Seals 37-1301	Hot Rods HR8149 (94-00)					
KTM 50 49cc 39.5mm	2002-07 1.555"	AC	FL-5549	39.50 41.50	Std. .080	6012A	803M03950 803M04150			T.E. Bearing B1041	Top End C7292	Complete with Oil Seals 37-1314						
KTM 50 SX 49cc 39.5mm	2002-08 Liquid Cooled 1.555"	AC	FL-5557	39.50 41.50	Std. .080	6012A	803M03950 803M04150	8225DA	VT22813CD	T.E. Bearing B1041	Top End C7295	Top End 35-0312 Complete with Oil Seals 37-6312	HR4420 (04-08)	Pro-X 03.6011 Hot Rods HR8135			Hot Rods CBK0202 (04-08)	
KTM 50 SX 49cc 39.5mm	2009-23 Liquid Cooled 1.555"	AC	FL-5746	39.50 41.50	Std. .080	6019A	874M03950 874M04150	8262DA	VT23429AB	T.E. Bearing B1041	Top End C3503	Top End 35-0337 Complete with Oil Seals 37-1337	HR4401	Pro-X 03.6011 Hot Rods HR8135			Hot Rods CBK0188 (09-12) CBK0190 (13-21)	
KTM 65 SX 63.5cc 45mm	1998-02 Liquid Cooled 1.772"	AC	FL-5393	5393K 45.00 47.00	Std. .080	6022A	746M04500 746M04700	8198DA	VT22481AB	T.E. Bearing B1042	Top End C7416 (98-01) C7333 (02)	Top End 35-6020 Complete with Oil Seals 37-6020	(00-02) Pro-X 04933 Hot Rods HR8625	39-6017 (00-02)	6304C3	096017		
KTM 65 SX/XC 64.8cc 45mm	2003-08 Liquid Cooled 1.772"	AC	FL-5550	5550K 45.00 47.00	Std. .080	6022A	746M04500 746M04700	8198DA	VT22481AB	T.E. Bearing B1042	Top End C7333	Top End 35-6020 Complete with Oil Seals 37-6020	HR4047	Pro-X 04911 Hot Rods HR8625	39-6017-1	6304C3	096017	Hot Rods CBK0085
KTM 65 SX 64.8cc 45mm	2009-23 Liquid Cooled 1.772"	AC	FL-5747	45.00 45.01	Std. Std.	6029A 6029B	864M04500	8241DA 8241DB	VT23430AB VT23430CD	T.E. Bearing B1042	Top End C3416	Top End 35-0338 Complete with Oil Seals 37-1338	HR4031	Pro-X 03.6029 Hot Rods HR8132	6304C3	096029	Hot Rods CBK0073 (09-21)	
KTM 85 SX/XC 85cc 47mm	2003-17 Liquid Cooled 1.850"	AC	FL-5551	5551K (03-12) 5551K-1 (13-17)	47.00 47.01	Std. Std.	6105A 6105B	8147DA 8147DB	VT24212A VT24212B	T.E. Bearing 01303	Top End C7384 (03-12) C3510 (13-17)	Top End 35-0315 (03-12) 35-0340 (13-17) Complete with Oil Seals 37-1315 (03-12) 37-1340 (13-17)	(03-12) HR4071 (13-17) HR4023	(03-12) Pro-X 03.6104 Hot Rods HR8724 (13-17) Pro-X 03.6113 Hot Rods HR8725	Left NJ205 Right 6304/22	096103	Hot Rods CBK0107 (03-12) CBK0187 (13-17)	

GASGAS
HONDA
HUSQVARNA
KAWASAKI
KTM
SUZUKI
YAMAHA
DIRT BIKE SLEEVES
STREET BIKE SLEEVES
ACCESSORIES
TECHNICAL





MODEL
Engine Description
Cylinder I.D. (mm/in.)

SLEEVE

REBUILD KIT
Sleeve - Piston
Gasket - T.E. Bearing

BORE SIZE (mm)

PISTON SIZE

TOP END

TOP END

BOTTOM END

PRO-X PISTON

WISECO PISTON

WOSSNER PISTON

VERTEX PISTON

T.E. BEARING

COMETIC GASKET

L.A. SLEEVE GASKET

CRANKSHAFT

CON-ROD KIT

CON-ROD ASSEMBLY
Rod - Bearings - Seals

CRANK BEARING

CRANK SEAL KIT

BOTTOM END KIT
Crankshaft - Bearings - Seals - Gasket Set

KTM TWO-STROKE (CONTINUED)

KTM 85 SX 85cc 47mm	2018-24 Liquid Cooled 1.850"	AC	FL-5796	5796K	47.00 47.01	Std. Std.	6105A 6105B	855M04700	8147DA 8147DB	VT24212A VT24212B		T.E. Bearing 01154	Top End C3636	Top End 35-6024 Complete with Oil Seals 37-0028 (18-21)	(18-21) HR00176	Pro-X 03.6113 Hot Rods HR8725	39-6113	Left NJ205 Right 6304/22 Bearing / Seal Kit 49-61003	096103		
KTM 105 SX/XC 105cc 52mm	2006-11 Liquid Cooled 2.047"	AC	FL-5552		52.00	Std.		855M05200	8224DA			T.E. Bearing 01303		Top End 35-0332 Complete with Oil Seals 37-1332	HR4071	Pro-X 03.6104 Hot Rods HR8724		Left NJ205 Right 6304/22	096103	Hot Rods CBK0108	
KTM 125 123cc 54.25mm	1987-92 Liquid Cooled 2.136"	AC MO	FL-5151		54.25 54.75	Std. .020			8011DA 8011D050			T.E. Bearing 01153		Top End 35-6214 (91-92)							
KTM 125 SX, E/XC 123cc 54.25mm	1993-94 Liquid Cooled 2.136"	AC	FL-5211		1993 54.25 1994 54.25 54.75	Std. Std. .020	6214C		1993 8011DA 1994 8029DA 8029D050			T.E. Bearing 01153	Top End C7097	Top End 35-6214							
KTM 125 SX, E/XC 123cc 54.25mm	1995-97 Liquid Cooled 2.136"	AC	FL-5264	5264K	54.25 54.75	Std. .020	6214C		8029DA 8029D050			T.E. Bearing 01153	Top End C7097 (95-96) C7456 (97)	Top End 35-6214							
KTM 125 SX, E/XC 124.8cc 54.25mm	1998 Liquid Cooled 2.136"	AC	FL-5388	5388K	54.25 54.75 56.25	Std. .020 .080	6219A	740M05425	8029DA 8029D050 8029D200			T.E. Bearing 01153	Top End C7456	Top End 35-6218		Pro-X 04997 Hot Rods HR8627	39-6218	Left NJ205 Right 6305JR2	096218		
<i>CYLINDER SLEEVING REQUIRED FOR OVERSIZES</i>																					
KTM 125 SX, E/XC 124.8cc 54.25mm	1999-00 Liquid Cooled 2.136"	AC	FL-5404	5404K	54.25 54.75 56.25	Std. .020 .080	6219A	740M05425	8029DA 8029D050 8029D200			T.E. Bearing 01153	Top End C7456	Top End 35-6218		Pro-X 04997 Hot Rods HR8627	39-6218	Left NJ206 Right 6305JR2	096218		
<i>CYLINDER SLEEVING REQUIRED FOR OVERSIZES</i>																					
KTM 125 SX, E/XC 124.8cc 54mm	2001-03 Liquid Cooled 2.126"	AC	FL-5457	5457K (01) 5457K-1 (02-03)	54.00 56.00 54.00	Std. .080 Std.	SINGLE RING (SX) 6221A	786M05400 786M05600	8056DA 8056D050			T.E. Bearing 01153	Top End C7456 (01) C7386 (02-03)	Top End 35-6218 (01) 35-6221 (02-03)	HR4024	Pro-X 04997 Hot Rods HR8627	39-6218	Left NJ206 Right 6305JR2	096218		
<i>CYLINDER SLEEVING REQUIRED FOR OVERSIZES</i>																					
KTM 125 SX 124.8cc 54mm	2004-06 Liquid Cooled 2.126"	AC	FL-5553	5553K	54.00 56.00	Std. .080	SINGLE RING (SX) 6221A	786M05400 786M05600	8056DA 8056D200			T.E. Bearing 01153	Top End C7386	Top End 35-6221 Complete with Oil Seals 37-6221	HR4024	Pro-X 04997 Hot Rods HR8627	39-6218	Left NJ206 Right 6305JR2	096218		
<i>CYLINDER SLEEVING REQUIRED FOR OVERSIZES</i>																					





MODEL
Engine Description
Cylinder I.D. (mm/in.)



SLEEVE

REBUILD KIT
Sleeve - Piston
Gasket - T.E. Bearing

BORE SIZE (mm)

PISTON SIZE

TOP END

TOP END

BOTTOM END

PRO-X PISTON

WISECO PISTON

WOSSNER PISTON

VERTEX PISTON

T.E. BEARING

COMETIC GASKET

L.A. SLEEVE GASKET

CRANKSHAFT

CON-ROD KIT

CON-ROD ASSEMBLY
Rod - Bearings - Seals

CRANK BEARING

CRANK SEAL KIT

BOTTOM END KIT
Crankshaft - Bearings - Seals - Gasket Set

KTM TWO-STROKE (CONTINUED)

MODEL	Engine Description	Cylinder I.D. (mm/in.)	SLEEVE	REBUILD KIT	BORE SIZE (mm)	PISTON SIZE	PRO-X PISTON	WISECO PISTON	WOSSNER PISTON	VERTEX PISTON	T.E. BEARING	COMETIC GASKET	L.A. SLEEVE GASKET	CRANKSHAFT	CON-ROD KIT	CON-ROD ASSEMBLY	CRANK BEARING	CRANK SEAL KIT	BOTTOM END KIT
KTM 125 SX 124.8cc 54mm	2007-15 Liquid Cooled 2.126"	AC	FL-5692	5692K	54.00 54.01 56.00	Std. Std. .080	6226A 6226B (2-Ring)	868M05400 (2-Ring)	8220DA 8220DB 8220D200 (Single Ring)	VT23928A VT23928B (2-Ring)	T.E. Bearing 01153	Top End C3211	Top End 35-0330 Complete with Oil Seals 37-1330	HR4024	Pro-X 04997 Hot Rods HR8670	39-6218	Left NJ206 Right 6305JR2	096218	Hot Rods CBK0004
KTM 125 SX 124.8cc 54mm	2016-22 Liquid Cooled 2.126"	AC	FL-5804	5804K	54.00 54.01 56.00	Std. Std. .080	6226A 6226B (Double Ring)	786M05400 (Single Ring)	8220DA 8220DB 8220D200 (Single Ring)	VT23928A VT23928B (Double Ring)	T.E. Bearing 01153	Top End C3606	Top End 35-6009	HR00177	Pro-X 03.6226 Hot Rods HR8174	39-6226	Left NJ206 Right 6305JR2	096218	Bearing / Seal Kit 49-62001
KTM 125 SX, XC 124.8cc 54mm	2023-24 Liquid Cooled 2.126"	AC	FL-5858		54.00 54.01 56.00	Std. Std. .080	6226A 6226B (Double Ring)	786M05400 (Single Ring)	8220DA 8220DB 8220D200 (Single Ring)	VT23928A VT23928B (Double Ring)	T.E. Bearing 01153	Top End C3808			Pro-X 3.6226		Left NJ206 Right 6305JR2	096218	Bearing / Seal Kit 49-62001
KTM 144 SX 144cc 56mm	2008 Liquid Cooled 2.204"	AC	FL-5684	5684K	56.00 56.01	Std. Std.	6228A 6228B	869M05600	8222DA 8222DB		T.E. Bearing 01153		Top End 35-0330 Complete with Oil Seals 37-1330	HR4025	Pro-X 04997 Hot Rods HR8670	39-6218	Left NJ206 Right 6305JR2	096218	Hot Rods CBK0063 (08-13) CBK0211 (14-15)
KTM 150 SX 150cc 58mm	2016-22 Liquid Cooled 2.283"	AC	FL-5805	5805K (18-22)	58.00 58.01	Std. Std.	6237A 6237B	881M05800	8311DA 8311DB	VT24101A VT24101B	T.E. Bearing 01153	Top End C3606 (18-22)	Top End 35-0370 (16-17) 35-6009 (18-22)	HR00177 (SX)	Pro-X 03.6226 Hot Rods HR8174	39-6226	Left NJ206 Right 6305JR2	096218	Bearing / Seal Kit 49-62001
KTM 150 XC-W TPI 150cc 58mm	2021-23 Liquid Cooled 2.283"	AC	FL-5805		58.00 58.01	Std. Std.	6241A 6241B	897M05800	8299DA 8299DB	VT24101A VT24101B	T.E. Bearing 01153	Top End C3606	Top End 35-6009		Pro-X 03.6226	39-6226	Left NJ206 Right 6305JR2	096218	Bearing / Seal Kit 49-62001
KTM 200 M/XC, E/XC 193cc 64mm	1998-02 Liquid Cooled 2.519"	AC	FL-5394	5394K	64.00 66.00	Std. .080	6248A	770M06400 770M06600	8048DA	VT22926A	T.E. Bearing 01202	Top End C7738	Top End 35-0308 Complete with Oil Seals 37-1308	HR4046	Pro-X 03.6248 Hot Rods HR8668	39-6248	Left NJ206 Right 6305JR2	096218	Hot Rods CBK0222
KTM 200 SX, M/XC, E/XC, XCW 193cc 64mm	2003-16 Liquid Cooled 2.519"	AC	FL-5554	5554K	64.00	Std.	6248A (E/XC, M/XC)	770M06400 (E/XC, M/XC)	8048DA (E/XC, M/XC)	VT22926A (E/XC, M/XC)	T.E. Bearing 01202	Top End C7942	Top End 35-0319 Complete with Oil Seals 37-1319 (06-12) 37-1371 (13-16)	HR4046 (XC-W)	Pro-X 03.6248 Hot Rods HR8668	39-6248	Left NJ206 Right 6305JR2	096218	Hot Rods CBK0084 (06-12) XCW CBK0217 (13-16) XCW



GASGAS
HONDA
HUSQVARNA
KAWASAKI
KTM
SUZUKI
YAMAHA
DIRT BIKE SLEEVES
STREET BIKE SLEEVES
ACCESSORIES
TECHNICAL



MODEL
Engine Description
Cylinder I.D. (mm/in.)



SLEEVE

REBUILD KIT
Sleeve - Piston
Gasket - T.E. Bearing

BORE SIZE (mm)

PISTON SIZE

TOP END

TOP END

BOTTOM END

PRO-X PISTON

WISECO PISTON

WOSSNER PISTON

VERTEX PISTON

T.E. BEARING

COMETIC GASKET

L.A. SLEEVE GASKET

CRANKSHAFT

CON-ROD KIT

CON-ROD ASSEMBLY
Rod - Bearings - Seals

CRANK BEARING

CRANK SEAL KIT

BOTTOM END KIT
Crankshaft - Bearings - Seals - Gasket Set

KTM TWO-STROKE (CONTINUED)

KTM 250 E/XC 249cc 67.5mm Liquid Cooled 2.657"	1990-92	AC	FL-5146	5146K	67.50 68.00 68.50	Std. .020 .040		601M06750 601M06800	8005DA 8005D050 8005D100			T.E. Bearing 01298	Top End C7098	Top End 35-6315 Complete with Oil Seals 37-6315	Pro-X 04949 Hot Rods HR8111			096320	
KTM 250 SX, EXC 249cc 67.5mm Liquid Cooled 2.657"	1993-94	AC	FL-5212	5212K	67.50 68.00 68.50	Std. .020 .040		601M06750 601M06800	8005DA 8005D050 8005D100			T.E. Bearing 01298	Top End C7098	Top End 35-6315 Complete with Oil Seals 37-6315	Pro-X 04949 Hot Rods HR8111			096320	
KTM 250 SX, EXC 249cc 67.5mm Liquid Cooled 2.657"	1995	AC	FL-5265		67.50	Std.		655M06750	8014DA			T.E. Bearing 01298	Top End C7098	Top End 35-6315 Complete with Oil Seals 37-6315	Pro-X 04949 Hot Rods HR8111			096320	
KTM 250 SX 249cc 67.5mm Liquid Cooled 2.657"	1996-97	AC	FL-5299	5299K	67.50 68.00 68.50	Std. .020 .040	6317A	694M06750	8016DA 8016D050 8016D100	VT22459B		T.E. Bearing 01298	Top End C7098	Top End 35-6315 Complete with Oil Seals 37-6315	Pro-X 04949 Hot Rods HR8111		Left NJ207R Right 6220C3	096320	
KTM 250 SX, E/XC, M/XC 249cc 67.5mm Liquid Cooled 2.657"	1998	AC	FL-5406	5406K	67.50 68.00 68.50	Std. .020 .040	6317A	694M06750	8016DA 8016D050 8016D100	VT22459B		T.E. Bearing 01298	Top End C7098	Top End 35-6315 Complete with Oil Seals 37-6315	Pro-X 04949 Hot Rods HR8111		Left NJ207R Right 6220C3	096320	
KTM 250 SX, E/XC, M/XC 249cc 67.5mm Liquid Cooled 2.657"	1999	AC	FL-5407	5407K	67.50 68.00 68.50	Std. .020 .040	6317A	694M06750	8016DA 8016D050 8016D100	VT22459B		T.E. Bearing 01298	Top End C7098	Top End 35-6315 Complete with Oil Seals 37-6315	Pro-X 04949 Hot Rods HR8111		Left NJ207R Right 6220C3	096320	
KTM 250 SX, E/XC, M/XC 249cc 66.4mm Liquid Cooled 2.614"	2000	AC	FL-5435	5435K (SX) 5435K-1 (E/XC, M/XC)	66.40 66.40	Std. Std.	SINGLE RING 6319A (SX) DOUBLE RING 6322A (XC)	SINGLE RING 774M6640 (SX) DOUBLE RING 857M06640 (XC)	SINGLE RING 8090DA (SX) DOUBLE RING 8081DA (XC)	SINGLE RING VT22649B (SX) DOUBLE RING VT22650B (XC)		T.E. Bearing 01298	Top End C7690	Top End 35-6316 Complete with Oil Seals 37-6316	Pro-X 04998		Left NJ207R Right 6220C3	096320	
KTM 250 SX, E/XC, M/XC 249cc 66.4mm Liquid Cooled 2.614"	2001	AC	FL-5458	5458K (SX) 5458K-1 (E/XC, M/XC)	66.40 66.40	Std. Std.	SINGLE RING 6319A (SX) DOUBLE RING 6322A (XC)	SINGLE RING 774M6640 (SX) DOUBLE RING 857M06640 (XC)	SINGLE RING 8090DA (SX) DOUBLE RING 8081DA (XC)	SINGLE RING VT22649B (SX) DOUBLE RING VT22650B (XC)		T.E. Bearing 01298	Top End C7690	Top End 35-6316 Complete with Oil Seals 37-6316	Pro-X 04998		Left NJ207R Right 6220C3	096320	
KTM 250 SX 249cc 66.4mm Liquid Cooled 2.614"	2002	AC	FL-5478	5478K (SX) 5478K-1 (E/XC, M/XC)	66.40 66.40	Std. Std.	SINGLE RING 6319A (SX) DOUBLE RING 6322A (XC)	SINGLE RING 774M6640 (SX) DOUBLE RING 857M06640 (XC)	SINGLE RING 8090DA (SX) DOUBLE RING 8081DA (XC)	SINGLE RING VT22649B (SX) DOUBLE RING VT22650B (XC)		T.E. Bearing 01298	Top End C7690	Top End 35-6316 Complete with Oil Seals 37-6316	Pro-X 04998		Left NJ207R Right 6220C3	096320	

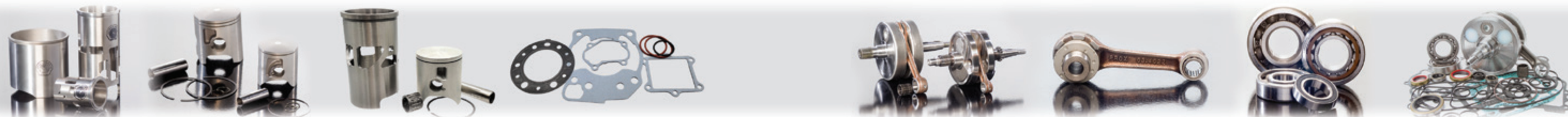

GASGAS
HONDA
HUSQVARNA
KAWASAKI
KTM
SUZUKI
YAMAHA
DIRT BIKE SLEEVES
STREET BIKE SLEEVES
ACCESSORIES
TECHNICAL



MODEL
Engine Description
Cylinder I.D. (mm/in.)



SLEEVE

REBUILD KIT
Sleeve - Piston
Gasket - T.E. Bearing

BORE SIZE (mm)

PISTON SIZE

TOP END

TOP END

BOTTOM END

PRO-X PISTON

WISECO PISTON

WOSSNER PISTON

VERTEX PISTON

T.E. BEARING

COMETIC GASKET

L.A. SLEEVE GASKET

CRANKSHAFT

CON-ROD KIT

CON-ROD ASSEMBLY
Rod - Bearings - Seals

CRANK BEARING

CRANK SEAL KIT

BOTTOM END KIT
Crankshaft - Bearings - Seals - Gasket Set

KTM TWO-STROKE (CONTINUED)

MODEL	Engine Description	Cylinder I.D. (mm/in.)	SLEEVE	REBUILD KIT	BORE SIZE (mm)	PISTON SIZE	PRO-X PISTON	WISECO PISTON	WOSSNER PISTON	VERTEX PISTON	T.E. BEARING	COMETIC GASKET	L.A. SLEEVE GASKET	CRANKSHAFT	CON-ROD KIT	CON-ROD ASSEMBLY	CRANK BEARING	CRANK SEAL KIT	BOTTOM END KIT	
KTM 250 SX KTM 250 M/XC, E/XC	2003-04 2004 249cc Liquid Cooled 66.4mm 2.614"	AC	FL-5555	5555K (SX) 5555K-1 (E/XC, M/XC)	66.40 66.41 66.40	Std. Std. Std.	SINGLE RING 6343A 6343B (SX) DOUBLE RING 6322A (XC)	SINGLE RING 856M06640 (SX) DOUBLE RING 857M06640 (EXC)	SINGLE RING 8082DB (SX) DOUBLE RING 8081DA (EXC)	SINGLE RING VT22909B (SX) DOUBLE RING VT22650B (EXC)	T.E. Bearing 01298	Top End C7943 (SX) C7417 (E/XC, M/XC)	Top End 35-0323 Complete with Oil Seals 37-6323	HR4026 (SX)	Pro-X 04923 Hot Rods HR 8669		Left NJ207R Right 6220C3 (03) Right 6232X2 (04)	096320	Hot Rods CBK0064 (SX)	
KTM 250 SX KTM 250 E/XC, XC-W	2005-06 2005-06 249cc Liquid Cooled 66.4mm 2.614"	AC	FL-5600	5600K (SX) 5600K-1 (E/XC, M/XC)	66.40 66.41 66.40	Std. Std. Std.	SINGLE RING 6343A 6343B (SX) DOUBLE RING 6322A (EXC '05)	SINGLE RING 856M06640 (SX) DOUBLE RING 857M06640 (EXC)	DOUBLE RING 8169DA 8169DB (SX)	DOUBLE RING VT23630A VT23630B	T.E. Bearing 01298	Top End C7943 (SX) C7417 (E/XC, M/XC)	Top End 35-0324 Complete with Oil Seals 37-1324	HR4026 (SX) HR4028 (XC, XC-W)	Pro-X 04923 Hot Rods HR 8669		Left NJ207R Right 6232X2	096320	Hot Rods CBK0005 (SX)	
KTM 250 SX KTM 250 XC KTM 250 XC-W	2007-10 2007-11 2007-10 249cc Liquid Cooled 66.4mm 2.614"	AC	FL-5693	5693K	66.40 66.41 68.50	Std. Std. .083	6343A 6343B	856M06640 856M06850	8169DA 8169DB	VT23630A VT23630B	T.E. Bearing 01298	Top End C3222	Top End 35-0333 Complete with Oil Seals 37-1333 (SX) 37-1344 (XC, XC-W)	HR4026 (SX) HR4028 (XC, XC-W)	Pro-X 04923 Hot Rods HR-8669		Left NJ207R Right 6232X2	096320	Hot Rods CBK0006 (SX) CBK0010 (XC, XCW)	
KTM 250 SX KTM 250 XC KTM 250 XC-W	2011-16 2012-14 2011-16 249cc Liquid Cooled 66.4mm 2.614"	AC	FL-5748	5748K	66.40 66.41 68.50	Std. Std. .083	6343A 6343B	856M06640 856M06850	8169DA 8169DB	VT23630A VT23630B	T.E. Bearing 01298	Top End C3222	Top End 35-0333 Complete with Oil Seals 37-1333 (SX) 37-1344 (XC, XC-W)	HR4026 (SX) HR4028 (XC, XC-W)	Pro-X 04923 Hot Rods HR-8669		Left NJ207R Right 6232X2	096320	Hot Rods CBK0006 (SX) CBK0010 (XC, XCW)	
KTM 250 SX KTM 250 XC-W KTM 250 XC KTM 250 XC-W TPI	2017-18 2017-18 2018 2019 249cc Liquid Cooled 66.4mm 2.614"	AC	FL-5785	5785K	66.40 66.41 68.00 68.50	Std. Std. .063 .083	6343A 6343B	856M06640 856M06850	8169DA 8169DB	VT23630A VT23630B VT23630160	T.E. Bearing 01298	Top End C3623	Top End 35-0976 Complete with Oil Seals 37-1976	(XC, XC-W) HR00125	Pro-X 04923 Hot Rods HR-8669	39-4923	Left NJ207R Right 6232X2	Bearing / Seal Kit 49-63004	096320	
KTM 250 SX KTM 250 XC TPI KTM 250 XC-W TPI	2019-22 2019-22 2020-23 249cc Liquid Cooled 66.4mm 2.614"	AC	FL-5811	5811K	66.40 66.41 68.00 68.50	Std. Std. .063 .083	6343A 6343B	856M06640 856M06850	8169DA 8169DB	VT23630A VT23630B VT23630160	T.E. Bearing 01298	Top End C3623	Top End 35-0976 Complete with Oil Seals 37-1976	(XC, XC-W) HR00125	Pro-X 04923 Hot Rods HR-8669	39-4923	Left NJ207R Right 6232X2	Bearing / Seal Kit 49-63004	096320	
KTM 250 SX KTM 250 XC KTM 250 XC-W	2023-24 2023-24 2024 249cc Liquid Cooled 66.4mm 2.614"	AC	FL-5859		66.40 66.41	Std. Std.	6343A 6343B	856M06640	8169DA 8169DB	VT23630A VT23630B	T.E. Bearing 01298	Top End C3811	Top End 35-6072	HR00125	Pro-X 04923	39-4923	Left NJ207R Right 6232X2	Bearing / Seal Kit 49-63004	096320	

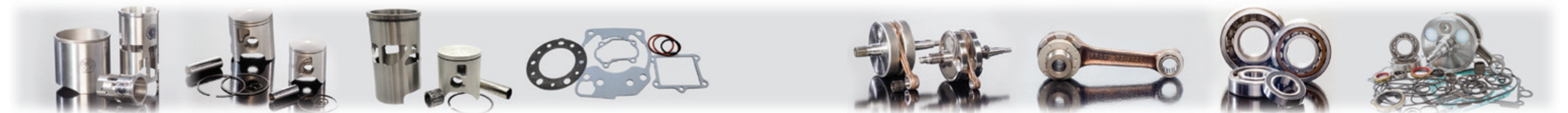

GASGAS
HONDA
HUSQVARNA
KAWASAKI
KTM
SUZUKI
YAMAHA
DIRT BIKE SLEEVES
STREET BIKE SLEEVES
ACCESSORIES
TECHNICAL



MODEL
Engine Description
Cylinder I.D. (mm/in.)



SLEEVE

REBUILD KIT
Sleeve - Piston
Gasket - T.E. Bearing

BORE SIZE (mm)

PISTON SIZE

TOP END

TOP END

BOTTOM END

PRO-X PISTON

WISECO PISTON

WOSSNER PISTON

VERTEX PISTON

T.E. BEARING

COMETIC GASKET

L.A. SLEEVE GASKET

CRANKSHAFT

CON-ROD KIT

CON-ROD ASSEMBLY
Rod - Bearings - Seals

CRANK BEARING

CRANK SEAL KIT

BOTTOM END KIT
Crankshaft - Bearings - Seals - Gasket Set

KTM TWO-STROKE (CONTINUED)

KTM 300 297cc Liquid Cooled 72mm 2.834" CYLINDER SLEEVING REQUIRED FOR OVERSIZES	1990-94	AC	FL-5147	5147K (91-94)	72.00 72.50 73.00	Std. .020 .040		631M07200 631M07300 (91-94)	8012DA 8012D050 8012D100 (91-94)			T.E. Bearing 01298	Top End C7099	Top End 35-0306 with Oil Seals 37-1306		Pro-X 04949 Hot Rods HR8111		096320		
KTM 300 E/XC, M/XC 297cc Liquid Cooled 72mm 2.834" CYLINDER SLEEVING REQUIRED FOR OVERSIZES	1995	AC	FL-5266		72.00 72.01	Std. Std.			8042DA 8042DB			T.E. Bearing 01298	Top End C7099	Top End 35-0306 Complete with Oil Seals 37-1306		Pro-X 04949 Hot Rods HR8111		096320		
KTM 300 E/XC, M/XC 297cc Liquid Cooled 72mm 2.834" CYLINDER SLEEVING REQUIRED FOR OVERSIZES	1996	AC	FL-5315	5315K	72.00 72.50 73.00	Std. .020 .040	01.6396A	712M07200	8017DA 8017D050 8017D100			T.E. Bearing 01298	Top End C7099	Top End 35-0306 Complete with Oil Seals 37-1306		Pro-X 04949 Hot Rods HR8111		096320		
KTM 300 E/XC, M/XC 297cc Liquid Cooled 72mm 2.834" CYLINDER SLEEVING REQUIRED FOR OVERSIZES	1997-98	AC	FL-5408	5408K	72.00 72.50 73.00	Std. .020 .040	01.6396A	712M07200	8017DA 8017D050 8017D100			T.E. Bearing 01298	Top End C7099	Top End 35-0306 Complete with Oil Seals 37-1306		Pro-X 04949 Hot Rods HR8111		Left NJ207R Right 6220C3	096320	
KTM 300 E/XC, M/XC 297cc Liquid Cooled 72mm 2.834" CYLINDER SLEEVING REQUIRED FOR OVERSIZES	1999-01	AC	FL-5410	5410K (99) 5410K-1 (00-01)	72.00 72.50 73.00	Std. .020 .040	01.6396A	712M07200	8017DA 8017D050 8017D100			T.E. Bearing 01298	Top End C7099 (99) C7816 (00-01)	Top End 35-0306 Complete with Oil Seals 37-1306		Pro-X 04949 Hot Rods HR8111		Left NJ207R Right 6220C3	096320	
KTM 300 E/XC, M/XC 297cc Liquid Cooled 72mm 2.834" (Cyl #54630405200) CYLINDER SLEEVING REQUIRED FOR OVERSIZES	2002-03	AC	FL-5521	5521K	72.00 72.50 73.00	Std. .020 .040	01.6396A	712M07200	8017DA 8017D050 8017D100			T.E. Bearing 01298	Top End C7816	Top End 35-0306 Complete with Oil Seals 37-1306		Pro-X 04949 Hot Rods HR8111		Left NJ207R Right 6220C3	096320	
KTM 300 E/XC, M/XC KTM 300 XC-W 297cc Liquid Cooled 72mm 2.834" (Cyl #54830305000R) CYLINDER SLEEVING REQUIRED FOR OVERSIZES	2004-05 2006-07	AC	FL-5632		72.00 72.01	Std. Std.	01.6394A 01.6394B	858M07200	8219DA 8219DB	VT23375A VT23375B		T.E. Bearing 01298	Top End C7423	Complete with Oil Seals 37-1326 (05-07)	HR4028	Pro-X 04923 Hot Rods HR8669		Left NJ207R Right 6232X2	096320	Hot Rods CBK0008 (05-07)
KTM 300 XC-W, XC 297cc Liquid Cooled 72mm 2.834" CYLINDER SLEEVING REQUIRED FOR OVERSIZES	2008-11	AC	FL-5694		72.00 72.01	Std. Std.	01.6394A 01.6394B	858M07200	8250DA 8250DB	VT23375A VT23375B		T.E. Bearing 01298		Top End 35-0335 Complete with Oil Seals 37-1335	HR4028	Pro-X 04923 Hot Rods HR8669		Left NJ207R Right 6232X2	096320	Hot Rods CBK0011



GASGAS
HONDA
HUSQVARNA
KAWASAKI
KTM
SUZUKI
YAMAHA
DIRT BIKE SLEEVES
STREET BIKE SLEEVES
ACCESSORIES
TECHNICAL



MODEL
Engine Description
Cylinder I.D. (mm/in.)



SLEEVE

REBUILD KIT
Sleeve - Piston
Gasket - T.E. Bearing

BORE SIZE (mm)

PISTON SIZE

TOP END

TOP END

BOTTOM END

PRO-X PISTON

WISECO PISTON

WOSSNER PISTON

VERTEX PISTON

T.E. BEARING

COMETIC GASKET

L.A. SLEEVE GASKET

CRANKSHAFT

CON-ROD KIT

CON-ROD ASSEMBLY
Rod - Bearings - Seals

CRANK BEARING

CRANK SEAL KIT

BOTTOM END KIT
Crankshaft - Bearings - Seals - Gasket Set

KTM TWO-STROKE (CONTINUED)

MODEL	Engine Description	Cylinder I.D. (mm/in.)	SLEEVE	REBUILD KIT	BORE SIZE (mm)	PISTON SIZE	PRO-X PISTON	WISECO PISTON	WOSSNER PISTON	VERTEX PISTON	T.E. BEARING	COMETIC GASKET	L.A. SLEEVE GASKET	CRANKSHAFT	CON-ROD KIT	CON-ROD ASSEMBLY	CRANK BEARING	CRANK SEAL KIT	BOTTOM END KIT	
KTM 300 XC-W, XC 297cc 72mm	Liquid Cooled 2.834"	AC	FL-5749		72.00 72.01	Std. Std.	01.6394A 01.6394B	858M07200	8250DA 8250DB	VT23375A VT23375B	T.E. Bearing 01298		Top End 35-0335 Complete with Oil Seals 37-1335	HR4028	Pro-X 04923 Hot Rods HR8669			Left NJ207R Right 6232X2	096320	Hot Rods CBK0011
KTM 300 XC, EXC KTM 300 XC-W KTM 300 XC-W TPI	2017-18 2017-18 2019 297cc 72mm	Liquid Cooled 2.834"	AC	FL-5798	5798K	72.00 72.01	Std. Std.	01.6387A 01.6387B	882M07200	8301DA 8301DB	VT23375A VT23375B	T.E. Bearing 01298	Top End C3623	Top End 35-0976 Complete with Oil Seals 37-1976	Pro-X 04923 Hot Rods HR-8669	39-4923		Left NJ207R Right 6232X2 Bearing / Seal Kit 49-63004	096320	Hot Rods CBK00178
KTM 300 XC TPI KTM300 XC-W TPI	2020-22 2020-23 297cc 72mm	Liquid Cooled 2.834"	AC	FL-5815	5815K	72.00 72.01	Std. Std.	01.6388A 01.6388B	883M07200	8304DA 8304DB	VT24244A VT24244B	T.E. Bearing 01298	Top End C3623	Top End 35-0976 Complete with Oil Seals 37-1976	Pro-X 04923 Hot Rods HR-8669	39-4923		Left NJ207R Right 6232X2 Bearing / Seal Kit 49-63004	096320	Hot Rods (Thru-2021) CBK00178
KTM 300 SX KTM 300 XC KTM 300 XC-W	2023-24 2023-24 2024 297cc 72mm	Liquid Cooled 2.834"	AC	FL-5860		72.00 72.01	Std. Std.	01.6388A 01.6388B	883M07200	8304DA 8304DB	VT24244A VT24244B	T.E. Bearing 01298	Top End 35-6072	HR00125	Pro-X 04923 Hot Rods HR-8669	39-4923		Left NJ207R Right 6232X2 Bearing / Seal Kit 49-63004	096320	
KTM 360 SX, E/XC	1996 353cc 78mm	Liquid Cooled 3.071"	AC	FL-5411		78.00	Std.	01.6397A		8083DA		T.E. Bearing 01298	Top End C7285	Top End 35-0307					096320	
KTM 360 SX, E/XC	1997-99 353cc 78mm	Liquid Cooled 3.071"	AC	FL-5363		78.00 78.50 79.00	Std. .020 .040	01.6397A	747M07800	8083DA 8083D050 8083D100		T.E. Bearing 01298	Top End C7285	Top End 35-0307					096320	
KTM 380 SX, E/XC, M/XC	1998-02 368cc 78mm	Liquid Cooled 3.071"	AC	FL-5412		78.00 79.00	Std. .040	01.6398A	748M07800 748M07900	8223DA 8223D100		T.E. Bearing 01298	Top End C7285	Top End 35-0307					096320	

CYLINDER SLEEVING
REQUIRED FOR OVERSIZES

MUST DRILL RELIEF HOLE
IN SLEEVE AFTER
INSTALLATION



GASGAS
HONDA
HUSQVARNA
KAWASAKI
KTM
SUZUKI
YAMAHA
DIRT BIKE SLEEVES
STREET BIKE SLEEVES
ACCESSORIES
TECHNICAL



MODEL
Engine Description
Cylinder I.D. (mm/in.)

SLEEVE	REBUILD KIT <small>Sleeve • Piston Gasket • T.E. Bearing</small>	BORE SIZE (mm)	PISTON SIZE	TOP END						TOP END		VALVE TRAIN				BOTTOM END				
				PRO-X PISTON	WISECO PISTON	WOSSNER PISTON	VERTEX PISTON	JE PISTON	COMETIC GASKET	L.A. SLEEVE GASKET	CYLINDER AFTERMARKET KITS	VALVE / SPRING KIT	VALVE GUIDE	CAMSHAFT	CAM CHAIN	CRANKSHAFT	CON-ROD KIT	CRANK BEARING	ENGINE OIL SEAL KIT	BOTTOM END KIT <small>Crankshaft • Bearings • Seals • Gasket Set</small>

KTM FOUR-STROKE

KTM 250 E/XC Racing 2001-06 249cc Liquid Cooled 75mm 2.952"	AC	FL-5558		75.00 75.01	Std. Std.			12:1 Comp. 8592DA 8592DB			Top End C7169		Top End 35-0316							Pro-X 04925	NJ206ECP-1			
KTM 250 SX-F 2005-09 KTM 250 EXC-F 2007-09 KTM 250 XC-F, XCF-W 2007-09 249cc Liquid Cooled 76mm 2.992" <i>RESLEEVEING REQUIRED FOR OVERSIZES</i> <i>CYL. WORKS COMPLETE KIT INCLUDES CYLINDER, PISTON, TOP END GASKETS</i>	AC	FL-5604	5604K	76.00 76.01 78.00 80.00	Std. Std. .080 .120	12.8:1 Comp. 6338A 6338B	12.8:1 Comp. 4981M07600	12.9:1 Comp. 8645DA 8645DB 8645D400	12.8:1 Comp. VT23235A VT23235B	13:1 Comp. 247623	Top End C3164-EST C3184-EST (79mm)		Top End 35-0328	Cylinder Works 50002 Complete Kit 50002-K01 (Std. 76mm)	Titanium Exhaust 28-63261 Titanium Intake 28-63262 Steel Exhaust 96-96106 (05-07) 96-96266 (08-12) Steel Intake 96-96102 (05-07) 96-96262 (08-12) Valve Spring Kit 96-96090 (05-07) 96-96250 (08-12)			CC-6328	HR4029 (SX-F) HR4408 (EXC-F, XC-F, XCF-W)	Pro-X 03.6326 (SX-F, EXC-F) Hot Rods HR8667	NJ206 49K067 (SX-F) 49K069 (EXC-F) 49K069 (XC-F) 49K069 (XCF-W)	49-822320		
KTM 250 SX-F 2010-12 KTM 250 EXC-F, XC-F 2010-12 KTM 250 XCF-W 2010-13 249cc Liquid Cooled 76mm 2.992" <i>RESLEEVEING REQUIRED FOR OVERSIZES</i> <i>CYL. WORKS COMPLETE KIT INCLUDES CYLINDER, PISTON, TOP END GASKETS</i>	AC	FL-5682	5682K	76.00 76.01 78.00 80.00	Std. Std. .080 .120	12.8:1 Comp. 6338A 6338B	12.8:1 Comp. 4981M07600	12.9:1 Comp. 8645DA 8645DB 8645D400	12.8:1 Comp. VT23235A VT23235B	13:1 Comp. 247623	Top End C3164-EST C3184-EST (79mm)		Top End 35-0328	Cylinder Works 50002 Complete Kit 50002-K01 (Std. 76mm)	Titanium Exhaust 28-63261 Titanium Intake 28-63262 Steel Exhaust 96-96266 Steel Intake 96-96262 Valve Spring Kit 96-96250		SX-F, XC-F Hot Cams (2011-12) Stage 1 (Intake) 3225-1IN (Exhaust) 3226-1E Stage 2 (Intake) 3227-2IN (Exhaust) 3228-2E	(09-12) CC-6328	SX-F (10) HR4029 SX-F (11-12) HR4039 XC-F (10) XCF-W (10) HR4408 XC-F (11-12) XCF-W (12-13) HR4039	Pro-X 03.6326 Hot Rods HR8667 Wossner WR4003	NJ206 49K067 SX-F (10) 49K068 SX-F (11) 49K076 SX-F (12) 49K069 XC-F (10) 49K068 XC-F (11-12) 49K069 XCF-W (10-11) 49K068 XCF-W (12) 49K076 XCF-W (13)	49-822320		
KTM 250 SX-F, Big Bore to 280cc 2005-12 80mm 3.150" <i>CYL. WORKS COMPLETE KIT INCLUDES CYLINDER, PISTON, TOP END GASKETS</i>	BB	FL-5682B		80.00 80.00	.160				13.3:1 Comp. VT23274A	12.5:1 Comp. J5604PS	Top End GS5604			Cylinder Works Complete Kit 51002-K01 (276cc 80mm)										
KTM 250 SX-F, XC-F 2013-15 XCF-W 2014-16 250cc Liquid-Cooled 78mm 3.071" <i>CYL. WORKS COMPLETE KIT INCLUDES CYLINDER, PISTON, TOP END GASKETS</i>	AC	FL-5743		78.00 78.01	Std. Std.	13.9:1 Comp. 6333A 6333B	13.9:1 Comp. 40074M07800	13.9:1 Comp. 8865DA 8865DB	13.9:1 Comp. VT23757A VT23757B	13.5:1 Comp. 323895	Top End C3511		Top End 35-0364	Cylinder Works 50004 Complete Kit 50004-K01 (Std. 78mm)	Titanium Exhaust 28-63331 Titanium Intake 28-63332 Valve Spring Kit 96-96400	Valve Guide Exhaust 96-96430 Intake 96-96420 Valve Seals Pkg. of 4 71041-4	Hot Cams Stage 1 (Intake) 3282-1IN (Exhaust) 3283-1E	CC-6351	HR4402	Pro-X 03.6333 Hot Rods HR8701 Wossner WR4059	NJ206ECP-3 49K085	49-822364	Hot Rods (13, SX-F) CBK0199 (14-15, SX-F) CBK0210	
KTM 250 SX-F, XC-F 2016-22 250cc Liquid-Cooled 78mm 3.071"	AC	FL-5743		78.00 78.01	Std. Std.	14.4:1 Comp. 6347A 6347B	14.4:1 Comp. 40144M07800	14.4:1 Comp. 8923DA 8923DB	14.4:1 Comp. VT24097A VT24097B	14.5:1 Comp. 366506	Top End C3595-EST		Top End 35-0372	Cylinder Works 50006 Complete Kit 50006-K01 (Std. 78mm)	Titanium Exhaust 28-63331 Titanium Intake 28-63332		Hot Cams Stage 1 (Intake) 3306-1IN (Exhaust) 3307-E	CC-6356		Pro-X 03.6337 Wossner WR4067	NJ206ECP-3 49-63016 (16-18) 49-63017 (19-22)	49-822372		

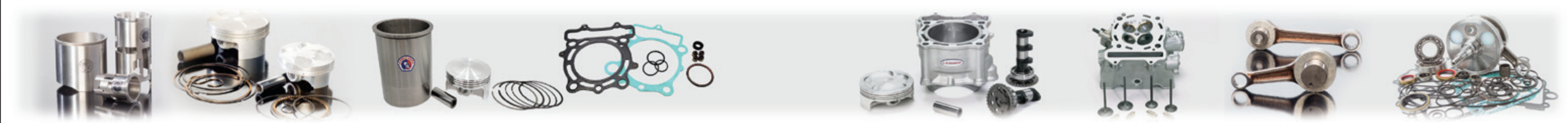

GASGAS HONDA HUSQVARNA KAWASAKI KTM SUZUKI YAMAHA DIRT BIKE SLEEVES STREET BIKE SLEEVES ACCESSORIES TECHNICAL



MODEL
Engine Description
Cylinder I.D. (mm/in.)



SLEEVE	REBUILD KIT <small>Sleeve • Piston Gasket • T.E. Bearing</small>	BORE SIZE <small>(mm)</small>	PISTON SIZE	TOP END							TOP END		VALVE TRAIN				BOTTOM END				
				PRO-X PISTON	WISECO PISTON	WOSSNER PISTON	VERTEX PISTON	JE PISTON	COMETIC GASKET	L.A. SLEEVE GASKET	CYLINDER AFTERMARKET KITS	VALVE / SPRING KIT	VALVE GUIDE	CAMSHAFT	CAM CHAIN	CRANKSHAFT	CON-ROD KIT	CRANK BEARING	ENGINE OIL SEAL KIT	BOTTOM END KIT <small>Crankshaft • Bearings • Seals • Gasket Set</small>	

KTM FOUR-STROKE (CONTINUED)

KTM 250 EXC-F 2017-23 250cc Liquid-Cooled 78mm 3.071"	AC	FL-5743		78.00 78.01	Std. Std.	13.9:1 Comp. 6333A 6333B	13.9:1 Comp. 40074M07800	13.9:1 Comp. 8865DA 8865DB	12.8:1 Comp. VT24196A VT24196B				Top End (17-19) 35-0372		Titanium Exhaust 28-63331 Titanium Intake 28-63332			CC-6356		Pro-X 03.6337	NJ206ECP-3 Bearing / Seal Kit 49K092 (18-21)	
KTM 250 SX-F 2023-24 250cc Liquid-Cooled 81mm 3.189"	AC	FL-5854		81.00 81.01	Std. Std.	14.5:1 Comp. 6348A 6348B		14.4:1 Comp. 4077DA 4077DB			Top End C3809		Top End 35-6343					CC-6356		Pro-X 03.6343	NJ206ECP-3 Bearing / Seal Kit 49-63017	
KTM 350 SX-F, XC-F 2011-12 350cc Single Liquid-Cooled 88mm 3.464" <i>CYL. WORKS COMPLETE KIT INCLUDES CYLINDER, PISTON, TOP END GASKETS</i>	AC	FL-5734		88.00 88.01	Std. Std.	13.5:1 Comp. 6353A 6353B	14.5:1 Comp. 40015M08800	13.5:1 Comp. 8870DA 8870DB	13.5:1 Comp. VT23641A VT23641B	13.5:1 Comp. 300267	Top End C3249	Top End SX-F, XCF 35-0339 Complete w/ oil seals 37-1339	Cylinder Works 50001 Complete Kit 50001-K01 (Std., 88mm)	Titanium Exhaust 28-63511 Titanium Intake 28-63512		Hot Cams Intake (Stage 1) 3290-11N		CC-6351		Pro-X 03.6351 Hot Rods HR8693 Wossner WR4040	NJ206ECP-3 Bearing / Seal Kit 49-822356 49-63013	
KTM 350 SX-F, XC-F 2013-23 350cc Single Liquid-Cooled 88mm 3.464" <i>CYL. WORKS COMPLETE KIT INCLUDES CYLINDER, PISTON, TOP END GASKETS</i>	AC	FL-5745		88.00 88.01	Std. Std.	(13-15) 13.5:1 Comp. 6353A 6353B	(13-23) 14.5:1 Comp. 40015M08800	(13-23) 13.5:1 Comp. 8870DA 8870DB	(13-15) 13.6:1 Comp. VT23831A VT23831B	(13-22) 13.5:1 comp. 300267	Top End (13-14) C3519	Top End (13-15) 35-0339 (16-18) 35-0373 (19-22) 35-0035	Cylinder Works (13-15) 50003 Complete Kit 50003-K01 (Std., 88mm) (16-18) 50007 Complete Kit 50007-K01 (Std., 88mm) (19-22) 50008 Complete Kit 50008-K01 (Std., 88mm)	Titanium Exhaust (13-22) 28-63511 (*23) 28-63531 Titanium Intake (13-22) 28-63512 (*23) 28-63532		Hot Cams (13-15) Intake (Stage 1) 3290-11N	(13-15) CC-6351 (16-22) CC-6356 (*23) CC-6363	Pro-X (13-15) 03.6363 (16-23) 03.6366 Hot Rods (13-15) HR8702	NJ206ECP-3 (13-15) 49-822364 (16-22) 49-822372 Pro-X Bearing / Seal Kit 49-63013 (13-15) 49-63016 (16-18) 49-63017 (19-23) Hot Rods Bearing / Seal Kit 49-K085 (13-15) 49-K092 (16-20)			
KTM 350 EXC-F 2012-16 KTM 350 XCF-W 2012-16 350cc Single Liquid-Cooled 88mm 3.464"	AC	FL-5734		88.00 88.01	Std. Std.	12.3:1 Comp. 6362A 6362B	12.3:1 Comp. 40056M08800	12.3:1 Comp. 8885DA 8885DB	12.3:1 Comp. VT23711A VT23711B			Top End 35-0339						CC-6351		Pro-X (12-13) 03.6351 (14-16) 03.6363	NJ206ECP-3 (EXC-F) 49-822356 Pro-X Bearing / Seal Kit 49-63013 (12-15) 49-63017 (16-23)	
KTM 350 EXC-F 2017-23 350cc Single Liquid-Cooled 88mm 3.464" <i>CYL. WORKS COMPLETE KIT INCLUDES CYLINDER, PISTON, TOP END GASKETS</i>	AC	FL-5745		88.00 88.01	Std. Std.	(17-19) 12.3:1 Comp. 6367A 6367B	(17-19) 12.3:1 Comp. 40166M08800	(17-19) 12.5:1 Comp. 8941DA 8941DB	(17-19) 12.3:1 Comp. VT24213A VT24213B		Top End (20-23) C3790	Top End (17-19) 35-0373 (20-22) 35-0035	(17-19) Cylinder Works Complete Kit 50007-K02 (Std., 88mm) (20-22) Complete Kit 50008-K01 (Std., 88mm)	Titanium Exhaust (12-19) 28-63511 Steel Exhaust (20-23) 28-63621 Titanium Intake (12-19) 28-65512 Steel Intake (20-23) 28-63622			CC-6356		Pro-X 03.6366	NJ206ECP-3 Bearing / Seal Kit 49-822372 49-63017		

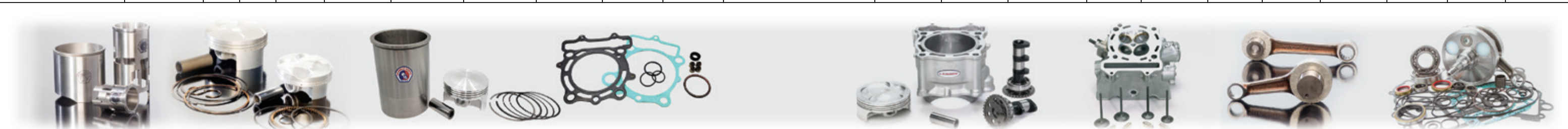

GASGAS
HONDA
HUSQVARNA
KAWASAKI
KTM
SUZUKI
YAMAHA
DIRT BIKE SLEEVES
STREET BIKE SLEEVES
ACCESSORIES
TECHNICAL



MODEL
Engine Description
Cylinder I.D. (mm/in.)



SLEEVE	REBUILD KIT <small>Sleeve • Piston Gasket • T.E. Bearing</small>	BORE SIZE (mm)	PISTON SIZE	TOP END							TOP END		VALVE TRAIN				BOTTOM END				
				PRO-X PISTON	WISECO PISTON	WOSSNER PISTON	VERTEX PISTON	JE PISTON	COMETIC GASKET	L.A. SLEEVE GASKET	CYLINDER AFTERMARKET KITS	VALVE / SPRING KIT	VALVE GUIDE	CAMSHAFT	CAM CHAIN	CRANKSHAFT	CON-ROD KIT	CRANK BEARING	ENGINE OIL SEAL KIT	BOTTOM END KIT <small>Crankshaft • Bearings • Seals • Gasket Set</small>	

KTM FOUR-STROKE (CONTINUED)

KTM 400 SX, E/XC, SXC, M/XC, XC-W 398cc Single Liquid Cooled 89mm 3.504"	2000-07	AC	FL-5436								Top End C7944-EST		Top End 35-0317													
KTM 400 EXC, XC-W 393cc Single Liquid-Cooled 95mm 3.740"	2009-11	AC	FL-5744		95.00 95.01	Std. Std.	11.1:1 Comp. 6439A 6439B				Top End C3241-EST			Steel Exhaust 28-64281 Titanium Intake 28-64282			CC-6428									
KTM 450 EXC, XC-W 448cc Single Liquid Cooled 89mm 3.504"	2003-07 2005-07	AC	FL-5442		89.00 89.01	Std. Std.	11:1 Comp. 6413A 6413B	11:1 Comp. 4941M08900	11:1 Comp. 8581DA 8581DB		Top End C7944-EST		Top End 35-0317 Complete w/ oil seals 37-1317		Steel Exhaust 28-65201 Steel Intake 28-65202					Pro-X 04925	NJ206ECP-1 Bearing / Seal Kit 49-64003					
KTM 450 SX, XC-W 449cc Single Liquid Cooled 95mm 3.740" <i>RESLEEVEING REQUIRED FOR OVERSIZES</i>	2003-06 2005-07	AC	FL-5556		95.00 97.00	Std. .080	12:1 Comp. 6424A 6428	12:1 Comp. 4805M09500	12:1 Comp. 8560DA		Top End C7944-EST (95mm) C7691 (97mm)		Top End 35-0318 Complete w/ oil seals 37-1318		Titanium Exhaust 28-64231 Titanium Intake 28-64232					Pro-X 03.6423	NJ206ECP-1 Bearing / Seal Kit 49-64003					
KTM 450 SX-F, XC-F 449cc Single Liquid Cooled 97mm 3.818"	2007-12 2008-09 2008-12	AC	FL-5638		97.00 97.01	Std. Std.	12.5:1 Comp. 6427A 6427B	12.2:1 Comp. 4937M09700	12.5:1 Comp. 8665DA 8665DB	12.5:1 Comp. VT23342A VT23342B	12.5:1 Comp. 260955	Top End C3412-EST	Top End 35-0331		Titanium Exhaust 28-64271 Titanium Intake 28-64272			CC-6427		Pro-X 03.6427 Wossner WR4017	NJ206ECP-2 Bearing / Seal Kit 49-64007	49-822333				
KTM 450 EXC-R, XC-W 449cc Single Liquid Cooled 95mm 3.740"	2008-11 2009-11	AC	FL-5556		95.00 95.01	Std. Std.	11.9:1 Comp. 6429A 6429B		11.9:1 Comp. 8707DA 8707DB	11.9:1 Comp. VT23379A VT23379B		Top End C3241-EST	Top End 35-0342 Complete w/ oil seals 37-1342		Steel Exhaust 28-64281 Titanium Intake 28-64282			CC-6428		Pro-X 03.6428 Wossner WR4057 Hot Rods HR8663	SX07E39 Bearing / Seal Kit 49-64012	49-822359				
KTM 450 XC-W, XC-W 449cc Single Liquid Cooled 95mm 3.740"	2012-16 2012-16	AC	FL-5744		95.00 95.01	Std. Std.	11.8:1 Comp. 6432A 6432B		11.8:1 Comp. 8898DA 8898DB	11.8:1 Comp. VT23859A VT23859B			Top End 35-0342 Complete w/ oil seals 37-1343		EXC (12-16) Steel Exhaust 28-64281 Titanium Intake (12-13) 28-64282 (14-16) 28-64332			CC-6428		Pro-X EXC 12-13 03.6432 EXC 14-16 03.6433 Wossner (14-16) WR4058	49-822360 Pro-X Bearing / Seal Kit EXC 49-64012 Hot Rods Bearing / Seal Kit XC-W 49K090					
KTM 450 EXC-F, XCF-W 449cc Single Liquid Cooled 95mm 3.740" <i>CYL. WORKS COMPLETE KIT INCLUDES CYLINDER, PISTON, TOP END GASKETS</i>	2017-24 2023-24	AC	FL-5744		95.00 95.01	Std. Std.	(17-19) 11.8:1 Comp. 6432A 6432B (20-23) 12.75:1 Comp. 6440A 6440B		(17-21) 11.8:1 Comp. 8898DA 8898DB (22-24) 12.75:1 Comp. 4070DA 4070DB	(17-24) 11.8:1 Comp. VT24209A VT24209B (17-24) 12.8:1 Comp. VT24211A VT24211B		Top End (17-19) 35-6417 (20-23) 35-6439	Cylinder Works (17-21) Complete Kit 50009-K02 (95mm Std.)	Steel Exhaust (17-19) 28-64281 (20-24) 28-64201 Titanium Intake (17-19) 28-64332 (20-24) 28-64192			(17-19) CC-6328 (20-24) CC1335		Pro-X 03.6346 Wossner HR4068	NJ207ECP-1 Pro-X Bearing / Seal Kit 49-64016 Hot Rods Bearing / Seal Kit 49K093						

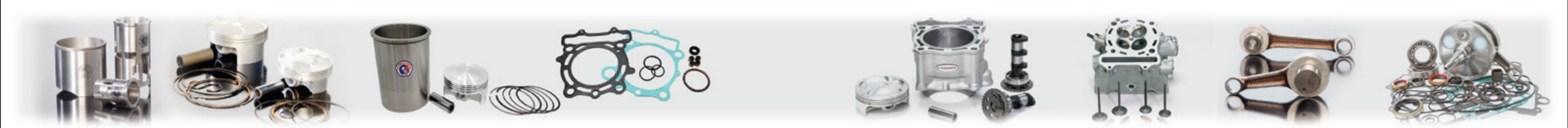

GASGAS
HONDA
HUSQVARNA
KAWASAKI
KTM
SUZUKI
YAMAHA
DIRT BIKE SLEEVES
STREET BIKE SLEEVES
ACCESSORIES
TECHNICAL



MODEL
Engine Description
Cylinder I.D. (mm/in.)



SLEEVE

REBUILD KIT
Sleeve • Piston
Gasket • T.E. Bearing

BORE SIZE (mm)

PISTON SIZE

TOP END

TOP END

VALVE TRAIN

BOTTOM END

PRO-X PISTON

WISECO PISTON

WOSSNER PISTON

VERTEX PISTON

JE PISTON

COMETIC GASKET

L.A. SLEEVE GASKET

CYLINDER AFTERMARKET KITS

VALVE / SPRING KIT

VALVE GUIDE

CAMSHAFT

CAM CHAIN

CRANKSHAFT

CON-ROD KIT

CRANK BEARING

ENGINE OIL SEAL KIT

BOTTOM END KIT
Crankshaft • Bearings • Seals • Gasket • Set

KTM FOUR-STROKE (CONTINUED)

KTM 450 SX-F 2013-22 KTM 450 XC-F 2013-22 449cc Single Liquid Cooled 95mm 3.740" <i>CYL. WORKS COMPLETE KIT INCLUDES CYLINDER, PISTON, TOP END GASKETS</i>	AC	FL-5744		95.00 95.01	Std. Std.	12.6:1 Comp. 6433A 6433B	12.75:1 Comp. 40297M09500	12.6:1 Comp. 8868DA 8868DB	12.6:1 Comp. VT24099A VT24099B		Top End (13-15) C3241-EST (16-23) C3604-EST	Top End (13-15) 35-0959 (16-22) 35-0374	Cylinder Works (16-22) 50009 Complete Kit 50009-K01 (95mm Std.)	Titanium Exhaust (13-18) 28-64331 (19-22) 28-64191 Titanium Intake (13-18) 28-64332 (19-22) 28-64192	Valve Guide (13-18) IN / EX 96-96520 O/S+001 96-96521 Valve Seals Pkg. of 4 71029-4	(13-15) CC-6428 (16-18) CC-6328 (19-22) CC-1335	Pro-X (13-15) 03.6433 (16-22) 03.6436 Hot Rods (13-15) HR8705 Wossner (16-22) HR4068	(13-15) SX07E39 49-822360 (16-22) NJ207ECP-1 49-822374 Pro-X Bearing / Seal Kit 49-64012 (13-15) 49-64016 (16-22) Hot Rods Bearing / Seal Kit 49K090 (13-15) 49K093 (16-21)	(13-15) 49-822360 (16-22) 49-822374	
	KTM 450 SX-F 2023-24 KTM 450 XC-F 2023-24 449cc Single Liquid Cooled 95mm 3.740" <i>CYL. WORKS COMPLETE KIT INCLUDES CYLINDER, PISTON, TOP END GASKETS</i>	AC	FL-5744		95.00 95.01	Std. Std.	(23-24) 13.1:1 Comp. 6443A 6443B		(23-24) 13.5:1 Comp. 4075DA 4075DB	(23-24) 13.1:1 Comp. VT24618B		Top End 35-0374	Cylinder Works 50009 Complete Kit 50009-K03 (95mm Std.)	Titanium Exhaust 28-64191 Titanium Intake 28-64192		CC-6443	Pro-X 03.6436 Wossner HR4068			
KTM 500 EXC, XC-W 2012-16 510cc Single Liquid Cooled 95mm 3.740" <i>CYL. WORKS COMPLETE KIT INCLUDES CYLINDER, PISTON, TOP END GASKETS</i>	AC	FL-5772		95.00 95.01	Std. Std.	11.8:1 Comp. 6512A 6512B	11.8:1 Comp. 40064M09500	11.8:1 Comp. 8821DA 8821DB	11.8:1 Comp. VT23762A VT23762B	11.8:1 Comp. 323900	Top End C3241-EST	Top End 35-0342 Complete w/ oil seals 37-1343		Steel Exhaust 28-64281 Titanium Intake (12-13) 28-64282 (14-16) 28-64332		CC-6508	Pro-X (12-13) 03.6512 Wossner (14-16) WR4066	SX07E39 49-822360 Pro-X Bearing / Seal Kit 49-64012 Hot Rods Bearing / Seal Kit 49K090	49-822360 49-822374	
	KTM 500 EXC-F 2017-24 KTM 500 XCF-W 2020-23 510cc Single Liquid Cooled 95mm 3.740" <i>CYL. WORKS COMPLETE KIT INCLUDES CYLINDER, PISTON, TOP END GASKETS</i>	AC	FL-5772		95.00 95.01 95.00 95.01	Std. Std. Std. Std.	(17-19) 11.8:1 Comp. 6512A 6512B (20-23) 12.75:1 Comp. 6513A 6513B	(17-19) 11.8:1 Comp. 40064M09500 (20-23) 12.75:1 Comp. 40272M09500	(17-19) 11.8:1 Comp. 8821DA 8821DB	(17-24) 11.8:1 Comp. VT23762A VT23762B		Top End C3604-EST	Top End 35-0991 Complete w/ oil seals (17-20) 37-1998	Cylinder Works 50010 (95mm Std.) Complete Kit (17-22) 50010-K01 (95mm Std.)	Steel Exhaust (17-19) 28-64281 (20-23) 28-64201 Titanium Intake (17-19) 28-64332 (20-23) 28-64192		(17-19) CC-1403 (20-23) CC-6328	Wossner (20-22) WR4079-R	NJ207ECP-1 49-822374 Pro-X Bearing / Seal Kit 49-64016 Hot Rods Bearing / Seal Kit 49K093	49-822374 49-822333
KTM 505 SX-F 2008-09 KTM 505 XC-F 2008-09 477cc Single Liquid Cooled 100mm 3.937" <i>RESLEEVEING REQUIRED FOR OVERSIZES</i>	AC	FL-5584	5584K	100.00 100.01 100.00	Std. Std. Std.	12.5:1 Comp. 6508A 6508B	12.5:1 Comp. 4947M10000	12.5:1 Comp. 8705DA 8705DB	12.5:1 Comp. VT23417A VT23417B		Top End 35-0336 Complete w/ oil seals 37-1336		Titanium Exhaust 28-64271 Titanium Intake 28-64272		CC-6427	Wossner WR4055	NJ206ECP-2 49-822333 Pro-X Bearing / Seal Kit 49-64007	49-822333 49-822274		
	KTM 520 SX, E/XC, M/XC 2000-07 KTM 525 SX, E/XC M/XC, XC-W 2003-07 510cc Liquid Cooled 95mm 3.740" <i>RESLEEVEING REQUIRED FOR OVERSIZES</i>	AC	FL-5437	11:1 5437K	95.00 95.01 97.00	Std. Std. .080	11:1 Comp. 6520A 6520B	11:1 Comp. 4731M09500	11:1 Comp. 8574DA 8574DB 8574D200	11:1 Comp. VT22942A VT22942B	Top End C7944-EST (95mm) C7691 (97mm)	Top End 35-0318 Complete w/ oil seals 37-1318		Steel Exhaust 28-65201 Steel Intake 28-65202 Valve Spring Kit 96-96000 Valve Seals Pkg. of 4 71029-4	Valve Guide Intake 96-96010 O/S+.001 96-96011 Exhaust 96-96020 O/S+.001 96-96021		Pro-X 04925 Wossner WR4048	NJ206ECP-1 49-822274 Pro-X Bearing / Seal Kit 49-64003		
KTM 525 2000-07 Big Bore to 565cc 100mm 3.937"	BB	FL-5437B		100.00	.200					Top End GS5437										





MODEL
Engine Description
Cylinder I.D. (mm/in.)



SLEEVE

REBUILD KIT
Sleeve • Piston
Gasket • T.E. Bearing

BORE SIZE (mm)

PISTON SIZE

TOP END

TOP END

VALVE TRAIN

BOTTOM END

PRO-X PISTON

WISECO PISTON

WOSSNER PISTON

VERTEX PISTON

JE PISTON

COMETIC GASKET

L.A. SLEEVE GASKET

CYLINDER AFTERMARKET KITS

VALVE / SPRING KIT

VALVE GUIDE

CAMSHAFT

CAM CHAIN

CRANKSHAFT

CON-ROD KIT

CRANK BEARING

ENGINE OIL SEAL KIT

BOTTOM END KIT
Crankshaft • Bearings • Seals • Gasket Set

KTM FOUR-STROKE (CONTINUED)

MODEL	AC	FL	BORE	STROKE	COMPRESSION	PRO-X PISTON	WISECO PISTON	WOSSNER PISTON	VERTEX PISTON	JE PISTON	COMETIC GASKET	L.A. SLEEVE GASKET	CYLINDER AFTERMARKET KITS	VALVE / SPRING KIT	VALVE GUIDE	CAMSHAFT	CAM CHAIN	CRANKSHAFT	CON-ROD KIT	CRANK BEARING	ENGINE OIL SEAL KIT	BOTTOM END KIT	
KTM 530 EXC-R, 2008-11 XC-W 510cc Single Liquid-Cooled 95mm 3.740"	AC	FL-5556	95.00 95.01	Std. Std.	11.9:1 Comp. 6528A 6528B			12.5:1 Comp. 8706DA 8706DB			Top End C3241-EST	Top End 35-0342 Complete w/ oil seals 37-1342		Steel Exhaust 28-64281 Titanium Intake 28-64282 Valve Spring Kit 96-96000	Valve Guide Intake 96-96010 O/S+.001 96-96011 Exhaust 96-96020 O/S+.001 96-96021			CC-6508		Pro-X 03.6528 Wossner WR4047	SX07E39 49-822359 Pro-X Bearing / Seal Kit 49-64012 (09-11)		
KTM 620 SC 1998-01 KTM 625 SXC LC4 2002-07 KTM 640 LC4 Duke 1998-07 620cc Single Liquid-Cooled 101mm 3.976"	AC	FL-5396	101.00 101.01	Std. Std.	11.7:1 Comp. 6604A 6604B			11.7:1 Comp. 8524DA 8524DB												Pro-X 03.6519 Wossner WR4014			
KTM 690 Enduro R 2008-18 KTM 690 Duke 2009-15 653cc Single Liquid-Cooled 102mm 4.016"	AC	FL-5716	102.00 102.01	Std. Std.	(08-11) 6608A 6608B																		
KTM 690 Enduro R 2019-23 KTM 690 Duke 2016-17 690cc Single Liquid-Cooled 105mm 4.134"	AC	FL-5808																					



GASGAS
HONDA
HUSQVARNA
KAWASAKI
KTM
SUZUKI
YAMAHA
DIRT BIKE SLEEVES
STREET BIKE SLEEVES
ACCESSORIES
TECHNICAL



SLEEVE
REBUILD KIT
Sleeve, Piston
 Gasket, T.E. Bearing
BORE SIZE (mm)
PISTON SIZE

TOP END

PRO-X PISTON
WISECO PISTON
WOSSNER PISTON
VERTEX PISTON

TOP END

T.E. BEARING
COMETIC GASKET
L.A. SLEEVE GASKET

BOTTOM END

CRANKSHAFT
CON-ROD KIT
CON-ROD ASSEMBLY
Rod • Bearings • Seals
CRANK BEARING
CRANK SEAL KIT
BOTTOM END KIT
Crankshaft • Bearings •
 Seals • Gasket Set

MODEL
 Engine Description
 Cylinder I.D. (mm/in.)

SUZUKI TWO-STROKE

JR-50 49cc 41mm	1996-06 1.614"	CC	FL-5492	5492K	41.00 41.50 42.00 43.00	Std. .020 .040 .080	01.3001 01.3001.50 01.3001.100	826M04100 826M04150 826M04200 826M04300				Top End C7014	Top End 35-0416						
RM-60 60cc 43mm	2003 Liquid Cooled 1.693"	AC	KA-935	935K	43.00 43.25 43.50 44.00 45.00	Std. .010 .020 .040 .080	4290A 4291 4293 4304	648M04300 648M04350 648M04400 648M04500				T.E. Bearing 01215	Top End C7501	Top End 35-4100 Complete with Oil Seals 37-4100	HR4015	Pro-X 04982	39-4982	6304C3	094481 Bearing / Seal Kit 494481
RM-65 64.7cc 44.5mm	2003-06 Liquid Cooled 1.752"	AC	KA-5472	5472K	44.50 45.00 46.50	Std. .020 .080	4309A	752M04450 752M04500 752M04650	8196DA			T.E. Bearing 01215	Top End C7736 (45mm) C7682 (47mm)	Top End 35-4021 Complete with Oil Seals 37-4021	HR4014	Pro-X 04982	39-4982	6304C3	094481 Bearing / Seal Kit 494481
RM-80 G,H 82cc 47.5mm	1986-87 Liquid Cooled 1.870"	CI	FL-973	973K	47.50 49.00 49.50	Std. .060 .080		542M04750 542M04900 542M04950				T.E. Bearing 01403	Top End C7052			Pro-X 04976		Left 6204C3 Right 6304C3	
RM-80 J 82cc 47.5mm	1988 Liquid Cooled 1.870"	CS	FL-5048		47.50	Std.						T.E. Bearing 01403	Top End C7052			Pro-X 04976		Left 6204C3 Right 6304C3	
RM-80 K,L 82cc 47.5mm	1989-90 Liquid Cooled 1.870"	CS	FL-5091	5091K	47.50 48.00 48.50	Std. .020 .040		579M04750 579M04800 579M04850				T.E. Bearing 01403	Top End C7053			Pro-X 04976 (89) 04977 (90)	39-4977 (90)	6304C3	094384 Bearing / Seal Kit 494384
RM-80 82cc 47.5mm	1991-01 Liquid Cooled 1.870"	CS	FL-5140	5140K	47.50 48.00 48.25 48.50 48.75 49.00 49.50	Std. .020 .030 .040 .050 .060 .080	5082 5083 5084 5085 5086 5088	645M04750 645M04800 645M04850 645M04900 645M04950	8270DA 8270D050 8270D100 8270D150 8270D200			T.E. Bearing 01403	Top End C7054	Top End 35-3111 Complete with Oil Seals 37-3111		Pro-X 04977 Hot Rods HR8127	39-4977 (91-98) 39-4977 (99-01)	6304C3	094384 (91-98) 094398 (99-01) Bearing / Seal Kit 494384 (91-98) 494398 (99-01)
RM-85 (03B2, 03B3) 85cc 48mm	2002-23 Liquid Cooled 1.870"	AC	FL-5479	5479K	48.00 48.50 49.00 50.00	Std. .020 .040 .080	5090A	806M04800 806M04850 806M04900 806M05000	8103DA	VT22877B		T.E. Bearing 01403	Top End C7857	Top End 35-3122 Complete with Oil Seals 37-3122	HR4067	Pro-X 04934 Hot Rods HR8610	39-4934	6304C3	094398 Bearing / Seal Kit 494398
RM-85 Big Bore to 100cc 52mm	2002-23 2.047"	AC	FL-5479B		52.00	.157		806M05200		VT23205400		T.E. Bearing 01403	Top End C7857	Top End 35-3122	HR4067	Pro-X 04934 Hot Rods HR8610	39-4934	6304C3	094398 Bearing / Seal Kit 494398

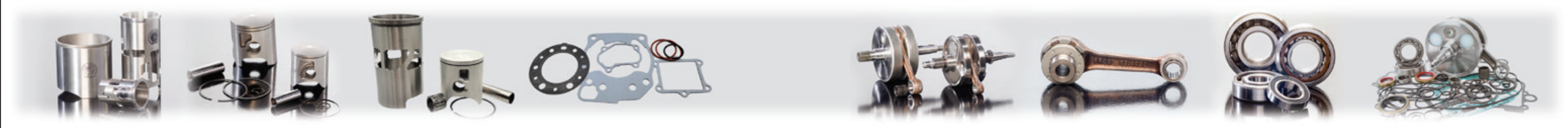

GASGAS
HONDA
HUSQVARNA
KAWASAKI
KTM
SUZUKI
YAMAHA
DIRT BIKE SLEEVES
STREET BIKE SLEEVES
ACCESSORIES
TECHNICAL



MODEL
Engine Description
Cylinder I.D. (mm/in.)



SLEEVE

REBUILD KIT
Sleeve - Piston
Gasket - T.E. Bearing

BORE SIZE (mm)

PISTON SIZE

TOP END

TOP END

BOTTOM END

PRO-X PISTON

WISECO PISTON

WOSSNER PISTON

VERTEX PISTON

T.E. BEARING

COMETIC GASKET

L.A. SLEEVE GASKET

CRANKSHAFT

CON-ROD KIT

CON-ROD ASSEMBLY
Rod - Bearings - Seals

CRANK BEARING

CRANK SEAL KIT

BOTTOM END KIT
Crankshaft - Bearings - Seals - Gasket Set

SUZUKI TWO-STROKE (CONTINUED)

MODEL	Year	AC	KA-5358	5358K	52.50	Std.	4383A	651M05250	8254DA			T.E. Bearing	Top End		HR4016	Pro-X	39-4941	6304C3	094481		
RM-100 99cc Liquid Cooled 52.5mm	2003				53.00 54.50	.020 .080		651M05300 651M05450	8254D050			01303	C7392 (53mm) C7413 (54.5mm)			04941		Bearing / Seal Kit 494481			
<i>CYLINDER SLEEVING REQUIRED FOR OVERSIZES</i>																					
RM-125 X 123cc Liquid Cooled 54mm	1981	CI/L	FL-722		54.00 54.25	.Std. .010	2691	511M05400	8124DA			01151						Left 6205C3 Right 6322X	094386		
<i>SPECIAL HEAVY O.D. TO REPAIR BROKEN CYLINDER SKIRTS</i>																					
		CS/MO	FL-722H		55.00 55.25	.040 .050	2695	511M05500													
		CS/MO	FL-722H		55.75 56.00 56.25	.070 .080 .090	2697 2698 2699	511M05600													
RM-125 Z,D 123cc Liquid Cooled 54mm	1982-83	CI/L	FL-748		54.00 54.25	.Std. .010	2691	511M05400	8124DA			01151	C7103 (83)					Left 6205C3 Right 6322X	094387		
<i>SPECIAL HEAVY O.D. TO REPAIR BROKEN CYLINDER SKIRTS</i>																					
		CS/MO	FL-748H		55.00 55.25	.040 .050	2695	511M05500													
		CS/MO	FL-748H		55.75 56.00 56.25	.070 .080 .090	2697 2698 2699	511M05600													
RM-125 E 123cc Liquid Cooled 54mm	1984	CI/L	FL-900		54.00 54.25	.Std. .010	2691	511M05400	8124DA			01151	C7055			Hot Rods HR8162		Left 6205C3 Right 6322X	094387		
<i>SPECIAL HEAVY O.D. TO REPAIR BROKEN CYLINDER SKIRTS</i>																					
		CS/MO	FL-900H		55.00 55.25	.040 .050	2695	511M05500													
		CS/MO	FL-900H		55.75 56.00 56.25	.070 .080 .090	2697 2698 2699	511M05600													
RM-125 F 123cc Liquid Cooled 54mm	1985	CI/L	FL-900		54.00	.Std.		519M05400				01151	C7055			Hot Rods HR8162		Left 6205C3 Right 6322X	094387		
<i>SPECIAL HEAVY O.D. TO REPAIR BROKEN CYLINDER SKIRTS</i>																					
		CS/MO	FL-900H		54.50 54.75 55.00 55.25 55.50	.020 .030 .040 .050 .060	2684 2685 2686 2687	519M05450 519M05500													
		CS/MO	FL-900H		55.75 56.00 56.25	.070 .080 .090	2597 2598 2599	519M05600													
RM-125 G 123cc Liquid Cooled 54mm	1986	CI/L	FL-974		54.00 54.50 54.75	.Std. .020 .030	2684	519M05400 519M05450				01151	C7056			Hot Rods HR8162		Left 6205C3 Right 6322X	094388		
<i>SPECIAL HEAVY O.D. TO REPAIR BROKEN CYLINDER SKIRTS</i>																					
		CS/MO	FL-974H		55.00 55.25 55.50	.040 .050 .060	2686 2687	519M05500													
		CS/MO	FL-974H		55.75 56.00 56.25	.070 .080 .090	2597 2598 2599	519M05600													
RM-125 H 123cc Liquid Cooled 54mm	1987	CI/L	FL-5011		54.00 54.25	.Std. .010	4101	557M05400				01151	C7057					Left 6205C3 Right 6322X	094388		
<i>SPECIAL HEAVY O.D. TO REPAIR BROKEN CYLINDER SKIRTS</i>																					
		CS/MO	FL-5011H		54.75 55.00 55.25 55.50 55.75	.030 .040 .050 .060 .070	4103 4104 4105 4106 4107	557M05500													

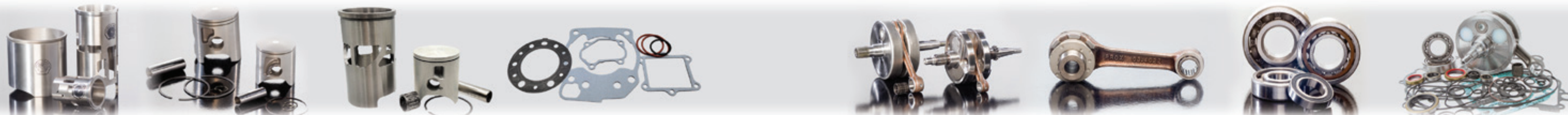

GASGAS
HONDA
HUSQVARNA
KAWASAKI
KTM
SUZUKI
YAMAHA
DIRT BIKE SLEEVES
STREET BIKE SLEEVES
ACCESSORIES
TECHNICAL



MODEL
Engine Description
Cylinder I.D. (mm/in.)

SLEEVE

REBUILD KIT
Sleeve, Piston
Gasket, T.E. Bearing

BORE SIZE (mm)

PISTON SIZE

TOP END

TOP END

BOTTOM END

PRO-X PISTON

WISECO PISTON

WOSSNER PISTON

VERTEX PISTON

T.E. BEARING

COMETIC GASKET

L.A. SLEEVE GASKET

CRANKSHAFT

CON-ROD KIT

CON-ROD ASSEMBLY
Rod • Bearings • Seals

CRANK BEARING

CRANK SEAL KIT

BOTTOM END KIT
Crankshaft • Bearings • Seals • Gasket Set

SUZUKI TWO-STROKE (CONTINUED)

RM-125 J 123cc Liquid Cooled 54mm 2.126"	1988	CI/L	FL-5049		54.00 54.25 54.50 54.75 55.00 55.25 55.50 55.75	Std. .010 .020 .030 .040 .050 .060 .070	5011 5012 5013 5014 5015 5016 5017					T.E. Bearing 01153	Top End C7057			Pro-X 04966 Hot Rods HR8110		Left 6205C3 Right 6322X Bearing / Seal Kit 494388	094388		
<i>SPECIAL HEAVY O.D. TO REPAIR BROKEN CYLINDER SKIRTS</i>				CS/MO	FL-5049H																
RM-125 K 124cc Liquid Cooled 54mm 2.126"	1989	CI/L	FL-5092		54.00 54.25 54.50 54.75 55.00 55.25 55.50 56.00	Std. .010 .020 .030 .040 .050 .060 .080	5020 5021 5022 5023 5024 5026	641M05400 641M05450 641M05500 641M05550 641M05600	8055DA 8055D050 8055D100			T.E. Bearing 01153	Top End C7058			Pro-X 04966 Hot Rods HR8110	39-4966	6322X Bearing / Seal Kit 496322	094384		
<i>POWER VALVE MUST BE MODIFIED FOR .040 OVERSIZE PISTON & LARGER</i>																					
RM-125 L 124cc Liquid Cooled 54mm 2.126"	1990	AC	FL-5106	5106K	54.00 54.01 54.25 54.50 55.00 55.50 56.00	Std. Std. .010 .020 .040 .060 .080	5050A 5050B 5051 5052	641M05400 641M05450 641M05500 641M05550 641M05600	8055DA 8055DB 8055D050 8055D100	VT22216A VT22216B		T.E. Bearing 01153	Top End C7120			Pro-X 04966 Hot Rods HR8110	39-4966	6322X Bearing / Seal Kit 496322	094384		
<i>CYLINDER SLEEVING REQUIRED FOR OVERSIZES</i>																					
RM-125 M,N 124cc Liquid Cooled 54mm 2.126"	1991-92	AC	FL-5108	5108K (91) 5108K-1 (92)	54.00 54.01 54.25 54.50 55.00 55.50 56.00	Std. Std. .010 .020 .040 .060 .080	5050A 5050B 5051 5052	641M05400 641M05450 641M05500 641M05550 641M05600	8055DA 8055DB 8055D050 8055D100	VT22216A VT22216B		T.E. Bearing 01153	Top End C7059 (91) C7112 (92)	Top End 35-3212 (92) Complete with Oil Seals 37-3212 (92)		Pro-X 04966 Hot Rods HR8110	39-4966	6322X Bearing / Seal Kit 496322	094384		
<i>CYLINDER SLEEVING REQUIRED FOR OVERSIZES</i>																					
RM-125 P (No. 40) 124cc Liquid Cooled 54mm 2.126"	1993	AC	FL-5181	5181K	54.00 54.01 54.25 54.50 55.00 55.50 56.00	Std. Std. .010 .020 .040 .060 .080	5050A 5050B 5051 5052	641M05400 641M05450 641M05500 641M05550 641M05600	8055DA 8055DB 8055D050 8055D100	VT22216A VT22216B		T.E. Bearing 01153	Top End C7136	Top End 35-3212 Complete with Oil Seals 37-3212		Pro-X 04966 Hot Rods HR8110	39-4966	6322X Bearing / Seal Kit 496322	094384		
<i>CYLINDER SLEEVING REQUIRED FOR OVERSIZES</i>																					
RM-125 (No. 50, 60, 70) 124cc Liquid Cooled 54mm 2.126"	1994-96	AC	FL-5255	5255K	54.00 54.01 54.25 54.50 55.00 55.50 56.00	Std. Std. .010 .020 .040 .060 .080	5050A 5050B 5051 5052	641M05400 641M05450 641M05500 641M05550 641M05600	8055DA 8055DB 8055D050 8055D100	VT22216A VT22216B		T.E. Bearing 01153	Top End C7136	Top End 35-3212 Complete with Oil Seals 37-3212		Pro-X 04966 Hot Rods HR8110	39-4966	6322X Bearing / Seal Kit 496322	094384		
<i>CYLINDER SLEEVING REQUIRED FOR OVERSIZES</i>																					
RM-125 124cc Liquid Cooled 54mm 2.126"	1997	AC	FL-5323	5323K	54.00 54.01 54.25 54.50 55.00 55.50 56.00	Std. Std. .010 .020 .040 .060 .080	5050A 5050B 5051 5052	641M05400 641M05450 641M05500 641M05550 641M05600	8055DA 8055DB 8055D050 8055D100	VT22216A VT22216B		T.E. Bearing 01153	Top End C7136	Top End 35-3212 Complete with Oil Seals 37-3212		Pro-X 04988 Hot Rods HR8142	39-4988	6322X Bearing / Seal Kit 496322	094384		
<i>CYLINDER SLEEVING REQUIRED FOR OVERSIZES</i>																					
RM-125 124cc Liquid Cooled 54mm 2.126"	1998-99	AC	FL-5346	5346K	54.00 54.01 54.25 54.50 55.00 55.50	Std. Std. .010 .020 .040 .060	5050A 5050B 5051 5052	641M05400 641M05450 641M05500 641M05550	8055DA 8055DB 8055D050 8055D100	VT22216A VT22216B		T.E. Bearing 01153	Top End C7136	Top End 35-3219 Complete with Oil Seals 37-3219		Pro-X 04988 (98) 04943 (99)	39-4988 (98) 39-4943 (99)	6322X Bearing / Seal Kit 496322 (98) 496322X (99)	094384 (98) 094398 (98)		
<i>CYLINDER SLEEVING REQUIRED FOR OVERSIZES</i>																					

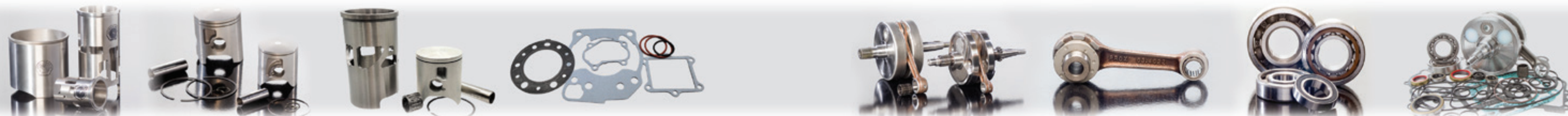



MODEL
Engine Description
Cylinder I.D. (mm/in.)

SLEEVE

REBUILD KIT
Sleeve - Piston
Gasket - T.E. Bearing

BORE SIZE (mm)

PISTON SIZE

TOP END

TOP END

BOTTOM END

PRO-X PISTON

WISECO PISTON

WOSSNER PISTON

VERTEX PISTON

T.E. BEARING

COMETIC GASKET

L.A. SLEEVE GASKET

CRANKSHAFT

CON-ROD KIT

CON-ROD ASSEMBLY
Rod - Bearings - Seals

CRANK BEARING

CRANK SEAL KIT

BOTTOM END KIT
Crankshaft - Bearings - Seals - Gasket Set

SUZUKI TWO-STROKE (CONTINUED)

RM-125 124cc 54mm Liquid Cooled 2.126" CYLINDER SLEEVING REQUIRED FOR OVERSIZES	2000-03 AC FL-5420	5420K (00) 5420K-1 (01-03)	54.00	Std.	5060A 5060B	754M05400 754M05450 754M05500 754M05550 754M05600	8061DA 8061DB 8061D050 8061D100	VT22652B		T.E. Bearing 01153	Top End C7136 (00) C7778 (01-03)	Top End 35-3219 Complete with Oil Seals 37-3219 (00) 37-3220 (01-03)	HR4032 (01-03)	Pro-X 04943 Wossner WR2013	39-4943	6322X	094398	Hot Rods CBK0074 (01-03)	
			54.01	.020															
RM-125 (36F, 36F1) 124cc 54mm Liquid Cooled 2.126" CYLINDER SLEEVING REQUIRED FOR OVERSIZES	2004-10 AC FL-5532	5532K	54.00	Std.	5110B 5110C	835M05400 835M05600	8098DA 8098DB 8098D200	VT22998B		T.E. Bearing 01153	Top End C7508	Top End 35-3221 Complete with Oil Seals 37-3221	HR4041	Pro-X 04918	39-4918	6322X	094398	Hot Rods CBK0081	
			54.01	.080															
RM-125 Big Bore to 144c 58mm 2.283" HEAD & POWER VALVE MODIFICATION REQUIRED CYLINDER SLEEVING REQUIRED	2004-09 AC FL-5532B		58.00	.160		836M05800	8098D400				Top End C7508	Top End 35-3221							
RM-250 E, F 246cc 70mm Liquid Cooled 2.756" SPECIAL HEAVY O.D. TO REPAIR BROKEN CYLINDER SKIRTS	1984-85 CI/MO FL-869		70.00	Std.	2787 2789	485M07000 485M07050 485M07100				T.E. Bearing 01251	Top End C7060						Left 6206C3	094391	
			70.25	.010															
RM-250 G 246cc 67mm Liquid Cooled 2.638"	1986 CS/MO FL-976		67.00	Std.			8158DA			T.E. Bearing 01251	Top End C7061						Left 6206C3	094392	
																			Right 6305C3
RM-250 G 246cc 67mm Liquid Cooled 2.638" CYLINDER SLEEVING REQUIRED FOR OVERSIZES	1987 AC FL-5012		67.00	Std.	558M06700 558M06800 558M06900					T.E. Bearing 01251	Top End C7062			Hot Rods HR8105		Left 6206C3	094392		
			68.00	.040															
RM-250 G 246cc 67mm Liquid Cooled 2.638" CYLINDER SLEEVING REQUIRED FOR OVERSIZES	1988 AC FL-5053		67.00	Std.	558M06700 558M06800 558M06900					T.E. Bearing 01251	Top End C7062			Hot Rods HR8105		Left 6206C3	094392		
			68.00	.040															
			69.00	.080													Right 6305C3		

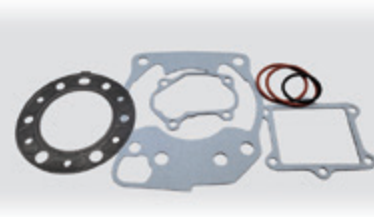

GASGAS
HONDA
HUSQVARNA
KAWASAKI
KTM
SUZUKI
YAMAHA
DIRT BIKE SLEEVES
STREET BIKE SLEEVES
ACCESSORIES
TECHNICAL



MODEL
Engine Description
Cylinder I.D. (mm/in.)

SLEEVE

REBUILD KIT
Sleeve - Piston
Gasket - T.E. Bearing

BORE SIZE (mm)

PISTON SIZE

TOP END

TOP END

BOTTOM END

PRO-X PISTON

WISECO PISTON

WOSSNER PISTON

VERTEX PISTON

T.E. BEARING

COMETIC GASKET

L.A. SLEEVE GASKET

CRANKSHAFT

CON-ROD KIT

CON-ROD ASSEMBLY
Rod - Bearings - Seals

CRANK BEARING

CRANK SEAL KIT

BOTTOM END KIT
Crankshaft - Bearings - Seals - Gasket Set

SUZUKI TWO-STROKE (CONTINUED)

MODEL	Year	AC	FL	BORE	STROKE	PRO-X PISTON	WISECO PISTON	WOSSNER PISTON	VERTEX PISTON	T.E. BEARING	COMETIC GASKET	L.A. SLEEVE GASKET	CRANKSHAFT	CON-ROD KIT	CON-ROD ASSEMBLY	CRANK BEARING	CRANK SEAL KIT	BOTTOM END KIT	
RM-250 K, L RMX-250 246cc Liquid Cooled 67mm 2.638"	1989-90	AC	FL-5093	67.00 67.50 68.00 69.00	Std. .020 .040 .080	5070B	642M06700 642M06750 642M06800 642M06900	8022DA 8022D050 8022D100 8022D200	VT22215A	T.E. Bearing 01251	Top End C7063 (89) C7064 (90) C7257 (RMX)	Top End 35-3310 Complete with Oil Seals 37-1575 (89) 37-1576 (90)		Pro-X 04983 Hot Rods HR8105	39-4983 (RM) 39-4396 (RMX)	6305C3 (RM) Left 6328C3 (RMX) Right 6305C3 (RMX)	094392 (RM) 094396 (RMX)		
<i>CYLINDER SLEEVING REQUIRED FOR OVERSIZES</i>																			
RM-250, M, N RMX-250 249cc Liquid Cooled 67mm 2.638"	1991-92	AC	FL-5182	67.00 67.50 68.00 69.00	Std. .020 .040 .080	5070B	642M06700 642M06750 642M06800 642M06900	8022DA 8022D050 8022D100 8022D200	VT22215A	T.E. Bearing 01251	Top End C7065 (91) C7123 (92) C7257 (RMX)	Top End 35-3311 Complete with Oil Seals 37-1569 (91) 37-1577 (92)		Pro-X 04983 Hot Rods HR8105	39-4983 (RM) 39-4396 (RMX)	6305C3 (RM) Left 6328C3 (RMX) Right 6305C3 (RMX)	094393 (RM) 094396 (RMX)		
<i>CYLINDER SLEEVING REQUIRED FOR OVERSIZES</i>																			
RM-250 P (No. 40) 249cc Liquid Cooled 67mm 2.638"	1993	AC	FL-5182	5182K	67.00 67.50 68.00 69.00	Std. .020 .040 .080	5070B	642M06700 642M06750 642M06800 642M06900	8022DA 8022D050 8022D100 8022D200	VT22215A	T.E. Bearing 01251	Top End C7123	Top End 35-3311 Complete with Oil Seals 37-1577		Pro-X 04983 Hot Rods HR8105	39-4983	6305C3	094393	
<i>CYLINDER SLEEVING REQUIRED FOR OVERSIZES</i>																			
RM-250 (No. 50) 249cc Liquid Cooled 67mm 2.638"	1994	AC	FL-5217	5217K	67.00 67.50 68.00 69.00	Std. .020 .040 .080	5070B	642M06700 642M06750 642M06800 642M06900	8022DA 8022D050 8022D100 8022D200	VT22215A	T.E. Bearing 01251	Top End C7156	Top End 35-3311 Complete with Oil Seals 37-1581		Pro-X 04983 Hot Rods HR8105	39-4394	6328C3	094394	
<i>CYLINDER SLEEVING REQUIRED FOR OVERSIZES</i>																			
RM-250 (No. 60) 249cc Liquid Cooled 67mm 2.638"	1995	AC	FL-5256	5256K	67.00 67.50 68.00 69.00	Std. .020 .040 .080	5070B	642M06700 642M06750 642M06800 642M06900	8022DA 8022D050 8022D100 8022D200	VT22215A	T.E. Bearing 01251	Top End C7156	Top End 35-3311 Complete with Oil Seals 37-1581		Pro-X 04983 Hot Rods HR8105	39-4394	6328C3	094394	
<i>CYLINDER SLEEVING REQUIRED FOR OVERSIZES</i>																			
RM-250 249cc Liquid Cooled 66.4mm 2.614"	1996	AC	FL-5295	5295K	66.40 66.41	Std. Std.	4420A 4420B	681M06640	8058DA 8058DB	VT22386B	T.E. Bearing 01251	Top End C7280	Top End 35-3316 Complete with Oil Seals 37-3316		Pro-X 04984 Hot Rods HR8141	39-4984	6328C3	094395	
<i>CYLINDER SLEEVING REQUIRED FOR OVERSIZES</i>																			
RM-250 (No. 10) 249cc Liquid Cooled 66.4mm 2.614"	1997	AC	FL-5324	5324K	66.40 66.41	Std. Std.	4420A 4420B	681M06640	8058DA 8058DB	VT22386B	T.E. Bearing 01251	Top End C7280	Top End 35-3316 Complete with Oil Seals 37-3316		Pro-X 04984 Hot Rods HR8141	39-4984	6328C3	094395	
<i>CYLINDER SLEEVING REQUIRED FOR OVERSIZES</i>																			

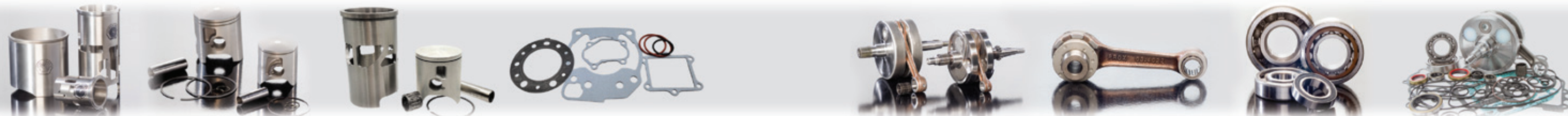

GASGAS
HONDA
HUSQVARNA
KAWASAKI
KTM
SUZUKI
YAMAHA
DIRT BIKE SLEEVES
STREET BIKE SLEEVES
ACCESSORIES
TECHNICAL



MODEL
Engine Description
Cylinder I.D. (mm/in.)

SLEEVE

REBUILD KIT
Sleeve - Piston
Gasket - T.E. Bearing

BORE SIZE (mm)

PISTON SIZE

TOP END

TOP END

BOTTOM END

PRO-X PISTON

WISECO PISTON

WOSSNER PISTON

VERTEX PISTON

T.E. BEARING

COMETIC GASKET

L.A. SLEEVE GASKET

CRANKSHAFT

CON-ROD KIT

CON-ROD ASSEMBLY
Rod • Bearings • Seals

CRANK BEARING

CRANK SEAL KIT

BOTTOM END KIT
Crankshaft • Bearings • Seals • Gasket Set

SUZUKI TWO-STROKE (CONTINUED)

Table with columns for Model, Year, AC, FL, Part Number, Bore Size, Piston Size, Piston Type, T.E. Bearing, Top End, L.A. Sleeve Gasket, Crankshaft, Con-Rod Kit, Con-Rod Assembly, Crank Bearing, Crank Seal Kit, Bottom End Kit. Includes rows for Suzuki RM-250 and RMX-250 models from 1998 to 2008.

GASGAS
HONDA
HUSQVARNA
KAWASAKI
KTM
SUZUKI
YAMAHA
DIRT BIKE SLEEVES
STREET BIKE SLEEVES
ACCESSORIES
TECHNICAL

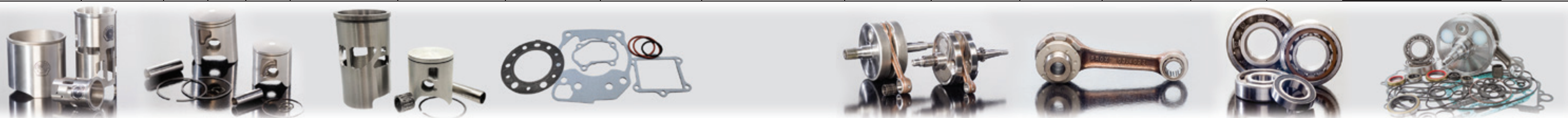



MODEL
Engine Description
Cylinder I.D. (mm/in.)



SLEEVE

REBUILD KIT
Sleeve • Piston
Gasket • T.E. Bearing

BORE SIZE
(mm)

PISTON SIZE

TOP END

TOP END

VALVE TRAIN

BOTTOM END

PRO-X PISTON

WISECO PISTON

WOSSNER PISTON

VERTEX PISTON

JE PISTON

COMETIC GASKET

L.A. SLEEVE GASKET

CYLINDER AFTERMARKET KITS

VALVE / SPRING KIT

VALVE GUIDE

CAMSHAFT

CAM CHAIN

CRANKSHAFT

CON-ROD KIT

CRANK BEARING

ENGINE OIL SEAL KIT

BOTTOM END KIT
Crankshaft • Bearings • Seals • Gasket Set

SUZUKI FOUR-STROKE

DR-Z110 124cc 53mm	2003-06 Single 2.086"	RS	KA-5493		53.00 53.50 53.50	Std. .020 .020		11:1 Comp. 4875M05350 4875M05400				Top End C7939-EST		Top End 35-0415			Camshaft 2027-1								
DR-Z125 DR, SP-125 124cc 57mm	2003-24 1982-97 Single 2.244"	CI	FL-753		57.00 58.00 61.00	Std. .040 .160		11:1 Comp. 4815M05700 4815M05800 4815M06100				Top End (03-19 DRZ) C7835 (59mm) C3109 (61mm)		Top End (03-17 DRZ) 35-0531 (18-21 DRZ) 35-0037			Camshaft 2027-1								
DR-200 SL DR-200 SE DR, SP-200 199cc 66mm	2015-19 2005-13 1986-04 Single 2.598"	AC AC CI	FL-975											Top End 35-0532											
RM-Z250 249cc 77mm <i>RESLEEVEING REQUIRED FOR OVERSIZES</i> <i>CYL. WORKS COMPLETE KIT INCLUDES CYLINDER, PISTON, TOP END GASKETS</i>	2004-06 Liquid Cooled 3.031"	AC	KA-5530	5530K	77.00 79.00 77.00 79.00	Std. .080 Std. .080	12.6:1 01.4335A 4358	12.6:1 Comp. 8582DA	12.6:1 Comp. VT22982A			Top End C3174-EST C3056-EST (80mm)		Top End 35-4334 Complete w/ oil seals 37-1463	Cylinder Works 30001 (Std. 77mm) Cylinder Works Complete Kit 30001-K01 (Std. 77mm)	Titanium Exhaust 28-43341 Titanium Intake 28-43342 Steel Exhaust 60-60213H Steel Intake 60-60210H Valve Spring Kit 60-60170	Valve Guide IN / EX 60-60190 Valve Seals Pkg. of 4 71013-4 Complete Head Service Kit 60-61800 Includes Std. Valves, Guides, Spring Kit, Seals, Gaskets	Hot Cams Camshaft 2041-1IN (Intake) 2040-1E (Exhaust)	CC-2402	HR4064	Pro-X 04919	6206RI Bearing / Seal Kit 49K043	49-822223	Hot Rods CBK0099	
RM-Z250 249cc 77mm <i>RESLEEVEING REQUIRED FOR OVERSIZES</i> <i>CYL. WORKS COMPLETE KIT INCLUDES CYLINDER, PISTON, TOP END GASKETS</i>	2007-09 Liquid Cooled 3.031"	AC	KA-5530	5530K-3	77.00 77.01 79.00 77.00	Std. Std. .080 Std.	13.4:1 Comp. 01.3338A 01.3338B	13.4:1 Comp. 4921M07700	13.4:1 Comp. 8666DA 8666DB	13.4:1 Comp. VT23311A VT23311B		Top End C3175-EST C3177-EST (79mm)		Top End 35-0568 Complete w/ oil seals 37-1568	Cylinder Works 40003 (Std. 77mm) Cylinder Works Complete Kit 40003-K01 (Std. 77mm)	Pro-X Titanium Exhaust 28-33371 Titanium Intake 28-33372 Kibblewhite Steel Exhaust 60-60516H Steel Intake 60-60512H Valve Spring Kit 60-60500	Valve Guide IN / EX 60-60520 O/S+.001 60-60521 Valve Seals Pkg. of 4 71013-4 Complete Head Service Kit 60-61810 Includes Std. Valves, Guides, Spring Kit, Seals, Gaskets	Hot Cams Camshaft 2087-2IN (Intake) 2088-2E (Exhaust)	CC-2402	HR4081	Pro-X 04919	830046-14 Bearing / Seal Kit 49K055	49-822329	Hot Rods CBK0117	



GASGAS
HONDA
HUSQVARNA
KAWASAKI
KTM
SUZUKI
YAMAHA
DIRT BIKE SLEEVES
STREET BIKE SLEEVES
ACCESSORIES
TECHNICAL



MODEL
Engine Description
Cylinder I.D. (mm/in.)



SLEEVE

REBUILD KIT
Sleeve • Piston
Gasket • T.E. Bearing

BORE SIZE
(mm)

PISTON SIZE

TOP END

TOP END

VALVE TRAIN

BOTTOM END

PRO-X PISTON

WISECO PISTON

WOSSNER PISTON

VERTEX PISTON

JE PISTON

COMETIC GASKET

L.A. SLEEVE GASKET

CYLINDER AFTERMARKET KITS

VALVE / SPRING KIT

VALVE GUIDE

CAMSHAFT

CAM CHAIN

CRANKSHAFT

CON-ROD KIT

CRANK BEARING

ENGINE OIL SEAL KIT

BOTTOM END KIT
Crankshaft • Bearings • Seals • Gasket Set

SUZUKI FOUR-STROKE (CONTINUED)

MODEL	Year	AC	Code	5530K-2	77.00	Std.	13.4:1 Comp.	13.4:1 Comp.	13.6:1 Comp.	13.5:1 Comp.	13.5:1 Comp.	Top End	Top End	Cylinder Works	Pro-X	Valve Guide	Hot Cams	CC-2402	Pro-X	830046-20	49-822329	
RM-Z250	2010-18	AC	KA-5530	5530K-2	77.00	Std.	01.3341A	40007M07700	8781DA	VT23861A	299244	C3406-EST	35-0567	40004	28-33371	60-60520	2200-11N	CC-2402	04919	Bearing / Seal Kit	49K074	
					77.01	Std.	01.3341B		8781DB	VT23861B												
					77.00	Std.		40012M07700	8795DA	VT23862A	299245											
CYL. WORKS COMPLETE KIT INCLUDES CYLINDER, PISTON, TOP END GASKETS																						
RM-Z250	2019-24	AC	FL-5750		77.00	Std.	01.3341A	40007M07700	8781DA	VT24122A	366827	C3406-EST	35-0567	40005	28-33371	60-60520	2200-11N	CC-2402	04919	Bearing / Seal Kit	49K074	
					77.01	Std.	01.3341B		8781DB	VT24122B												
CYL. WORKS COMPLETE KIT INCLUDES CYLINDER, PISTON, TOP END GASKETS																						
DR-250	1990-95	CI	FL-5130																			
DR-Z250	2001-07	CI AC	FL-5130	5130K	73.00	Std.	4776M07300		8678DA			C7968	35-0588									
DR-Z250	2001-07	BB	FL-5130B		80.00	.275			8678D700			C7969										
Big Bore to 300cc																						
DR-350	1990-99	CI	FL-5112	5112K	79.00	Std.	4576M07900		8600DA			C7068	35-0584		28-30281	60-6030				Left	49-822194	
					80.00	.040	4576M08000		8600D100			(79-80mm)									Right	
					81.00	.080	4576M08100		8600D200													
					82.00	.120			8600D300			C7157	37-1584		28-30282	71015-4						
(81-82mm)																						
Complete w/ oil seals																						
Valve Spring Kit																						



GASGAS
HONDA
HUSQVARNA
KAWASAKI
KTM
SUZUKI
YAMAHA
DIRT BIKE SLEEVES
STREET BIKE SLEEVES
ACCESSORIES
TECHNICAL



MODEL
Engine Description
Cylinder I.D. (mm/in.)

SUZUKI FOUR-STROKE (CONTINUED)

		SLEEVE				TOP END						TOP END				VALVE TRAIN				BOTTOM END						
		SLEEVE	REBUILD KIT <small>Sleeve • Piston Gasket • T.E. Bearing</small>	BORE SIZE <small>(mm)</small>	PISTON SIZE	PRO-X PISTON	WISECO PISTON	WOSSNER PISTON	VERTEX PISTON	JE PISTON	COMETIC GASKET	L.A. SLEEVE GASKET	CYLINDER AFTERMARKET KITS	VALVE / SPRING KIT	VALVE GUIDE	CAMSHAFT	CAM CHAIN	CRANKSHAFT	CON-ROD KIT	CRANK BEARING	ENGINE OIL SEAL KIT	BOTTOM END KIT <small>Crankshaft • Bearings • Seals • Gasket Set</small>				
DR-350	1990-99	CS	FL-5112H																							
Heavy O.D. Allows Big Bore to 385cc 79mm 3.110" 83mm 3.268"				83.00	.160		10.5:1 Comp. 4576M08300	9:1 Comp. 8600D400				C7263 (83mm)														
DR-350	1990-99	CS	FL-5112B																							
Big Bore to 450cc 89mm 3.503"				89.00								10.5:1 Comp. 130928	Top End C7264 (91mm)													
DR-Z 400 E, S	2000-24	AC	FL-5430	5430K																						
398cc Liquid Cooled 90mm 3.543" <i>RESLEEVING REQUIRED FOR OVERSIZES</i> <i>CYL. WORKS COMPLETE KIT INCLUDES CYLINDER, PISTON, TOP END GASKETS</i>				90.00 90.01 91.00 92.00	Std. Std. .040 .080	12.2:1 Comp. 5220A 5220B 5224	12.25:1 Comp. 4713M09000	12.2:1 Comp. 8563DA 8563DB	11.3:1 Comp. VT22951A VT22951B	12:1 Comp. 180297		Top End C7978-EST	Top End 35-3402 Complete with Oil Seals 37-3402	Cylinder Works 40001 (Std. 90mm) Cylinder Works Complete Kit 40001-K01 (Std. 90mm)	Steel Exhaust 28-34021 O/S+ 1mm 60-60054H Steel Intake 28-34022 O/S+ 1mm 60-60051H Valve Spring Kit 60-60045	Valve Guide IN / EX 60-60060 Valve Seals Pkg. of 4 71015-4	Hot Cams Camshaft 2249-1IN (Intake) 2250-1E (Exhaust)	CC-3403	HR4059 (00-09)	Pro-X 04921 (00-20) Hot Rods HR8630	6306RI 49-822193	Bearing / Seal Kit (00-20) 49K049				
DR-Z 400 E, S	2000-13	BB	FL-5430B																							
434cc 94mm 3.700" 440cc 94.50mm 443cc 95.00mm 450cc 95.50mm <i>COMPLETE CYLINDER KIT INCLUDES BIG BORE CYLINDER, PISTON KIT AND TOP END GASKETS</i>				94.00 94.50	.160 .180	12.5:1 Comp. 4795M09450	12:1 Comp. 8563D400	11.3:1 Comp. VT23533A	12:1 Comp. 183051			Top End C7979-EST (94mm) C3138-EST (96mm) GS5430 (97mm)	Cylinder Works Plated Bore 41001-1 (434cc, 94mm) Cylinder Works Complete Kit 41001-K01 (434cc, 94mm)													
RMZ-450	2005	AC	FL-5601	5628K																						
RMZ-450 2006-07 449cc Liquid Cooled 95.5mm 3.760" <i>RESLEEVING REQUIRED FOR OVERSIZES</i>		AC	FL-5628																							
				95.50 95.51 97.50	Std. Std. .080	12:1 Comp. 5230A 5230B 5238	12:1 Comp. 4869M09550	12:1 Comp. 8606DA 8606DB	12:1 Comp. VT23198A VT23198B	12:8:1 Comp. 247591		Top End C3102-EST C3104-EST (97.5mm) C3127-EST (98mm)	Top End 35-3405 Complete with Oil Seals 37-3405	2005-06 Titanium Exhaust 28-34051 Titanium Intake 28-34052 Kibblewhite Steel Exhaust 60-60273H Steel Intake 60-60270H Valve Spring Kit 60-60240 2007 Titanium Exhaust 28-34071 Titanium Intake 28-34072 Valve Spring Kit 60-60650	Valve Guide IN / EX (05-06) 60-60320 2007 60-60670	Hot Cams Camshaft 2005-06 2052-1IN (Intake) 2053-1E (Exhaust) 2007 Stage 1 2081-1IN (Intake) 2082-1E (Exhaust) Stage 2 2083-2IN (Intake) 2084-2E (Exhaust)	CC-3407	Pro-X 04914 Hot Rods HR8647	49-822318	Bearing / Seal Kit 49K050						

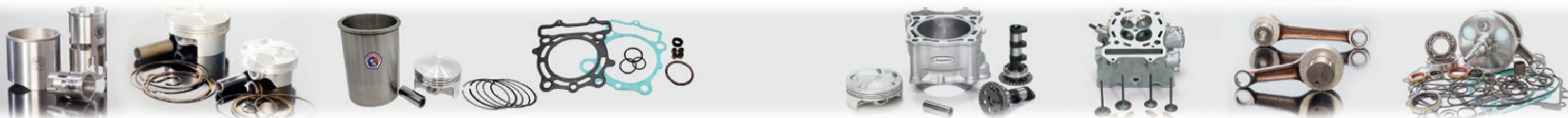

GASGAS HONDA HUSQVARNA KAWASAKI KTM SUZUKI YAMAHA DIRT BIKE SLEEVES STREET BIKE SLEEVES ACCESSORIES TECHNICAL



MODEL
Engine Description
Cylinder I.D. (mm/in.)



SLEEVE

REBUILD KIT
Sleeve • Piston
Gasket • T.E. Bearing

BORE SIZE
(mm)

PISTON SIZE

TOP END

TOP END

VALVE TRAIN

BOTTOM END

PRO-X PISTON

WISECO PISTON

WOSSNER PISTON

VERTEX PISTON

JE PISTON

COMETIC GASKET

L.A. SLEEVE GASKET

CYLINDER AFTERMARKET KITS

VALVE / SPRING KIT

VALVE GUIDE

CAMSHAFT

CAM CHAIN

CRANKSHAFT

CON-ROD KIT

CRANK BEARING

ENGINE OIL SEAL KIT

BOTTOM END KIT
Crankshaft • Bearings • Seals • Gasket Set

SUZUKI FOUR-STROKE (CONTINUED)

RM-Z450 2008-12 449cc Liquid Cooled 96mm 3.780" <i>RESLEEVEING REQUIRED FOR OVERSIZES</i>	AC	FL-5699	5699K	96.00	Std.	12.2:1 Comp. 01.3408A	12.2:1 Comp. 4953M09600	12.2:1 Comp. 8716DA 8716DB	12.2:1 Comp. VT23377A VT2377B	13:1 Comp. 274180	Top End C3233-EST			Top End 35-0595		Pro-X Titanium Exhaust 28-34081	Valve Guide IN / EX 60-60730	Hot Cams Camshaft Stage 1 2266-1IN (Intake)	CC-3407		Pro-X 03.3408	49-822346	Bearing / Seal Kit 49K058		
				96.01	Std.	13.2:1 comp. 01.3409A	13.2:1 Comp. 4954M09600	13.5:1 Comp. 8717DA	12.9:1 Comp. VT2378A	13.5:1 Comp. 274181														Complete w/ oil seals 37-1595	Titanium Intake 28-34082
RM-Z450 2013-23 449cc Liquid Cooled 96mm 3.780"	AC	FL-5699		96.00	Std.	(13-23) 12.5:1 comp. 01.3413A	(13-23) 12.5:1 comp. 40086M09600	(13-18) 12.5:1 Comp. 8886DA 8886DB	(13-17) 12.5:1 Comp. VT23863A VT23863B	(13-23) 13:1 Comp. 317238	Top End C3233-EST			Top End 35-0595		Pro-X Titanium Exhaust 28-34081	Valve Guide IN / EX 60-60730		CC-3407		Pro-X 04914	49-822346 (13-20)	Bearing / Seal Kit (13-20) 49K058		
				96.01	Std.	01.3413B		12.7:1 comp. 8756DA	12.5:1 comp. VT24284A															Complete w/ oil seals (13-20) 37-1595	Titanium Intake 28-34082
DR, SP-600, Djebel 1985-89 589cc Single 94mm 3.701"	RS/MO	FL-871		95.00	.040		9.7:1 Comp. 4597M09500 4597M09600 4597M09700																		
				96.00	.080																				
				97.00	.120																				
LS-650 1986-98 640cc Single 95mm 3.740"	RS/L	FL-5219		95.00	Std.		9.7:1 Comp. 4597M09500 4597M09600 4597M09700																		
				96.00	.040																				
				97.00	.080																				
DR-650 1990-95 640cc Single 95mm 3.740"	RS/L	FL-5219		95.00	Std.		9.7:1 Comp. 4597M09500 4597M09600 4597M09700																		
				96.00	.040																				
				97.00	.080																				
DR-650 SE, S 1996-24 644cc Single 100mm 3.937"	AC	FL-5309		100.00	Std.			10.5:1 Comp. 8591DA 8591DB		10.5:1 Comp. 136633				Top End 35-0586											
				100.01	Std.																				
V-Strom 650 2004-24 645cc V-Twin Liquid-Cooled 81mm 3.188"	AC	FL-5421		81.00	Std.																				
V-Strom 650 Big Bore to 744cc 2004-24 87mm 3.425"	BB	FL-5421B		87.00	.240																				
V-Strom 1000 2003-12 996cc V-Twin Liquid-Cooled 98mm 3.858"	AC	FL-5460		98.00	Std.																				





MODEL
Engine Description
Cylinder I.D. (mm/in.)



SLEEVE

REBUILD KIT
Sleeve - Piston
Gasket - T.E. Bearing

BORE SIZE (mm)

PISTON SIZE

TOP END

TOP END

BOTTOM END

PRO-X PISTON

WISECO PISTON

WOSSNER PISTON

VERTEX PISTON

T.E. BEARING

COMETIC GASKET

L.A. SLEEVE GASKET

CRANKSHAFT

CON-ROD KIT

CON-ROD ASSEMBLY
Rod - Bearings - Seals

CRANK BEARING

CRANK SEAL KIT

BOTTOM END KIT
Crankshaft - Bearings - Seals - Gasket Set

YAMAHA TWO-STROKE

PW-50 All Years QT-50 All Years MJ-50 All Years 49cc 40mm 1.574"				40.00 40.50 41.00 41.50 42.00	Std. .020 .040 .060 .080	7260 7262 7264	653M04000 653M04050 653M04100 653M04150 653M04200	8267DA 8267D050 8267D100 8267D150 8267D200			T.E. Bearing B1084	Top End C7266 (PW)	Top End 35-0601 Complete with Oil Seals 37-1601 (PW)		Pro-X 32008		6205C3	092005			
PW-80 All Years BW-80 79cc 47mm 1.850"				47.00 47.25 47.50 47.75 48.00 48.50 49.00	Std. .010 .020 .030 .040 .060 .080	7270 7271 7272 7273 7274	649M04700 649M04750 649M04800 649M04850 649M04900	8233DA 8233D050 8233D100 8233D150			T.E. Bearing B1042	Top End C7251	Thru '06 Top End 35-0615 Complete with Oil Seals 37-1615 (PW)		Pro-X 04991		6205C3	092008			
YZ-65 (No. BR8) 65cc 43.5mm 1.712" CYLINDER SLEEVING REQUIRED FOR OVERSIZES	2018-24	AC	YA-5806	5806K	43.50 43.51	Std. Std.	01.2018A 01.2018B	885M04350	8306DA 8306DB	VT24352A VT24352B			T.E. Bearing WB104	Top End C3694	Top End 35-2018		Pro-X 03.2018		Pro-X Bearing / Seal Kit 49-20018 Hot Rods Bearing / Seal Kit 49K00059		
YZ-80 L (No. 39K) 82.5cc 48mm 1.890"	1984	CS/MO	YA-888H		48.00 48.50 49.00	Std. .020 .040			8214DA 8214D050 8214D100				T.E. Bearing 01203	Top End C7106				6204C3	094280	Bearing / Seal Kit 496204	
YZ-80 N (No. 58T) 82.5cc 48mm 1.890"	1985	CS/MO	YA-888H		48.00 48.50 49.00 49.50 50.00	Std. .020 .040 .060 .080		520M04800 520M04850 520M04900 520M04950 520M05000	8186DA 8186D050 8186D100 8186D150 8186D200				T.E. Bearing 01203	Top End C7076				6204C3	094280	Bearing / Seal Kit 496204	
YZ-80 S (No. 1LR) 82.5cc 48mm 1.890"	1986	CI/MO	YA-978		48.00 48.50 49.00 49.50 50.00	Std. .020 .040 .060 .080		520M04800 520M04850 520M04900 520M04950 520M05000	8186DA 8186D050 8186D100 8186D150 8186D200				T.E. Bearing 01203	Top End C7080	Top End 35-0612 Complete with Oil Seals 37-1612			6204C3	094280	Bearing / Seal Kit 496204	
YZ-80 T (No. 2HF) 82.5cc 48mm 1.890"	1987	CI/L	YA-5056		48.00 48.50 49.00 49.50 50.00	Std. .020 .040 .060 .080		520M04800 520M04850 520M04900 520M04950 520M05000	8186DA 8186D050 8186D100 8186D150 8186D200				T.E. Bearing 01203	Top End C7080	Top End 35-0612 Complete with Oil Seals 37-1612			6204C3	094280	Bearing / Seal Kit 496204	
YZ-80 V, W, B 82.5cc 48mm 1.890"	1988-92	CI/L	YA-5056		48.00 48.50 49.00 49.50 50.00	Std. .020 .040 .060 .080		569M04800 569M04850 569M04900 569M04950 569M05000	8187DA 8187D050 8187D100 8187D150 8187D200				T.E. Bearing 01203	Top End C7080	Top End 35-0612 Complete with Oil Seals 37-1612			6204C3	094280	Bearing / Seal Kit 496204	
YZ-80 (No. 4ES) 82.5cc 47mm 1.850" CYLINDER SLEEVING REQUIRED FOR OVERSIZES	1993-01	AC	YA-5183	5183K	47.00 47.50 48.00 48.50 49.00	Std. .020 .040 .060 .080	7109B/C	646M04700 646M04750 646M04800 646M04850 646M04900	8188DA 8188D050 8188D100 8188D150 8188D200				T.E. Bearing 01403	Top End C7137	Top End 35-2113 Complete with Oil Seals 37-2113	HR4033	Pro-X 04979 Hot Rods HR8126	39-4979	Left 6204C3 Right 6304C3	094280	Hot Rods CBK0075 Bearing / Seal Kit 494280





MODEL
Engine Description
Cylinder I.D. (mm/in.)



SLEEVE

REBUILD KIT
Sleeve - Piston
Gasket - T.E. Bearing

BORE SIZE (mm)

PISTON SIZE

TOP END

TOP END

BOTTOM END

PRO-X PISTON

WISECO PISTON

WOSSNER PISTON

VERTEX PISTON

T.E. BEARING

COMETIC GASKET

L.A. SLEEVE GASKET

CRANKSHAFT

CON-ROD KIT

CON-ROD ASSEMBLY
Rod - Bearings - Seals

CRANK BEARING

CRANK SEAL KIT

BOTTOM END KIT
Crankshaft - Bearings - Seals - Gasket - Set

YAMAHA TWO-STROKE (CONTINUED)

MODEL	Year	AC	YA	Sleeve	Bores	Piston	PRO-X PISTON	WISECO PISTON	WOSSNER PISTON	VERTEX PISTON	T.E. BEARING	COMETIC GASKET	L.A. SLEEVE GASKET	CRANKSHAFT	CON-ROD KIT	CON-ROD ASSEMBLY	CRANK BEARING	CRANK SEAL KIT	BOTTOM END KIT
YZ-85 (No. 5PA) 85cc Liquid Cooled 47.5mm 1.870"	2002-18	AC	YA-5476	5476K	47.50 47.51 48.00 48.50 49.00	Std. Std. .020 .040 .080	2112A 2112B	805M04750 805M04800 805M04850 805M04950	8104DA 8104DB	VT24370A VT24370B VT22871200	T.E. Bearing 01403	Top End C7851	Top End 35-2112 Complete with Oil Seals 37-2112	HR4034	Pro-X 04979 Hot Rods HR8126	39-4979	Left 6204C3 Right 6304C3	094280	Hot Rods CBK0076
YZ-85 (No. B4B) 85cc Liquid Cooled 47.5mm 1.870"	2019-24	AC	YA-5807	5807K	47.50 47.51 48.00 48.50 49.50	Std. Std. .020 .040 .080	2112A 2112B	805M04750 805M04800 805M04850 805M04900	8104DA 8104DB	VT24370A VT24370B	T.E. Bearing 01154	Top End C3731	Top End 35-2022 Complete with Oil Seals 37-2026		Pro-X 03.2119	39-2119	Pro-X Bearing / Seal Kit 49-20018		
YZ-125 V (No. 3JD) 123cc Liquid Cooled 56mm 2.205"	1989	AC	YA-5094	5094K	56.00 56.50 57.00	Std. .020 .040		582M05600 582M05650 582M05700	8131DA 8131D050 8131D100		T.E. Bearing 01202	Top End C7083			Pro-X 04994	39-4994	6322X	094283	Bearing / Seal Kit 494283
YZ-125 W (No. 3SR) 124cc Liquid Cooled 56mm 2.205"	1990	AC	YA-5120	5120K	56.00 56.50 57.00	Std. .020 .040	7210D	594M05600 594M05650 594M05700	8114DA 8114D050 8114D100		T.E. Bearing 01202	Top End C7084			Pro-X 04994	39-4994	6322X	094283	Bearing / Seal Kit 494283
YZ-125 B-1 (No. 3XJ) 124cc Liquid Cooled 56mm 2.205"	1991	AC	YA-5118	5118K	56.00 56.50 57.00	Std. .020 .040	7210D	594M05600 594M05650 594M05700	8114DA 8114D050 8114D100		T.E. Bearing 01202	Top End C7084			Pro-X 04994	39-4994	6322X	094283	Bearing / Seal Kit 494283
YZ-125 YPVS (No. 4DB) 124cc Liquid Cooled 56mm 2.205"	1992	AC	YA-5141	5141K	56.00 56.50 57.00	Std. .020 .040	7210D	594M05600 594M05650 594M05700	8114DA 8114D050 8114D100		T.E. Bearing 01202	Top End C7139	Complete with Oil Seals 37-1634		Pro-X 04994	39-4994	6322X	094283	Bearing / Seal Kit 494283
YZ-125 (No. 4EX) 124cc Liquid Cooled 56mm 2.205"	1993	AC	YA-5184	5184K	56.00 56.50 57.00	Std. .020 .040	7210D	629M05600 629M05750 629M05700	8114DA 8114D050 8114D100		T.E. Bearing 01202	Top End C7139	Complete with Oil Seals 37-1635		Pro-X 04994	39-4994	6322X	094283	Bearing / Seal Kit 494283
YZ-125 (No. 4JY, 4PE) 124cc Liquid Cooled 54mm 2.126"	1994-95	AC	YA-5257	5257K	54.00 54.01 54.50 55.00 56.00	Std. Std. .020 .040 .080	7214B 7214C	647M05400 647M05450 647M05500 647M05600	8116DA 8116D050 8116D100 8116D200		T.E. Bearing 01202	Top End C7158	Top End 35-2214 Complete with Oil Seals 37-2214		Pro-X 04994	39-4994	6322X	094283	Bearing / Seal Kit 494283

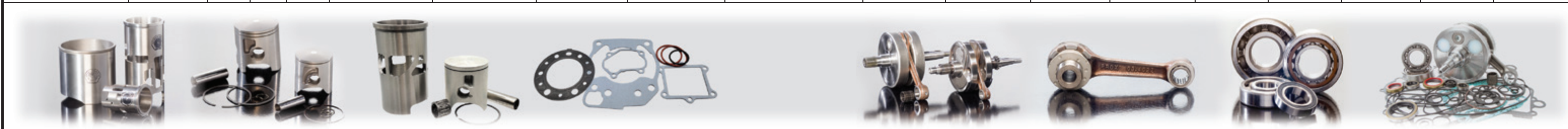

GASGAS
HONDA
HUSQVARNA
KAWASAKI
KTM
SUZUKI
YAMAHA
DIRT BIKE SLEEVES
STREET BIKE SLEEVES
ACCESSORIES
TECHNICAL



MODEL
Engine Description
Cylinder I.D. (mm/in.)



SLEEVE

REBUILD KIT
Sleeve - Piston
Gasket - T.E. Bearing

BORE SIZE (mm)

PISTON SIZE

TOP END

TOP END

BOTTOM END

PRO-X PISTON

WISECO PISTON

WOSSNER PISTON

VERTEX PISTON

T.E. BEARING

COMETIC GASKET

L.A. SLEEVE GASKET

CRANKSHAFT

CON-ROD KIT

CON-ROD ASSEMBLY
Rod - Bearings - Seals

CRANK BEARING

CRANK SEAL KIT

BOTTOM END KIT
Crankshaft - Bearings - Seals - Gasket Set

YAMAHA TWO-STROKE (CONTINUED)

YZ-125 (No. 4SS) 124cc Liquid Cooled 54mm 2.126"	1996	AC	YA-5348	5311K	54.00 54.01 54.50 55.00 56.00	Std. Std. .020 .040 .080	7214B 7214C	647M05400 647M05450 647M05500 647M05600	8116DA 8116D050 8116D100 8116D200			T.E. Bearing 01202	Top End C7158	Top End 35-2214 Complete with Oil Seals 37-2214	HR4035	Pro-X 04994	39-4994	6322X Bearing / Seal Kit 494283	094283	
YZ-125 (No. 4SS) 124cc Liquid Cooled 54mm 2.126"	1997	AC	YA-5348	5311K-1	54.00 54.01 55.00 56.00	Std. Std. .040 .080	7215A 7215B 7215F100	693M05400	8117DA 8117D200			T.E. Bearing 01205	Top End C7158	Top End 35-2214 Complete with Oil Seals 37-2214	HR4035	Pro-X 04990	39-4994X	6322X Bearing / Seal Kit 494283	094283	
YZ-125 (No. 4SS) 124cc Liquid Cooled 54mm 2.126"	1998	AC	YA-5348	5348K	54.00 54.01 54.50 55.00 56.00	Std. Std. .020 .040 .080	7215A 7215B 7215F100	726M05400 726M05500 726M05600	8091DA 8091DB 8091D050 8091D100 8091D200			T.E. Bearing 01205 (98-00)	Top End C7399	Top End 35-2218 Complete with Oil Seals 37-2218	HR4035	Pro-X 04990	39-4990	6322X Bearing / Seal Kit 494286	094286	Hot Rods CBK0013
YZ-125 (5ET, 5HD, 5MV) 124cc Liquid Cooled 54mm 2.126"	1999-01	AC	YA-5378	5378K (99-00) 5378K-1 (01)	54.00 54.01 54.50 55.00 56.00	Std. Std. .020 .040 .080	7215A 7215B 7215F100	726M05400 726M05500 726M05600	8091DA 8091DB 8091D050 8091D100 8091D200			T.E. Bearing 01205 (99-00) 01152 (01)	Top End C7399 (99-00) C7853 (01)	Top End 35-2218 Complete with Oil Seals 37-2218 (99-00)	HR4035 (98-00) HR4036 (01)	Pro-X 04990 (99-00) 04920 (01)	39-4990 (99-00) 39-4920 (01)	6322X Bearing / Seal Kit 494286 (99-00)	094286 (99-00) 094290 (01)	Hot Rods CBK0013 (99-00) CBK0077 (01)
YZ-125 (No. 5NY) 124cc Liquid Cooled 54mm 2.126"	2002	AC	YA-5470	5470K	54.00 54.01 54.50 55.00 56.00	Std. Std. .020 .040 .080	2222A 2222B	797M05400 797M05450 797M05500 797M05600	8072DA 8072DB 8072D200			T.E. Bearing 01152	Top End C7853	Top End 35-2222 Complete with Oil Seals 37-2222	HR4036	Pro-X 04920	39-4920	6322X Bearing / Seal Kit 494290 (01-02)	094290	Hot Rods CBK0014
YZ-125 (No. 5UN) 124cc Liquid Cooled 54mm 2.126"	2003	AC	YA-5487	5487K	54.00 54.01 54.50 55.00 56.00	Std. Std. .020 .040 .080	2222A 2222B	797M05400 797M05450 797M05500 797M05600	8072DA 8072DB 8072D200			T.E. Bearing 01152	Top End C7936	Top End 35-2222 Complete with Oil Seals 37-2222	HR4036	Pro-X 04920	39-4920	6322X Bearing / Seal Kit 494290	094290	Hot Rods CBK0014
YZ-125 (No. 5XE) 124cc Liquid Cooled 54mm 2.126"	2004	AC	YA-5533	5533K	54.00 54.01 54.50 55.00 56.00	Std. Std. .020 .040 .080	2222A 2222B	797M05400 797M05450 797M05500 797M05600	8072DA 8072DB 8072D200			T.E. Bearing 01152	Top End C7936	Top End 35-2222 Complete with Oil Seals 37-2222	HR4036	Pro-X 04920	39-4920	6322X Bearing / Seal Kit 494290	094290	Hot Rods CBK0014
YZ-125 (No. 1C3) 124cc Liquid Cooled 54mm 2.126"	2005-21 2020-22	AC	YA-5533	5533K-1	54.00 54.01 56.00	Std. Std. .080	2225A 2225B	845M05400 845M05600	8160DA 8160DB 8160D200	VT23119A VT23119B		T.E. Bearing 01152	Top End C3105	Top End 35-2225 Complete with Oil Seals 37-2225	HR4054	Pro-X 04916	39-4916	6322X	42.2225	Hot Rods CBK0090
YZ-125 Big Bore to 144cc 58mm 2.283"	2005-21	AC	YA-5533B		58.00	.160		846M05800	8160D400			T.E. Bearing 01152	Top End C3105	Top End 35-2225 Complete with Oil Seals 37-2225						

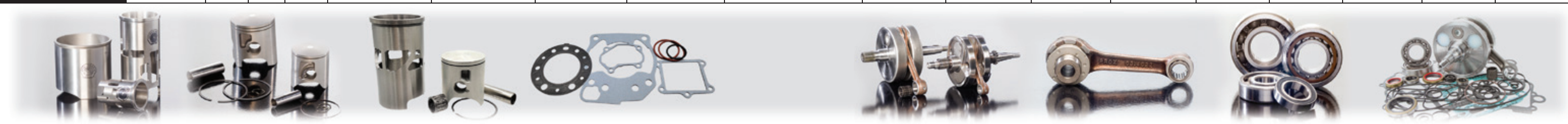

GASGAS
HONDA
HUSQVARNA
KAWASAKI
KTM
SUZUKI
YAMAHA
DIRT BIKE SLEEVES
STREET BIKE SLEEVES
ACCESSORIES
TECHNICAL



MODEL
Engine Description
Cylinder I.D. (mm/in.)



SLEEVE

REBUILD KIT
Sleeve - Piston
Gasket - T.E. Bearing

BORE SIZE (mm)

PISTON SIZE

TOP END

TOP END

BOTTOM END

PRO-X PISTON

WISECO PISTON

WOSSNER PISTON

VERTEX PISTON

T.E. BEARING

COMETIC GASKET

L.A. SLEEVE GASKET

CRANKSHAFT

CON-ROD KIT

CON-ROD ASSEMBLY
Rod • Bearings • Seals

CRANK BEARING

CRANK SEAL KIT

BOTTOM END KIT
Crankshaft • Bearings • Seals • Gasket Set

YAMAHA TWO-STROKE (CONTINUED)

YZ-125 YZ-125X (No. B4X) 124cc Liquid Cooled 54mm 2.126"	2022-24	AC	YA-5857	5857K	54.00 Std. 54.01 Std. 56.00 .080	2232A 2232B	899M05400 899M05600	8331DA 8331DB	VT24570B		T.E. Bearing 01152	Top End C3215	Top End 35-2060 Complete with Oil Seals 37-2054		Pro-X 03.2232	39-2232	6322X 42.2225 Bearing / Seal Kit 49-22005	
RT-180 (No. 5L9) 176cc Single 64.5mm 2.539"	1990-98	CI	YA-5134		64.50 Std. 65.00 .020 65.50 .040		772M06450 772M06500 772M06550											
DT-200 YVPS (No. 3ET) 195cc Liquid Cooled Case Reed 66mm 2.598"	1990-92	CI	YA-5162		66.00 Std. 66.50 .020 67.00 .040 67.50 .060 68.00 .080		599M06600 599M06650 599M06700 599M06750 599M06800				T.E. Bearing 01310	Top End C7142						
WR-200 (No. 3XP) 223cc Single 66.8mm 2.630"	1991-95	AC	YA-5137		66.80 Std. 67.00 .008 67.50 .028 68.00 .047 68.50 .067		818M06680 818M06700 818M06850	8070D080 8070D100 8070D150 8070D200 8070D250				Top End C7142					6305RI 094963 (92)	
YZ-250 K (No. 24Y) 246cc Liquid Cooled 68mm 2.677"	1983	CI MO	YA-810		68.00 Std. 68.25 .010 68.50 .020 68.75 .030 69.00 .040 69.25 .050 69.50 .060 69.75 .070 70.00 .080	2642 2646 2647 2637 2638	560M06800 560M06850 560M06900 560M06950 560M07000	8133DA 8133D050 8133D100			T.E. Bearing 01251		Top End 35-0060 Complete with Oil Seals 37-1660	Pro-X 04981 Hot Rods HR8106 Wossner WR2048	39-4284B	6206C3 094284 Bearing / Seal Kit 494284		
YZ-250 L (No. 39X) 246cc Liquid Cooled 68mm 2.677"	1984	CS MO	YA-877		68.00 Std. 68.25 .010 68.50 .020 68.75 .030 69.00 .040 69.25 .050 69.50 .060 69.75 .070 70.00 .080	2642 2646 2647 2637 2638	560M06800 560M06850 560M06900 560M06950 560M07000	8133DA 8133D050 8133D100			T.E. Bearing 01251		Top End 35-0060 Complete with Oil Seals 37-1660	Pro-X 04981 Hot Rods HR8106 Wossner WR2048	39-4284B	6206C3 094284 Bearing / Seal Kit 494284		
YZ-250 N (No. 56A) 246cc Liquid Cooled 68mm 2.677"	1985	CS MO	YA-878		68.00 Std. 68.25 .010 68.50 .020 68.75 .030 69.00 .040 69.25 .050 69.50 .060 69.75 .070 70.00 .080	2642 2646 2647 2637 2638	560M06800 560M06850 560M06900 560M06950 560M07000	8133DA 8133D050 8133D100			T.E. Bearing 01251		Top End 35-0060 Complete with Oil Seals 37-1660	Pro-X 04981 Hot Rods HR8106 Wossner WR2048	39-4284B	6206C3 094284 Bearing / Seal Kit 494284		



GASGAS
HONDA
HUSQVARNA
KAWASAKI
KTM
SUZUKI
YAMAHA
DIRT BIKE SLEEVES
STREET BIKE SLEEVES
ACCESSORIES
TECHNICAL



MODEL
Engine Description
Cylinder I.D. (mm/in.)



SLEEVE

REBUILD KIT
Sleeve - Piston
Gasket - T.E. Bearing

BORE SIZE (mm)

PISTON SIZE

TOP END

TOP END

BOTTOM END

PRO-X PISTON

WISECO PISTON

WOSSNER PISTON

VERTEX PISTON

T.E. BEARING

COMETIC GASKET

L.A. SLEEVE GASKET

CRANKSHAFT

CON-ROD KIT

CON-ROD ASSEMBLY
Rod - Bearings - Seals

CRANK BEARING

CRANK SEAL KIT

BOTTOM END KIT
Crankshaft - Bearings - Seals - Gasket Set

YAMAHA TWO-STROKE (CONTINUED)

MODEL	Engine Description	Cylinder I.D. (mm/in.)	SLEEVE	REBUILD KIT	BORE SIZE (mm)	PISTON SIZE	PRO-X PISTON	WISECO PISTON	WOSSNER PISTON	VERTEX PISTON	T.E. BEARING	COMETIC GASKET	L.A. SLEEVE GASKET	CRANKSHAFT	CON-ROD KIT	CON-ROD ASSEMBLY	CRANK BEARING	CRANK SEAL KIT	BOTTOM END KIT
YZ-250 S (No. 1LU) 246cc Liquid Cooled 68mm 2.677"	1986	CS/L	YA-980		68.00 Std. 68.25 .010 68.50 .020 68.75 .030 69.00 .040 69.25 .050 69.50 .060 69.75 .070 70.00 .080		2642	560M06800 560M06850 560M06900 560M06950 560M07000	8133DA 8133D050 8133D100		T.E. Bearing 01251	Top End C7086	Top End 35-0061 Complete with Oil Seals 37-1661		Pro-X 04981 Hot Rods HR8106 Wossner WR2048	39-4284B	6206C3 Bearing / Seal Kit 494284	094284	
YZ-250 T (No. 2HH) 246cc Liquid Cooled 68mm 2.677"	1987	CS/L	YA-5015		68.00 Std. 68.25 .010 68.50 .020 68.75 .030 69.00 .040 69.25 .050 69.50 .060 69.75 .070 70.00 .080		2642	560M06800 560M06850 560M06900 560M06950 560M07000	8133DA 8133D050 8133D100		T.E. Bearing 01251	Top End C7086	Top End 35-0661 Complete with Oil Seals 37-1661		Pro-X 04981 Hot Rods HR8106 Wossner WR2048	39-4284B	6206C3 Bearing / Seal Kit 494284	094284	
YZ-250 U (No. 2VM) 246cc Liquid Cooled 68mm 2.677"	1988	CS	YA-5054	5054K	68.00 Std. 68.50 .020 69.00 .040 69.25 .050 69.50 .060 70.00 .080		7080B 7072 7074 7075	605M06800 605M06850 605M06900 605M06950 605M07000	8134DA 8134D050 8134D100 8134D150 8134D200		T.E. Bearing 01251	Top End C7087	Top End 35-0659 Complete with Oil Seals 37-1662		Pro-X 04981 Hot Rods HR8106 Wossner WR2048	39-4281	6328C3 Bearing / Seal Kit 494285	094285	
YZ-250 V (No. 3JE) WR-250 246cc Liquid Cooled 68mm 2.677"	1989	CS	YA-5095	5095K	68.00 Std. 68.50 .020 69.00 .040 69.25 .050 69.50 .060 70.00 .080		7080B 7072 7074 7075	605M06800 605M06850 605M06900 605M06950 605M07000	8134DA 8134D050 8134D100 8134D150 8134D200		T.E. Bearing 01251	Top End C7088	Top End 35-0659 Complete with Oil Seals 37-1662		Pro-X 04981 Hot Rods HR8106 Wossner WR2048	39-4281	6328C3 Bearing / Seal Kit 494285	094285	
YZ-250 W (No. 3SP) WR-250 246cc Liquid Cooled 68mm 2.677"	1990	CS	YA-5109	5109K	68.00 Std. 68.50 .020 69.00 .040 69.25 .050 69.50 .060 70.00 .080		7080B 7072 7074 7075	605M06800 605M06850 605M06900 605M06950 605M07000	8134DA 8134D050 8134D100 8134D150 8134D200		T.E. Bearing 01251	Top End C7088	Top End 35-0663 Complete with Oil Seals 37-1663		Pro-X 04968 Hot Rods HR8107 Wossner WR2029	39-4968	6328C3 Bearing / Seal Kit 494285	094285	
YZ-250 B-1 (No. 3XK) WR-250 246cc Liquid Cooled 68mm 2.677"	1991	AC	YA-5119	5119K	68.00 Std. 68.50 .020 69.00 .040 69.25 .050 69.50 .060 70.00 .080		7080B 7072 7074 7075	605M06800 605M06850 605M06900 605M06950 605M07000	8134DA 8134D050 8134D100 8134D150 8134D200		T.E. Bearing 01251	Top End C7089	Top End 35-0663 Complete with Oil Seals 37-1663		Pro-X 04968 Hot Rods HR8107 Wossner WR2029	39-4968	6328C3 Bearing / Seal Kit 494285	094285	



GASGAS
HONDA
HUSQVARNA
KAWASAKI
KTM
SUZUKI
YAMAHA
DIRT BIKE SLEEVES
STREET BIKE SLEEVES
ACCESSORIES
TECHNICAL



MODEL
Engine Description
Cylinder I.D. (mm/in.)



SLEEVE

REBUILD KIT
Sleeve - Piston
Gasket - T.E. Bearing

BORE SIZE (mm)

PISTON SIZE

TOP END

TOP END

BOTTOM END

PRO-X PISTON

WISECO PISTON

WOSSNER PISTON

VERTEX PISTON

T.E. BEARING

COMETIC GASKET

L.A. SLEEVE GASKET

CRANKSHAFT

CON-ROD KIT

CON-ROD ASSEMBLY
Rod - Bearings - Seals

CRANK BEARING

CRANK SEAL KIT

BOTTOM END KIT
Crankshaft - Bearings - Seals - Gasket Set

YAMAHA TWO-STROKE (CONTINUED)

MODEL	Year	AC	YA	Part No.	68.00	Std.	7080B	677M06800	8023DA			T.E. Bearing	Top End	Top End		Pro-X	39-4968	6328C3	094285	
YZ-250 (No. 4DA) WR-250 249cc Liquid Cooled 68mm 2.677"	1992	AC	YA-5174	5174K	68.00 68.50 69.00 69.25 70.00	.020 .040 .050 .080	7080B 7072 7074 7075	677M06800 677M06850 677M06900 677M07000	8023DA 8023D050 8023D100 8023D200			T.E. Bearing 01251	Top End C7089	Top End 37-0664 Complete with Oil Seals 37-1664		Pro-X 04968 Hot Rods HR8107 Wossner WR2029		Bearing / Seal Kit 494285		
YZ-250 (No. 4EW) WR-250 249cc Liquid Cooled 68mm 2.677"	1993	AC	YA-5185	5185K	68.00 68.50 69.00 69.25 70.00	.020 .040 .050 .080	7080B 7072 7074 7075	677M06800 677M06850 677M06900 677M07000	8023DA 8023D050 8023D100 8023D200			T.E. Bearing 01251	Top End C7089	Top End 37-0664 Complete with Oil Seals 37-1664		Pro-X 04968 Hot Rods HR8107 Wossner WR2029		Bearing / Seal Kit 494285		
YZ-250 (No. 4JX, 4MX) 249cc Liquid Cooled 68mm 2.677"	1994-95	AC	YA-5258	5222K (94) 5258K (95)	68.00 68.50 69.00 69.25 70.00	.020 .040 .050 .080	7080B 7072 7074 7075	677M06800 677M06850 677M06900 677M07000	8023DA 8023D050 8023D100 8023D200			T.E. Bearing 01251	Top End C7089 (94) C7250 (95)	Top End 35-0664 (94) 35-2315 (95) Complete with Oil Seals 37-1664 (94)		Pro-X 04968 Hot Rods HR8107 Wossner WR2029		Bearing / Seal Kit 494285		
YZ-250 (No. 4SR) 249cc Liquid Cooled 68mm 2.677"	1996	AC	YA-5296	5296K	68.00 68.50 69.00 69.25 70.00	.020 .040 .050 .080	7080B 7072 7074 7075	677M06800 677M06850 677M06900 677M07000	8023DA 8023D050 8023D100 8023D200			T.E. Bearing 01251	Top End C7250	Top End 35-2315 Complete with Oil Seals 37-2315 (95-96)		Pro-X 04968 Hot Rods HR8107 Wossner WR2029		Bearing / Seal Kit 494285		
YZ-250 (No. 4XL) 249cc Liquid Cooled 68mm 2.677"	1997	AC	YA-5327	5327K	68.00 68.50 69.00 69.25 70.00	.020 .040 .050 .080	7080B 7072 7074 7075	677M06800 677M06850 677M06900 677M07000	8023DA 8023D050 8023D100 8023D200			T.E. Bearing 01251	Top End C7337	Top End 35-2317 Complete with Oil Seals 37-2317		Pro-X 04968 Hot Rods HR8107 Wossner WR2029		Bearing / Seal Kit 494285		
YZ-250 (No. 4XL) 249cc Liquid Cooled 68mm 2.677" <i>POWER VALVE MUST BE MODIFIED TO USE .040 OVERSIZE PISTON AND LARGER</i> CYLINDER SLEEVING REQUIRED FOR OVERSIZES	1998	AC	YA-5352	5352K	68.00 68.50 69.00 69.25 70.00	.020 .040 .050 .080	7080B 7072 7074 7075	677M06800 677M06850 677M06900 677M07000	8023DA 8023D050 8023D100 8023D200			T.E. Bearing 01251	Top End C7337	Top End 35-2317 Complete with Oil Seals 37-2317		Pro-X 04968 Hot Rods HR8107 Wossner WR2029		Bearing / Seal Kit 494287		

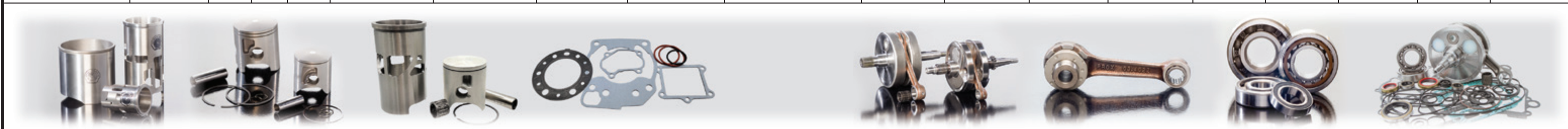

GASGAS
HONDA
HUSQVARNA
KAWASAKI
KTM
SUZUKI
YAMAHA
DIRT BIKE SLEEVES
STREET BIKE SLEEVES
ACCESSORIES
TECHNICAL



MODEL
Engine Description
Cylinder I.D. (mm/in.)



SLEEVE

REBUILD KIT
Sleeve - Piston
Gasket - T.E. Bearing

BORE SIZE (mm)

PISTON SIZE

TOP END

TOP END

BOTTOM END

PRO-X PISTON

WISECO PISTON

WOSSNER PISTON

VERTEX PISTON

T.E. BEARING

COMETIC GASKET

L.A. SLEEVE GASKET

CRANKSHAFT

CON-ROD KIT

CON-ROD ASSEMBLY
Rod - Bearings - Seals

CRANK BEARING

CRANK SEAL KIT

BOTTOM END KIT
Crankshaft - Bearings - Seals - Gasket Set

YAMAHA TWO-STROKE (CONTINUED)

YZ-250 1999-24 (5CU, 5MW, 5UP) YZ-250X 2016-24 (No. BF1) 249cc Liquid Cooled 68mm 2.677" CYLINDER SLEEVING REQUIRED FOR OVERSIZES	AC	YA-5377	5377K (99-01)	66.40	Std.	7130A	804M06640	8216DA	VT22584A		T.E. Bearing 01209	Top End C7507 (99-01) C7855 (02-23)	Top End 35-2319 (99-01) 35-2320 (02-22)	HR4037 (99-00) HR4038 (01-02) HR4138 (03-22)	Pro-X 04942 Hot Rods HR8726 Wossner WR2028	39-4288 (99-00) 39-4942 (01-23)	6328C3	094288 (99-00) 094289 (01-23)	Hot Rods CBK0078 (99-00) CBK0079 (01) CBK0015 (02) CBK0135 (03-21)
			5377K-1 (02-23)	66.41 67.00 67.50 68.50	Std. .023 .043 .083	7130B	804M06700 804M06750 804M06850	8216DB 8216D060 8216D110 8216D210	VT22584B								Complete with Oil Seals 37-2319 (99-00) 37-1669 (01) 37-2320 (02-22)	Bearing / Seal Kit 494288 (99-00) 494289 (01-23)	
WR-250 1994-97 (No. 4JX) 249cc Liquid Cooled 68mm 2.677" CYLINDER SLEEVING REQUIRED FOR OVERSIZES	AC	YA-5258		68.00	Std.	7080B	677M06800	8023DA			T.E. Bearing 01251	Top End C7089		Pro-X 04968 Hot Rods HR8107	39-4968	6328C3	094285		
				68.50 69.00 69.25 70.00	.020 .040 .050 .080	7072 7074 7075	677M06850 677M06900 677M07000	8023D050 8023D100 8023D200	Bearing / Seal Kit 494285										
WR-500 1991-93 487cc 2-Stroke 87mm 3.425"	CS	YA-5138	5138K	87.00	Std.		546M08700	8317DA			T.E. Bearing 01251	Top End C7090				6306C3	094284		
				87.50 88.00 88.50 89.00	.020 .040 .060 .080		546M08750 546M08800 546M08850 546M08900	8317D050 8317D100 8317D150 8317D200	Bearing / Seal Kit 494284										





MODEL
Engine Description
Cylinder I.D. (mm/in.)



SLEEVE

REBUILD KIT
Sleeve • Piston
Gasket • T.E. Bearing

BORE SIZE (mm)

PISTON SIZE

TOP END

TOP END

VALVE TRAIN

BOTTOM END

PRO-X PISTON

WISECO PISTON

WOSSNER PISTON

VERTEX PISTON

JE PISTON

COMETIC GASKET

L.A. SLEEVE GASKET

CYLINDER AFTERMARKET KITS

VALVE / SPRING KIT

VALVE GUIDE

CAMSHAFT

CAM CHAIN

CRANKSHAFT

CON-ROD KIT

CRANK BEARING

ENGINE OIL SEAL KIT

BOTTOM END KIT
Crankshaft • Bearings • Seals • Gasket Set

YAMAHA FOUR-STROKE

MODEL	Year	Cyl	Model	Stroke	Bore (mm)	Stroke (mm)	Compression	Piston	Gasket	Top End	Bottom End	Valve Train	Other	
TT-R90 89cc 47mm	2000-07 Single 1.850"	CI	YA-5462		47.00 47.50	Std. .020	11:1 Comp. 4840M04700 4840M04750			Top End C3249-EST		Top End 35-0616 Complete w/ oil seals		
TT-R110E 110cc 51mm	2008-24 Single 2.008"	CI	YA-5700											
TT-R125 124cc 54mm	2000-24 Single 2.126"	RS	YA-5426	5426K	54.00 54.50 55.00	Std. .020 .040	11:1 Comp. 4752M05400 4752M05450 4752M05500	11:1 Comp. 8649DA 8649D050 8649D100		Top End (00-20) C7755		Top End (00-07) 35-0640 (08-24) 35-0977 Complete w/ oil seals (00-07) 37-1640 (08-24) 37-1977	Hot Cams Camshaft 4019-1 (03-20)	49-822240
TW-200 196cc 67mm	1987-24 Single 2.638"	RS	YA-762							Top End 35-0642		(IN / EX Set) 07-301		
TT-R230 TT-R225 223cc 70mm	2005-24 1999-04 Single 2.756"	RS	YA-812		70.00 70.50 71.00	Std. .020 .040		10:1 Comp. 8933DA 8933D050 8933D100				Top End 35-0643 Complete w/ oil seals 37-1643	(IN / EX Set) 07-301	
TT-225 XT-225 223cc 70mm	1986-88 1983-00 Single 2.756"	RS	YA-812		70.00 70.50 71.00	Std. .020 .040		(92-00) 8933DA 8933D050 8933D100				Top End 35-0643 (92-00)	(IN / EX Set) 07-301	Pro-X 32325 (XT) Right 6306C3 (92-on) (XT)
XT-225 223cc 70mm	2001-07 Single 2.756"	AC	YA-5631									Top End 35-0643	(IN / EX Set) 07-301	Pro-X 32325 Right 6306C3
TT-R250 249cc 73mm	1996-06 Single 2.874"	RS	YA-5400	5400K	73.00 73.50 74.00 74.50	Std. .020 .040 .060	10.5:1 Comp. 4689M07300 4689M07350 4689M07400	10.2:1 Comp. 8646DA 8646D050 8646D100 8646D150		Top End C7726				
XT-250 249cc 74mm	2008-23 Single 2.913"	AC	YA-5702		74.00	Std.		(13-23) 12:1 Comp. 8724DA	(13-23) 10.75:1 Comp. VT23547A			Top End 35-0924		



GASGAS
HONDA
HUSQVARNA
KAWASAKI
KTM
SUZUKI
YAMAHA
DIRT BIKE SLEEVES
STREET BIKE SLEEVES
ACCESSORIES
TECHNICAL



MODEL
Engine Description
Cylinder I.D. (mm/in.)

SLEEVE	REBUILD KIT <small>Sleeve • Piston Gasket • T.E. Bearing</small>	BORE SIZE <small>(mm)</small>	PISTON SIZE	TOP END							TOP END		VALVE TRAIN				BOTTOM END				
				PRO-X PISTON	WISECO PISTON	WOSSNER PISTON	VERTEX PISTON	JE PISTON	COMETIC GASKET	L.A. SLEEVE GASKET	CYLINDER AFTERMARKET KITS	VALVE / SPRING KIT	VALVE GUIDE	CAMSHAFT	CAM CHAIN	CRANKSHAFT	CON-ROD KIT	CRANK BEARING	ENGINE OIL SEAL KIT	BOTTOM END KIT <small>Crankshaft • Bearings • Seals • Gasket Set</small>	

YAMAHA FOUR-STROKE (CONTINUED)

YZ, WR-250F (5NL) 2001-02 YZ, WR-250F (5UL) 2003 YZ, WR-250F (5XC) 2004 249cc Liquid Cooled 77mm 3.031" <i>CYL. WORKS COMPLETE KIT INCLUDES CYLINDER, PISTON, TOP END GASKETS</i>	AC	YA-5463	5463K	77.00	Std.	12.5:1 Comp. 7160A	12.5:1 Comp. 4872M07700	12.5:1 Comp. 8559DA	12.5:1 Comp. VT22805A		Top End C7905-EST		Top End 35-2401	Cylinder Works 20002 (Std. 77mm)	Titanium Exhaust 2X 28-24011	Valve Guide Intake 80-80080	Hot Cams Stage 1 4012-11N (Intake)	CC-2402	(03-04) HR4049	Pro-X 04930 (01-02)	830046	49-822175		
											C3057-EST (79mm)		Complete w/ oil seals 37-2401	Cylinder Works Complete Kit 20002-K01 (Std. 77mm)	Titanium Intake 1X 28-24012	Exhaust 80-80090	4020-1E (Exhaust)			04936 (03-04)				
															Titanium Intake 2X 28-24013	Valve Seals Pkg. of 5 80-80440	Stage 2 4054-21N (Intake)			Hot Rods HR8619 (03-04)				
YZ, WR-250F (5XC) 2005-13 249cc Liquid Cooled 77mm 3.031" <i>RESLEEVEING REQUIRED FOR OVERSIZES</i> <i>CYL. WORKS COMPLETE KIT INCLUDES CYLINDER, PISTON, TOP END GASKETS</i>	AC	YA-5536		77.00	Std.	WR-250F 12.5:1 Comp. 7160A	WR-250F 12.5:1 Comp. 4872M07700	WR-250F 12.5:1 Comp. 8559DA	WR-250F 12.5:1 Comp. VT23127A		Top End C7905-EST		Top End 35-2401	Cylinder Works 20002 (Std. 77mm)	Titanium Exhaust 2X 28-24011	Valve Guide Intake 80-80080	Hot Cams Camshaft Stage 1 4012-11N (Intake)	CC-2402	HR4049	Pro-X 04936	830046	49-822175		
						YZ-250F (05-07) 12.5:1 Comp. 7160A	YZ-250F (05-07) 12.5:1 Comp. 4882M07700	YZ-250F (05-07) 12.5:1 Comp. 8614DA	YZ-250F (05-07) 12.5:1 Comp. VT23127A	YZ-250F (05-07) 13.5:1 Comp. 247937	C3057-EST (79mm)		Complete w/ oil seals 37-2401 (YZ-F)	Cylinder Works Complete Kit YZ-250F (05-07)	Titanium Intake 1X 28-24012	Exhaust 80-80090	4020-1E (Exhaust)			Hot Rods HR8619				
						(08-11) 13.5:1 comp. 01.2409A	(08-11) 13.5:1 Comp. 4952M07700	(08-13) 13.5:1 Comp. 8712DA	(08-13) 13.5:1 Comp. VT23391A	(08-13) 13.5:1 Comp. 247937					Titanium Intake 2X 28-24013	Valve Seals Pkg. of 5 80-80440	Stage 2 4054-21N (Intake)							
						(12-13) 13.5:1 Comp. 01.2412A	(12-13) 13.5:1 Comp. 40072M07700								(08-13) 20002-K03 (Std. 77mm)	Steel Exhaust 2X 80-80077		4055-2E (Exhaust)						
YZ-250F 2014-18 YZ-250FX 2015-19 Cyl. No. 1SM 249cc Liquid Cooled 77mm 3.031" <i>CYL. WORKS COMPLETE KIT INCLUDES CYLINDER, PISTON, TOP END GASKETS</i>	AC	YA-5780		77.00	Std.	(YZ-F 14-15) (FX 15-16) 13.5:1 Comp. 01.2414A	(YZ-F 14-15) (FX 15-16) 13.5:1 Comp. 40116M07700	(YZ-F 14-15) (FX 15-16) 13.7:1 Comp. 8893DA	(YZ-F 14-15) (FX 15-16) 13.5:1 Comp. VT23941A	(YZ-F 14-15) (FX 15-16) 13.5:1 Comp. 323556	Top End C3549-EST		Top End 35-0690	Cylinder Works 20010 (Std. 77mm)	Titanium Exhaust 80-80916T	Valve Guide Intake 80-80920	Hot Cams Camshaft YZ-F (14-16) (FX 15-19)	CC-2414	Hot Rods YZ-F (14-15) HR4416	Pro-X 03.2414	830046	49-822175		
						(YZ-F 16-18) (FX 17-19) 13.5:1 Comp. 01.2417A	(YZ-F 16-18) (FX 17-19) 13.5:1 Comp. 40151M07700	(YZ-F 16-18) (FX 17-19) 13.7:1 Comp. 8942DA	(YZ-F 16-18) (FX 17-19) 13.5:1 Comp. VT24109A	(YZ-F 16-18) (FX 17-19) 13.5:1 Comp. 323556			Complete w/ oil seals 37-1690	Cylinder Works Complete Kit (14-15) 20010-K01 (Std. 77mm)	Titanium Intake 80-80912T	Exhaust 80-80930	Stage 1 4270-11N (Intake)			Hot Rods HR8717				
														(16-18) 20010-K02 (Std. 77mm)	Valve Spring Kit 80-80900	Valve Seals Pkg. of 4 80-80990	4271-1E (Exhaust)							
																	YZ-F (17-18) Stage 1 4324-11N (Intake)							
																	4325-1E (Exhaust)							

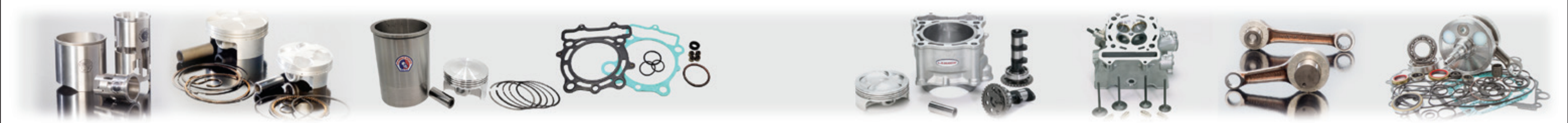

GASGAS
HONDA
HUSQVARNA
KAWASAKI
KTM
SUZUKI
YAMAHA
DIRT BIKE SLEEVES
STREET BIKE SLEEVES
ACCESSORIES
TECHNICAL



MODEL
Engine Description
Cylinder I.D. (mm/in.)



SLEEVE

REBUILD KIT
Sleeve • Piston
Gasket • T.E. Bearing

BORE SIZE (mm)

PISTON SIZE

TOP END

TOP END

VALVE TRAIN

BOTTOM END

PRO-X PISTON

WISECO PISTON

WOSSNER PISTON

VERTEX PISTON

JE PISTON

COMETIC GASKET

L.A. SLEEVE GASKET

CYLINDER AFTERMARKET KITS

VALVE / SPRING KIT

VALVE GUIDE

CAMSHAFT

CAM CHAIN

CRANKSHAFT

CON-ROD KIT

CRANK BEARING

ENGINE OIL SEAL KIT

BOTTOM END KIT
Crankshaft • Bearings • Seals • Gasket Set

YAMAHA FOUR-STROKE (CONTINUED)

MODEL	Year	AC	YA-#	Sleeve	Piston	Comp.	W.P.	W.P.	V.P.	J.P.	Gasket	Top End	Kit	Exhaust	Intake	Exhaust	Valve	Cam	CC	Pro-X	Hot Rods	Bearing / Seal Kit	Bottom End Kit	
YZ-250F YZ-250FX Cyl. No. B7B 249cc Liquid Cooled 77mm 3.031"	2019-24 2020-23	AC	YA-5780	77.00 77.01	Std. Std.	13.8:1 Comp. 01.2439A 01.2439B	13.8:1 comp. 40229M0770	14:1 Comp. 8957DA 8957DB	13.8:1 Comp. VT24371A VT24371B	14:1 Comp. 362953	Top End C3695	Top End 35-0025 Complete w/ oil seals 37-0029	Cylinder Works 20013 (Std. 77mm) Cylinder Works Complete Kit 20013-K01 (Std. 77mm)	Titanium Exhaust 80-82316T Titanium Intake 80-82312T Valve Spring Kit 80-82300	Valve Guide Intake 80-82320 Exhaust 80-82330 Valve Seals Pkg. of 4 80-82345		CC-2414				830046 49-822994	Bearing / Seal Kit (19-21) 49K021		
WR-250F Cyl. No. 1SM 249cc Liquid Cooled 77mm 3.031"	2015-19	AC	YA-5780	77.00 77.00	Std. Std.	13.5:1 Comp. (15-17) 01.2414A (18-19) 01.2417A	13.5:1 Comp. (15-17) 40116M07700 (18-19) 40151M07700	13.7:1 Comp. (15-17) 8893DA (18-19) 8942DA	13.5:1 Comp. (15-17) VT23941A (18-19) VT24109A		Top End C3549-EST	Top End 35-0690 Complete w/ oil seals 37-1690	Cylinder Works 20010 (Std. 77mm) Cylinder Works Complete Kit (15-17) 20010-K01 (Std. 77mm) (18-19) 20010-K02 (Std. 77mm)	Titanium Exhaust 80-80916T Titanium Intake 80-80912T Valve Spring Kit 80-80900	Valve Guide Intake 80-80920 Exhaust 80-80930 Valve Seals Pkg. of 4 80-80990	Hot Cams Camshaft Stage 1 4270-11N (Intake) 4271-1E (Exhaust)	CC-2414	Pro-X 03.2414 Hot Rods HR8717		830046 49-822175	Bearing / Seal Kit 49K021			
WR-250F Cyl. No. 37B 249cc Liquid Cooled 77mm 3.031"	2020-24	AC	YA5780	77.00 77.01	Std. Std.	13.8:1 Comp. 01.2439A 01.2439B	13.8:1 comp. 40229M0770	14:1 Comp. 8957DA 8957DB	13.8:1 Comp. VT24371A VT24371B		Top End C3695	Top End 35-0025	Cylinder Works 20013 (Std. 77mm) Cylinder Works Complete Kit 20013-K01 (Std. 77mm)	Titanium Exhaust 80-82316T Titanium Intake 80-82312T Valve Spring Kit 80-82300	Valve Guide Intake 80-82320 Exhaust 80-82330 Valve Seals Pkg. of 4 80-82345		CC-2414	Pro-X 03.2414		830046 49-822994	Bearing / Seal Kit (20-21) 49K021			
WR-250 R/X (3D7) 249cc Liquid Cooled 4 Valve 77mm 3.031"	2008-20	AC	YA-5701	77.00 77.01	Std. Std.			11.8:1 Comp. 8729DA 8729DB				Top End 35-0691											49-822377	
XT-350 TT-350 346cc Single 86mm 3.386"	1985-00 1986-87	RS	YA-902	86.00 87.00 87.50	Std. .040 .060		9:1 Comp. 4674M08600 4674M08700 4674M08750				C7530 (XT)												Right 6206C3 (85) 6306C3 (All)	
YZ-400F WR-400F 399cc Liquid Cooled 92mm 3.622"	1998-99 1998-00	AC	YA-5359	5359K 92.00 92.01 94.00	Std. Std. .080	12.5:1 Comp. 7140A 7140B	12.5:1 Comp. 4649M09200	12.5:1 Comp. 8603DA	12.5:1 Comp. VT22567A		Top End C7400 (92mm) C7401 (94mm)	Top End 35-2418 Top End (WR, '00) 35-2420		Steel Exhaust 2X 28-24181 Steel Intake 1X 28-24182 Steel Intake 2X 28-24183 Kibblewhite Valve Spring Kit 80-80100	Valve Guide Intake 80-80110 O/S+.002 80-80112 Exhaust 80-80120 O/S+.002 80-80122	Hot Cams Camshaft 4002-11N (Intake) 4035-1E (Exhaust)	CC-2419	Pro-X 04944		83C072C 49-822167				

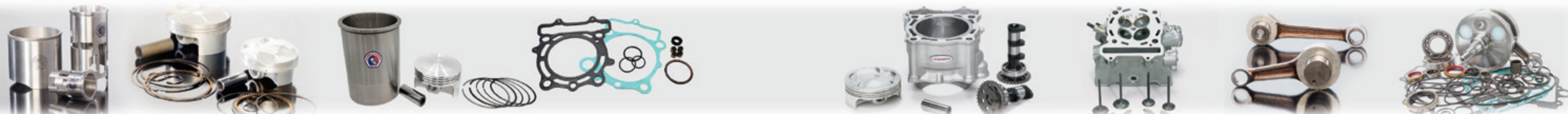

GASGAS
HONDA
HUSQVARNA
KAWASAKI
KTM
SUZUKI
YAMAHA
DIRT BIKE SLEEVES
STREET BIKE SLEEVES
ACCESSORIES
TECHNICAL



MODEL
Engine Description
Cylinder I.D. (mm/in.)



SLEEVE

REBUILD KIT
Sleeve • Piston
Gasket • T.E. Bearing

BORE SIZE (mm)

PISTON SIZE

TOP END

TOP END

VALVE TRAIN

BOTTOM END

PRO-X PISTON

WISECO PISTON

WOSSNER PISTON

VERTEX PISTON

JE PISTON

COMETIC GASKET

L.A. SLEEVE GASKET

CYLINDER AFTERMARKET KITS

VALVE / SPRING KIT

VALVE GUIDE

CAMSHAFT

CAM CHAIN

CRANKSHAFT

CON-ROD KIT

CRANK BEARING

ENGINE OIL SEAL KIT

BOTTOM END KIT
Crankshaft • Bearings • Seals • Gasket Set

YAMAHA FOUR-STROKE (CONTINUED)

MODEL	Engine Description	Cylinder I.D. (mm/in.)	SLEEVE	REBUILD KIT	BORE SIZE (mm)	PISTON SIZE	PRO-X PISTON	WISECO PISTON	WOSSNER PISTON	VERTEX PISTON	JE PISTON	COMETIC GASKET	L.A. SLEEVE GASKET	CYLINDER AFTERMARKET KITS	VALVE / SPRING KIT	VALVE GUIDE	CAMSHAFT	CAM CHAIN	CRANKSHAFT	CON-ROD KIT	CRANK BEARING	ENGINE OIL SEAL KIT	BOTTOM END KIT	
YZ-426F WR-426F	2000-02 2001-02 426cc Liquid Cooled 95mm	95.00 95.01	5424K	95.00 95.01	Std. Std.	12.5:1 Comp. 7150A 7150B	12.5:1 Comp. 4693M09500	12.5:1 Comp. 8525DA 8525DB	12.5:1 Comp. VT22605A		Top End C7689		Top End 35-2420 Complete w/ oil seals 37-2420	Steel Exhaust 2X 28-24181 Steel Intake 1X 28-24182 Steel Intake 2X 28-24183 Kibblewhite Valve Spring Kit 80-80100	Valve Guide Intake 80-80110 O/S+.002 80-80112 Exhaust 80-80120 O/S+.002 80-80122	Hot Cams Camshaft 4002-11N (Intake) 4035-1E (Exhaust)	CC-2419		Pro-X 04946	83C072C	49-822167			
YZ-450F (5TA) WR-450F (5TA)	2003-05 2003-06 449cc Liquid Cooled 95mm	95.00 97.00	5495K	95.00 97.00	Std. .080	12.5:1 Comp. 7180A 7188	12.5:1 Comp. 4785M09500 4785M09700	12.5:1 Comp. 8562DA 8562D200	12.5:1 Comp. VT22915A	12.5:1 Comp. 247944	Top End C7947-EST (95mm)		Top End 35-2423 Complete w/ oil seals 37-2423	Cylinder Works 20001 (Std. 95mm) Cylinder Works Complete Kit 20001-K02 (Std. 95mm)	Titanium Exhaust 2X 28-24231 Titanium Intake 1X 28-24232 Titanium Intake 2X 28-24233 Steel Exhaust 2X 80-80217H Steel Intake 1X 80-80215H Steel Intake 2X 80-80213H Kibblewhite Valve Spring Kit 80-80206	Valve Guide Intake 80-80220 Exhaust 80-80230 Valve Seals Pkg. of 5 80-80710	Hot Cams Camshaft Stage 1 4023-11N (Intake) 4022-1E (Exhaust) (YZ) 4044-1E (Exhaust) (WR)	CC-2423	HR4050 (YZ) HR4162 (WR, '03-06)	Pro-X 04937	83C072C Bearing / Seal Kit 49K022	49-822228	Hot Rods YZ-450F CBK0088	
YZ-450F WR-450F (Cyl. # 2S2)	2006-09 2007-15 449cc Liquid Cooled 95mm	95.00 97.00		95.00 97.00	Std. .080	12.5:1 Comp. 7180A 7188	12.5:1 Comp. 4785M09500 4785M09700	12.5:1 Comp. 8630DA	12.5:1 Comp. VT22915A	12.8:1 Comp. 247625	Top End C7908-EST		Top End 35-0687 Complete w/ oil seals 37-1687	Cylinder Works 20003 (Std. 95mm) Cylinder Works Complete Kit 20003-K01 (Std. 95mm)	Titanium Exhaust 2X 28-24231 Titanium Intake 1X 28-24232 Titanium Intake 2X 28-24233 Steel Exhaust 2X 80-80217H	Valve Guide Intake 80-80220 Exhaust 80-80230 Valve Seals Pkg. of 5 80-80710	Hot Cams Camshaft Stage 1 4023-11N (Intake) 4022-1E (Exhaust) (YZ) 4044-1E (Exhaust) (WR)	CC-2423	(YZ) HR4074	(YZ) Pro-X 04912 Hot Rods HR8643 (WR, 07-11) Pro-X 04912 Hot Rods HR8643 (WR, 12-15) Pro-X 03.2432	83C072C Bearing / Seal Kit 49K022	49-822228	Hot Rods YZ-450F CBK0110	
Big Bore to 478cc	98mm	98.00		98.00	.120		12.5:1 Comp. 8562D300	12.5:1 Comp. VT23404A			Top End C3178-EST (98mm)			Cylinder Works 21003 (478cc, 98mm) Cylinder Works Complete Kit 21003-K01 (478cc, 98mm)	Steel Intake 1X 80-80215H Steel Intake 2X 80-80213H Kibblewhite Valve Spring Kit 80-80206	Complete Head Service Kit 80-82060 Includes Std. Valves, Guides, Spring Kit, Seals, Gaskets								

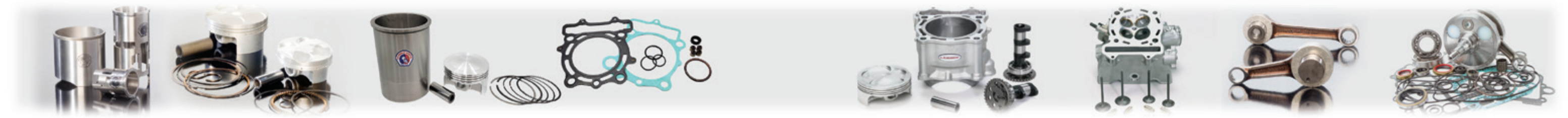

GASGAS
HONDA
HUSQVARNA
KAWASAKI
KTM
SUZUKI
YAMAHA
DIRT BIKE SLEEVES
STREET BIKE SLEEVES
ACCESSORIES
TECHNICAL



MODEL
Engine Description
Cylinder I.D. (mm/in.)



SLEEVE

REBUILD KIT
Sleeve • Piston
Gasket • T.E. Bearing

BORE SIZE
(mm)

PISTON SIZE

TOP END

TOP END

VALVE TRAIN

BOTTOM END

PRO-X PISTON

WISECO PISTON

WOSSNER PISTON

VERTEX PISTON

JE PISTON

COMETIC GASKET

L.A. SLEEVE GASKET

CYLINDER AFTERMARKET KITS

VALVE / SPRING KIT

VALVE GUIDE

CAMSHAFT

CAM CHAIN

CRANKSHAFT

CON-ROD KIT

CRANK BEARING

ENGINE OIL SEAL KIT

BOTTOM END KIT
Crankshaft • Bearings •
Seals • Gasket Set

YAMAHA FOUR-STROKE (CONTINUED)

MODEL	Year	AC	YA-5728	5728K	97.00	Std.	12.5:1 Comp.	12.5:1 Comp.	12.5:1 Comp.	12.5:1 Comp.	12.8:1 Comp.	Top End	Top End	Cylinder Works	Titanium Exhaust	Valve Guide Intake	Hot Cams Camshaft	CC-4409	HR4098	Pro-X	83C072C	49-822228	Hot Rods
YZ-450F 449cc Liquid Cooled 97mm 3.819" (Cyl. # 33D) 4 Valve RESLEEING REQUIRED FOR OVERSIZES CYL. WORKS COMPLETE KIT INCLUDES CYLINDER, PISTON, TOP END GASKETS	2010-13	AC	YA-5728	5728K	97.00	Std.	12.5:1 Comp. 01.2440A 01.2440B	12.5:1 Comp. 40001M09700	12.5:1 Comp. 8776DA 8776DB	12.5:1 Comp. VT23562A VT23562B VT23655A	12.8:1 Comp. 291507	Top End C3395-EST	Top End 35-0689 Complete w/ oil seals 37-1689	Cylinder Works 20005 (Std. 97mm) Cylinder Works Complete Kit 20005-K01 (Std. 97mm) Cylinder Works Complete Kit 21005-K01 (468cc, 99mm)	Titanium Exhaust 28-24401 Titanium Intake 28-24402 Kibblewhite Steel Exhaust 80-80766 Steel Intake 80-80762 Valve Spring Kit 80-80750	Valve Guide Intake 80-80770 O/S+.001 80-80771 Exhaust 80-80710 O/S+.001 80-80781 Valve Seals Pkg. of 4 71040-4	Hot Cams Camshaft Stage 1 4163-11N (Intake) 4164-1E (Exhaust) Stage 2 4165-21N (Intake) 4166-2E (Exhaust)	CC-4409	HR4098	Pro-X 04908 Hot Rods HR8694	83C072C Bearing / Seal Kit 49K022	49-822228	Hot Rods CBK0129
YZ-450F 449cc Liquid Cooled 97mm 3.819" (Cyl. # 1SL) 4 Valve RESLEEING REQUIRED FOR OVERSIZES CYL. WORKS COMPLETE KIT INCLUDES CYLINDER, PISTON, TOP END GASKETS	2014-17	AC	YA-5728	5728K	97.00	Std.	12.5:1 Comp. 01.2444A 01.2444B	12.5:1 Comp. 40111M09700	12.5:1 Comp. 8895DA 8895DB	12.5:1 Comp. VT23958A VT23958B VT23655A	12.8:1 Comp. 324910	Top End C3540-EST	Top End 35-0994 (97mm) 21005-G02 (99mm) Complete w/ oil seals 37-1994	Cylinder Works 20005 (Std. 97mm) Cylinder Works Complete Kit 20005-K02 (Std. 97mm) Cylinder Works Complete Kit 21005-K02 (468cc, 99mm)	Titanium Exhaust 28-24441 Titanium Intake 28-24442 Kibblewhite Steel Exhaust 80-80876 Steel Intake 80-80872 Valve Spring Kit 80-80750	Valve Guide Intake 80-80770 O/S+.001 80-80771 Exhaust 80-80780 O/S+.001 80-80781 Valve Seals Pkg. of 4 71040-4	Hot Cams Camshaft Stage 1 (14-15) 4278-11N (Intake) 4279-1E (Exhaust) Complete Head Service Kit 80-82070 Includes Std. Valves, Guides, Spring Kit, Seals, Gaskets	CC-4409	HR4098	Pro-X 04908 Hot Rods HR8694	83C072C Bearing / Seal Kit 49K022	49-822692	Hot Rods CBK0223
YZ-450F 449cc Liquid Cooled 97mm 3.819" (Cyl. # BR9) 4 Valve RESLEEING REQUIRED FOR OVERSIZES CYL. WORKS COMPLETE KIT INCLUDES CYLINDER, PISTON, TOP END GASKETS	2018-19	AC	YA-5728	5728K	97.00	Std.	12.8:1 Comp. 01.2448A 01.2448B	12.8:1 Comp. 40199M09700	12.9:1 Comp. 8949DA 8949DB	12.8:1 Comp. VT24270A VT24270B VT24369B	13.5:1 Comp. 366510	Top End C3630	Top End 35-0997 (97mm) Complete w/ oil seals 37-1997	Cylinder Works 20012 (Std. 97mm) Cylinder Works Complete Kit 20012-K01 (Std. 97mm) Cylinder Works Complete Kit 21012-K01 (468cc, 99mm)	Titanium Exhaust 28-24441 Titanium Intake 28-24442 Kibblewhite Steel Exhaust 80-80876 Steel Intake 80-80872 Valve Spring Kit 80-80750	Valve Guide Intake 80-80770 O/S+.001 80-80771 Exhaust 80-80780 O/S+.001 80-80781 Valve Seals Pkg. of 4 71040-4	Hot Cams Camshaft Stage 1 HC00059 (Intake) HC00060 (Exhaust)	CC-4409		Pro-X 04908 Hot Rods HR8694	83C072C Bearing / Seal Kit 49K022	49-822692	
YZ-450F 449cc Liquid Cooled 97mm 3.819" (Cyl. # B2W) 4 Valve RESLEEING REQUIRED FOR OVERSIZES CYL. WORKS COMPLETE KIT INCLUDES CYLINDER, PISTON, TOP END GASKETS	2020-22	AC	YA-5728	5728K	97.00	Std.	13:1 Comp. 01.2450A 01.2450B	13:1 Comp. 40254M09700	13.2:1 Comp. 8964DA 8964DB	12.8:1 Comp. VT24448A VT24448B VT24461A	13.8:1 Comp. 366828	Top End C3786	Top End 35-0031 (97mm) 35-0039 (99mm)	Cylinder Works 20014 (Std. 97mm) Cylinder Works Complete Kit 20014-K01 (Std. 97mm) Cylinder Works Complete Kit 21014-K01 (468cc, 99mm)	Titanium Exhaust 28-24501 Titanium Intake 28-24502			CC-2423		Pro-X 03.2450	83C072C Bearing / Seal Kit 49K022	49-822692	

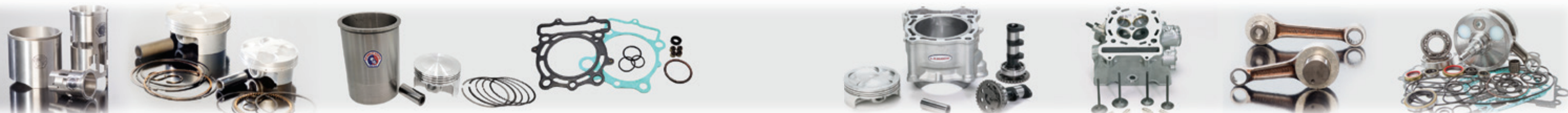

GASGAS
HONDA
HUSQVARNA
KAWASAKI
KTM
SUZUKI
YAMAHA
DIRT BIKE SLEEVES
STREET BIKE SLEEVES
ACCESSORIES
TECHNICAL



MODEL
Engine Description
Cylinder I.D. (mm/in.)



SLEEVE

REBUILD KIT
Sleeve • Piston
Gasket • T.E. Bearing

BORE SIZE (mm)

PISTON SIZE

TOP END

TOP END

VALVE TRAIN

BOTTOM END

PRO-X PISTON

WISECO PISTON

WOSSNER PISTON

VERTEX PISTON

JE PISTON

COMETIC GASKET

L.A. SLEEVE GASKET

CYLINDER AFTERMARKET KITS

VALVE / SPRING KIT

VALVE GUIDE

CAMSHAFT

CAM CHAIN

CRANKSHAFT

CON-ROD KIT

CRANK BEARING

ENGINE OIL SEAL KIT

BOTTOM END KIT
Crankshaft • Bearings • Seals • Gasket Set

YAMAHA FOUR-STROKE (CONTINUED)

Table with columns for Model, Engine Description, Cylinders, Bore Size, Piston Size, Compression Ratio, Piston Brand, Gasket, and various engine components (Sleeve, Rebuild Kit, Valve Train, Bottom End Kit).

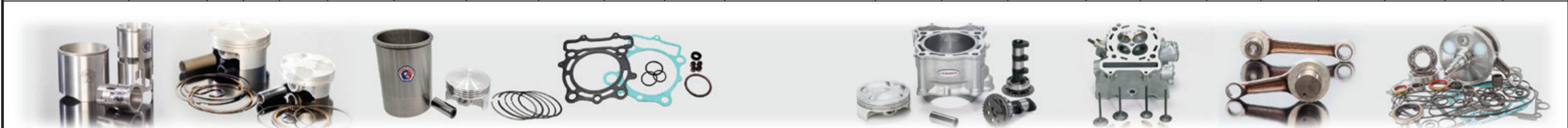

GASGAS HONDA HUSQVARNA KAWASAKI KTM SUZUKI YAMAHA DIRT BIKE SLEEVES STREET BIKE SLEEVES ACCESSORIES TECHNICAL



DIRT BIKE SLEEVES

Current, Non Current, Vintage and Classic Models.

MODEL	Year	Size (mm)	Type	Part #
ATK 2-STROKE				
ATK 250 (ROTAX)	1992-95	72	RS/MO	FL-5192
ATK 250, 260 (ROTAX)	1995-04	67.5	AC/MO	FL-5262
ATK 406 (ROTAX)	1990-95	84	RS	FL-5155

MODEL	Year	Size (mm)	Type	Part #
ATK 4-STROKE				
ATK 490, 500 (ROTAX)	1999-03	89	RS	FL-5384
ATK 604 (ROTAX 600)	1991-93	97	RS/L	FL-5161
ATK 605 (ROTAX)	1994-03	97	RS	FL-5248

MODEL	Year	Size (mm)	Type	Part #
AJS 2-STROKE				
250 Y4		68	RS/L	FL-228
370 Y50, 400 Y51		83	RS/MO	FL-229B

MODEL	Year	Size (mm)	Type	Part #
AJS 4-STROKE				
500	1950	83.5	CS/MO	FL-5738

MODEL	Year	Size (mm)	Type	Part #
BSA 4-STROKE				
GOLD STAR 500 (5-5/8" Long)		85	RS/MO	FL-182
GOLD STAR 500 (6" Long)		85	RS/MO	FL-248
B-44 Round Barrel		79	CS/MO	FL-5850
VICTOR 440 Round Barrel	1966-67	79	CS/MO	FL-186
VICTOR 440 Square Barrel	1968-70	79	RS/MO	FL-173
VICTOR 500 MX	1972	84	RS/MO	FL-234

MODEL	Year	Size (mm)	Type	Part #
BULTACO 2-STROKE				
125 Pursang	1977	54	RS/L	FL-647
125 Sherpa S		51.5	RS/L	FL-231
200 Pursang 134 Series	1975		N/A	FL-653
200 Sherpa		64	RS/MO	FL-243
250 Astro	1972	72	RS/MO	FL-240
250 Astro	1977	70	RS/L	FL-389
250 Astro	1978-79	70	RS/MO	FL-675
250 Matador 107 Series		72	RS/MO	FL-232
250 MK IX 167 Series	1976	72	RS/L	FL-381
250 Pursang	1970	72	RS/MO	FL-253
250 Pursang	1971	72	RS/MO	FL-191
250 Pursang	1973-76	72	RS/MO	FL-320
250 Pursang 192 Series	1977	72	RS/L	FL-390
250 Pursang	1979	70	RS/L	FL-713
350 Alpina	1976	83.2	RS/MO	FL-391
350 Pursang, Alpina		83.2	RS/L	FL-241B
350 Sherpa T	1972-74	83.2	RS/MO	FL-651
360 Bandit	1970	85	RS/L	FL-242
360 Pursang MK VII 121 Series	1974	83.2	RS/L	FL-321
360 Pursang MK VIII 136 Series	1975-76	84	RS/MO	FL-322
360 Pursang 168 Series	1976	84	RS/MO	FL-392
370 Frontera 181 Series	1977	84	RS/MO	FL-392
370 Pursang 193 Series	1977	85	RS/L	FL-394

MODEL	Year	Size (mm)	Type	Part #
CAGIVA				
WMX 125	1985-86	56	AC/MO	FL-934
WMX 125	1987-88	56	AC/L	FL-5074
WMX 125	1989-90	56	AC/L	FL-5172
WMX 125	1991-92	56	AC/L	FL-5186
WMX 200	1984	67	AC/L	FL-913
WMX 250	1988-90	70	AC/L	FL-5058

MODEL	Year	Size (mm)	Type	Part #
CAN-AM 2-STROKE				
MX-125	1984-85	54	AC/MO	FL-907
125 Flanged Replacement Sleeve	Pre-80's	54	RS/L	FL-190
MX-175 2,3	1975-77	62	RS/L	FL-908
175 ASE	1984	62	RS/L	FL-908
MX-250 2,3	1974-77	74	RS/MO	FL-909
MX-250 4,5 (O.D. 3.256")	1978-83	72	RS/L	FL-910
MX-250 (O.D. 3.117")	1978-83	72	RS/MO	FL-5192
MX-250 (Liquid-Cooled)	1985-86	72	AC/L	FL-966
350 ASE	1980-81	76	RS/MO	FL-5575
500 (486cc) Rotax		85	RS/L	FL-5482
Rotax 600	1987-93	97	4-Cycle, RS	FL-5161

MODEL	Year	Size (mm)	Type	Part #
CAN-AM 4-STROKE				
Sabre 500 MX	1982-83	89	RS	FL-727
Sonic 560 MX	1985	94	RS/MO	FL-911

MODEL	Year	Size (mm)	Type	Part #
CZ 2-STROKE				
250 MX	1958	70	RS/MO	FL-5587
250 MX	1969-75	70	RS/MO	FL-133
ISDT 250	1981-82	70	RS/L	FL-823
400 MX (O.D. 3.705")	1968	82	RS/L	FL-324
400 MX (O.D. 3.785")	1972	82	RS/MO	FL-249

MODEL	Year	Size (mm)	Type	Part #
FANTIC 2-STROKE				
Caballero 125	1997	55	AC	FL-5355
Fantic 250 Series 301, 303	1986-88	74	AC/L	FL-996
Fantic 250 Series 307, 309	1989-93	74	AC/L	FL-5149

MODEL	Year	Size (mm)	Type	Part #
GAS GAS 2-STROKE				
MC 50	2021-23	39.5	AC	FL-5746
MC 65	2021-23	45	AC	FL-5747
MC 85	2021-23	47	AC	FL-5796
MC 125	2021-23	54	AC	FL-5804
125 Liquid-Cooled (EURO)	2008-10	54	AC/MO	FL-7045
EC 250	1998-00	66.4	AC	FL-5483
EC 250 TPI	2022-23	66.4	AC	FL-5811
EC 250 TPI	2024	66.4	AC	FL-5859
EX 250	2022-23	66.4	AC	FL-5811
EX 250	2024	66.4	AC	FL-5859
MC 250	2022-23	66.4	AC	FL-5811
MC 250	2024	66.4	AC	FL-5859
EC 300 TPI	2022-23	72	AC	FL-5815
EC 300 TPI	2024	72	AC	FL-5860
EX 300	2022-23	72	AC	FL-5815
EX 300	2024	72	AC	FL-5860

MODEL	Year	Size (mm)	Type	Part #
GAS GAS 4-STROKE				
EC-250F	2021-23	78	AC	FL-5743
EX-250F	2021-23	78	AC	FL-5743
MC-250F	2021-23	78	AC	FL-5743
EC-350F	2021-23	88	AC	FL-5745
EX-350F	2021-23	88	AC	FL-5745
MC-350F	2021-23	88	AC	FL-5745
EX-450F	2021-23	95	AC	FL-5744
MC-450F	2021-23	95	AC	FL-5744

MODEL	Year	Size (mm)	Type	Part #
HARLEY-DAVIDSON 2-STROKE				
SX 175		61	AC/MO	FL-338
SX 250	1975	72	AC/L	FL-341
MX 250	1977	72	AC/L	FL-398

MODEL	Year	Size (mm)	Type	Part #
HONDA 2-STROKE				
MR50 Elsinore	1974	40	CI/MO	H-624
CR60	1983	42.5	L	H-5524H
CR60	1984	42.5	MO	H-758H
CR-80R	1984	49.5	CS	H893C
CR-80R	1985	47	CS	H894
CR-80R	1986	47	AC	H-948
CR-80R	1987-02	47	AC	H-5066
CR-80R Big Bore 102-105cc	1986-02	52	AC	H-948B
CRE-80	1995-99	46	AC	H-7024
CR-85R	2003-04	47.5	AC	H-5488
CR-85R Big Bore 96-102cc	2003-04	50.5	AC	H-5488B
CR-85R	2005-07	47.5	AC	H-5599
CR-85R Big Bore 96-102cc	2005-07	50.5	AC	H-5599B
CR-125 Elsinore	1973-74	56	CI/L	H-85
CR-125 Elsinore	1975-78	56	CI/L	H-085
CR-125R	1979	56	AC/L	H-1
CR-125R	1980	55.5	CS	H-94
CR-125R	1981-82	55.5	CS	H-99
CR-125R Sleeve Down 100cc	1981-82	50	CI	H-99SD

DIRT BIKE SLEEVES

Current, Non Current, Vintage and Classic Models.



MODEL	Year	Size (mm)	Type	Part #
HONDA 2-STROKE (Continued)				
CR-125R	1983-84	55.5	CS	H-114
CR-125R	1985-86	54	CS	H-940
CR-125R	1987-88	54	CS	H-5001
CR-125R	1989	54	AC	H-5075
CR-125R	1990-91	54	AC	H-5104
CR-125R	1992	54	AC	H-5301
CR-125R	1993-95	54	AC	H-5249
CR-125R	1996-99	54	AC	H-5291
CR-125R (Cyl. No. 99)	2000	54	AC	H-5439
CR-125R (Cyl. No. 00)	2001	54	AC	H-5450
CR-125R (Cyl. No. 01)	2002	54	AC	H-5466
CR-125R (Cyl. No. 02)	2003	54	AC	H-5489
CR-125R (Cyl. No. KSRRA)	2004	54	AC	H-5568
CR-125R (Cyl. No. KSRF)	2005-07	54	AC	H-5579
CRE-125, CRM-125 (Euro)	1992-96	54	AC	H-7004
MTX-125 (Euro)	1988-91	56	AC	H-7002
MTX-125 (Euro)	1992-96	54	AC	H-7004
NS-125 (Euro)	1988-90	56	AC	H-7002
NSR-125 (Euro)	1991-95	54	AC	H-7004
MR-175	1975	66	NA	H-83
CR-250 Elsinore	1973-74	70	CI/L	H-29
CR-250 Elsinore	1975-77	70	CI/MO	H-929
CR-250R	1978-80	70	AC	H-88
CR-250R ATAC	1981-83	66	CI	H-104
Large O.D. to repair broken skirt		66	CS/MO	H-104H
CR-250R ATAC	1984	66	CI	H-843
Large O.D. to repair broken skirt		66	CS/MO	H-843H
CR-250R ATAC	1985	66	CI	H-844
Large O.D. to repair broken skirt		66	CS/MO	H-844H
CR-250R	1986	66.4	AC	H-958
CR-250R	1987	66.4	AC	H-5002
CR-250R	1988-89	66.4	AC	H-5076
CR-250R	1990-91	66.4	AC	H-5105
CR-250R (KZ3)	1992-93	66.4	AC	H-5178
CR-250R (KZ3L)	1994	66.4	AC	H-5198
CR-250R (KZ3M)	1995-96	66.4	AC	H-5250
CR-250R (KZ3P)	1997-98	66.4	AC	H-5318
CR-250R (KZ3S, KZ3T)	1999-00	66.4	AC	H-5375
CR-250R (KZ3V)	2001	66.4	AC	H-5448
CR-250R (KZ3W, KZ3X)	2003-03	66.4	AC	H-5477
CR-250R (KSK)	2004	66.4	AC	H-5535
CR-250R (KSK)	2005-07	66.4	AC	H-5580
CR-450R	1981	85	CS/L	H-109
CR-480R	1982-83	89	CS/L	H-110
CR-500R	1984	89	CI/L	H-846
CR-500R	1985-86	89	CS/L	H-847
CR-500R	1987-88	89	CS/L	H-5003
CR-500R	1989-01	89	CI	H-5077
Large O.D. to repair broken skirt		89	CS	H-5077C

HONDA 4-STROKE				
CRF-50F	2004-24	39	CC	H-5438
XR-50R	2000-03	39	CC	H-5438
CRF-70F	2004-12	47	CC	H-5387
XR-70R	1997-03	47	CC	H-5387
CT-70	1977-82	47	CC/MO	H-8
CRF-80F	2004-13	47.5	CS	H-101
XL-80, XR-80R	1979-03	47.5	CS	H-101
C90, CM90, S90		50	CC/MO	H-9
CRF-100F	2004-13	53	CI	H-5197
XR-100R	1992-03	53	CI	H-5197
CRF/XR-100 Big Bore to 120cc	1992-13	58	CI	H-5197B
XL-125	1976-85	56.5	RS/MO	H-2
CRF-150F	2003-05	63.5	CI	H-5490
CRF-150F	2006-17	57.3	CI	H-5606
CRF-150R	2007-24	66	AC	H-5635
CRF-150R Big Bore to 170cc	2007-24	70	AC	H-5733
XR-150L	2023-24	57.3		H-5606

MODEL	Year	Size (mm)	Type	Part #
HONDA 4-STROKE (Continued)				
XL-175	1973-78	64	RS/MO	H-84
XL, XR-185	1979-84	63	CS	H-3
XL-200R	1983-84	65.5	CI	H-103
XR-200	1980-84	65.5	CI	H-103
XR-200R	1980-83	65.5	CI	H-103
XR-200R	1984-85	67	CS	H-841
XR-200R	1986-02	65.5	CI	H-103
Fat Cat 200	1986-87	65	CS	H-989
CRF-230F	2003-19	65.5	CI	H-5491
CRF-250R/X	2004	78	AC	H-5531
CRF-250R	2005-09	78	AC	H-5597
CRF-250X	2005-17	78	AC	H-5597
CRF-250R	2010-17	76.8	AC	H-5739
CRF-250R/RX	2018-24	79	AC	H-5803
CRF250R Big Bore to 270cc Ductile	2005-09	80-81	AC	H-5597D
Big Bore 280cc Wet Liner Ductile	2005-09	82	AC	H-5731
CRF250R Big Bore to 270cc Ductile	2010-17	79-80	AC	H-5739B
XL-250 (O.D. 3.350")	Thru '77	74	RS/MO	H-22
XL, XR-250 (O.D. 3.192")	1978-83	74	RS/MO	H-98
XL, XR-250R	1984-85	75	RS	H-842
XL-250R RFVC	1986-87	75	RS	H-5312
XR-250R RFVC	1986-04	73	RS	H-957
XR-250L	1991-96	73	RS	H-957
XR250R,L Big Bore to 285cc	1986-04	75.5 - 78		H-957B
XL-350	1973-79	79	RS/L	H-27
XL-350 (O.D. 3.510")	1983-84	84	RS/L	H-119
XR-350 (O.D. 3.549")	1983-84	84	RS/L	H-943
XR-400R	1986-04	85	RS	H-5293
XR-400R Big Bore to 440cc	1996-04	88-89	RS	H-5445
CRF-450R	2002-03	96	AC	H-5475
CRF-450R Big Bore 477cc to 488cc	2002-03	98-100	AC	H5475B
Big Bore 497cc Wet Liner Ductile	2002-03	101	AC/MO	H-5475BB
CRF-450R	2004-08	96	AC	H-5537
CRF-450R Big Bore to 477cc	2004-08	98-99	AC	H-5537B
Big Bore to 477cc Wet liner Ductile	2004-08	98-99	AC/MO	H-5537BB
CRF-450R	2009-16	96	AC	H-5695
CRF-450R / RX	2017-24	96	AC	H-5801
CRF-450X	2005-17	96	AC	H-5537
CRF-450X	2019-24	96	AC	H-5801
CRF-450L	2019-20	96	AC	H-5801
CRF-450RL	2021-24	96	AC	H-5801
XL, XR-500	1979-82	89	RS	H-5
XL, XR-500 Big Bore to 570cc	1979-82	95	MO	H-5B
XR-500	1983-84	92	RS	H-839
XL-600	1983-87	100	RS	H-120
XR-600R	1985-87	97	RS	H-960
XR-600R	1988-90	97	AC	H-5037
XR-600R Big Bore to 628cc	1988-90	100	AC	H-5037B
XR-600R	1991-00	97	RS	H-5159
XR-628 Honda Factory Kit	1988-95	100	RS	H-5160
XR-650L	1993-23	100	RS	H-5160
XR-650L Big Bore 720cc (Case Mod)	1993-23	105	MO	H-5160B
XR-650R (Liquid Cooled)	2000-07	100	AC	H-5440
NX-650 Dominator	1988-03	100	RS	H-5160

HUSABERG 4-STROKE				
FX 450	2010-	95	AC	FL-5820
FC, FE, FX 501	1995-02	95	CI	FL-5484
FC, FE, FS, FX 600	1993-00	95	AC	FL-5202

HUSQVARNA 2-STROKE				
TC-50	2017-23	39.5	AC	FL-5746
TC-65	2017-23	45	AC	FL-5747
TC-85	2014-17	47	AC	FL-5551
TC-85 Big Bore to 105cc	2014-17	52	AC	FL-5551B
TC-85	2018-24	47	AC	FL-5796
CR-125 (Reed)	1975-77	55	CS/L	FL-657
CR-125	1978-79	55	RS/L	FL-674



DIRT BIKE SLEEVES

Current, Non Current, Vintage and Classic Models.

MODEL	Year	Size (mm)	Type	Part #
HUSQVARNA 2-STROKE (Continued)				
CR-125	1980-81	55	MO	FL-730
CR-125	1982	55	RS/MO	FL-731
CR-125	1983	55	RS/L	FL-915
CR, XC-125 Liquid Cooled	1984-87	55	RS/L	FL-993
WRK-125	1988-89	56	AC/L	FL-5074
WXC, WXE-125	1991-92	56	AC/L	FL-5186
WXC, WXE-125	1994-95	56	AC/L	FL-5203
WXC, WXE-125	1996-97	56	AC/L	FL-5320
CR, WR-125	1999-00	54	AC	FL-5452
CR, WR-125	2001-02	54	AC	FL-5453
CR, WR-125	2003-08	54	AC	FL-5544
TC-125	2014-15	54	AC	FL-5692
TC-125	2016-22	54	AC	FL-5804
TE-125	2015-16	54	AC	FL-5692
TE-150, TE-150i	2017-23	58	AC	FL-5805
175	1973-74	64	CS/L	FL-399
WR-175	1983-84	64.5	RS/L	FL-994
WR-250	1972	69.5	CS/MO	FL-246
WR-250	1973	69.5	CS/MO	FL-388
CR-250	1974-77	69.5	CS/MO	FL-326
CR-250	1978-79	69.5	RS/L	FL-660
CR, WR-250	1980-81	69.5	RS/L	FL-732
CR, WR, XC-250	1982	69.5	RS/MO	FL-733
CR, WR-250	1983	69.5	RS/L	FL-828
CR-250	1984	69.5	RS/L	FL-916
CR-250	1985	69.5	RS/L	FL-955
CR-250	1986	69.5	RS/L	FL-962
CR-250 MX	1987-88	66.5	RS/L	FL-5103
WR, XC-250	1987-88	66.5	RS/L	FL-997
WXC, WMX-250	1988-90	70	AC/L	FL-5058
WXC, WMX-250	1991	70	AC	FL-5164
WR, WXC, WXC, WMX-250	1992	70	AC	FL-5165
WXC, WXC-250	1993	67	AC	FL-5204
WXC, WXC-250	1994	67	AC	FL-5205
CR, WR-250	1999	66.4	AC	FL-5390
CR, WR-250	2000	66.4	AC	FL-5444
CR, WR-250	2001-02	66.4	AC	FL-5454
CR-250	2003-05	66.4	AC	FL-5545
WR-250	2003-13	66.4	AC	FL-5545
TC, TE-250	2014-16	66.4	AC	FL-5748
TC, TE-250	2017-18	66.4	AC	FL-5785
TC-250	2019-23	66.4	AC	FL-5811
TE-250i	2018-19	66.4	AC	FL-5785
TE-250i	2020-23	66.4	AC	FL-5811
WR-300	2009-13	72	AC	FL-5774
TE-300	2014-16	72	AC	FL-5749
TE-300	2017-18	72	AC	FL-5798
TE-300i	2020-23	72	AC	FL-5815
TE-300i	2024	72	AC	FL-5860
TX-300	2017-18	72	AC	FL-5798
TX-300	2019	72	AC	FL-5815
TX-300i	2020-22	72	AC	FL-5815
TX-300i	2023-24	72	AC	FL-5860
WXC, WXC-350	1993-94	84	RS	FL-5207
WXC, WXC-350	1995	84	AC	FL-5423
360 GP	1975-77	82	CS/MO	FL-360
WXC-360	1992	78	AC	FL-5158
WXC, WXC-360	1993-94	78	AC	FL-5206
WR-360	1998-02	78	AC/MO	FL-5391
CR-390	1977-80	83	CS/MO	FL-390
400		81.5	RS/MO	FL-236
WR-400 Liquid-Cooled	1984-85	82.5	RS/L	FL-917
CR-430	1981-82	86	RS/L	FL-734
CR-430 MX, AE Liquid-Cooled	1987-88	86	RS/L	FL-998
WR-430	1987-88	86	RS/L	FL-998
450	1973	84	NA	FL-335
CR, XC-500	1983-84	86	RS/L	FL-824
CR, XC-500	1985-87	86	RS/L	FL-963

MODEL	Year	Size (mm)	Type	Part #
HUSQVARNA 4-STROKE				
TC, TE-250	2002-09	76	AC	FL-5546
TC, TE, TXC 250	2010-13	79	AC	FL-5862
FC, FE-250	2014-23	78	AC	FL-5743
FC, FE, FX 350	2014-23	88	AC	FL-5745
WXC, WXC-410	1991-94	91.5	RS/AC	FL-5376
WXC, WXC-410	1995-97	91.5	AC	FL-5325
TC, TE-410	1998-01	91.5	AC	FL-5325
TC, TE-450	2002-10	97	AC	FL-5547
TC, TE, TXC-449	2011-14	97	AC	
FC, FE, FS, FX 450	2014-24	95	AC	FL-5744
AE, TC-500	1985-86	90	RS/MO	FL-950
FE-501	2014-23	95	AC	FL-5772
TE-510	1985-86	91.5	RS/MO	FL-936
TC, TE, TX-510	1987-88	91.5	AC	FL-5059
TC, TE, TXC-510	2004-10	97	AC	FL-5548
TC, TE-610	1998-10	98	AC	FL-5314
WMX, WXC-610	1991-95	98	RS/L	FL-5078
WMX, WXC-610	1996-97	98	AC	FL-5314
701 ENDURO	2016-20	105	AC	FL-5808

ITALJET / INDIAN 2-STROKE				
Mini SE-74 Minarelli 70	Pre-74	45	RS/L	FL-226
Compact 80	1975	47	RS/L	FL-355

KAWASAKI 2-STROKE				
KDX-50	2003-06	41	CC	FL-5492
KX-60	1985-03	43	AC	KA-935
KX-65 (Cyl. No. 1931)	2000-01	44.5	AC	KA-5431
KX-65 (Cyl. No. 1973)	2002-24	44.5	AC	KA5472
KX-80	78-79	48	AC	KA-672
KX-80	1980-81	48	AC	KA-735
KX-80	1982	48	AC	KA-736
KX-80 Liquid-Cooled	1983	48	AC	KA-791
KX-80	1984	48	AC	KA-852
KX-80	1985	48	AC	KA-854
KX-80	1986-87	48	AC	KA-967
KX-80	1988-90	48	AC	KA-5041
KX-80	1991-94	48	AC	KA-5121
KX-80	1995-97	48	AC	KA-5316
KX-80	1999-00	48	AC	KA-5351
KX-80 Big Bore to 100cc	1982	52	AC/L	KA-798
KX-80 Big Bore to 100cc	1983	52	AC/L	KA-799
KX-80 Big Bore to 100cc	1984	52	AC/L	KA-853
KX-80 Big Bore to 100cc	1985	52	AC/MO	KA-858
KX-80 Big Bore to 100cc	1986-87	52	AC	KA-968
KX-80 Big Bore to 100cc	1988-90	52	AC	KA-5042
KX-80 Big Bore to 100cc	1991-97	52	AC	KA-5263
KX-80 Big Bore to 100cc	1998-00	52.5	AC	KA-5351B
KDX-80	1980-82	48	AC	KA-672
KDX-80	1983-88	48	AC	KA-736
KX-85	2001-13	48.5	AC	KA-5449
KX-85	2014-24	48.5	AC	KA-5778
KX-85 Big Bore to 100cc	2001-13	52.5	AC	KA-5351B
KX-85 Big Bore to 100cc	2014-24	52.5	AC	KA-5779
KE-100	1976-01	49.5	AC/MO	KA-786
KM-100	1976-81	49.5	AC/MO	KA-5525
KX-100	1995-97	52.5	AC	KA-5263
KX-100	1998-05	52.5	AC	KA-5358
KX-100	2006-13	52.5	AC	KA-5608
KX-100	2014-21	52.5	AC	KA-5779
KX-112	2022-24	52.5	AC	KA-5779
KE-125	1980-83	56	AC/L	KA-784
KX-125	1974-77	56	AC/MO	KA-331
KX-125	1978-79	56	AC/L	KA-656
KX-125	1980	56	AC/L	KA-680
KX-125	1981	56	AC/L	KA-717
KX-125 Liquid-Cooled	1982	56	AC/L	KA-737
KX-125	1983-84	56	AC/L	KA-792

DIRT BIKE SLEEVES

Current, Non Current, Vintage and Classic Models.



MODEL	Year	Size (mm)	Type	Part #
KAWASAKI 2-STROKE (Continued)				
KX-125 KIPS	1985	56	AC/L	KA-855
KX-125 KIPS (Cyl. No. 1476)	1986	56	AC	KA-945
KX-125 KIPS (Cyl. No. 1508)	1987	56	AC	KA-5006
KX-125 (Cyl. No. 1539)	1988	56	AC	KA-5043
KX-125 (Cyl. No. 1565)	1989	56	AC	KA-5089
KX-125 (Cyl. No. 1602)	1990	56	AC	KA-5107
KX-125 (Cyl. No. 1645)	1991	56	AC	KA-5107
KX-125 (Cyl. No. 1672)	1992	54	AC	KA-5154
KX-125 (Cyl. No. 1687)	1993	54	AC	KA-5179
KX-125 (Cyl. No. 1720)	1994	54	AC	KA-5208
KX-125 (Cyl. No. 1752)	1995	54	AC	KA-5251
KX-125 (Cyl. No. 1794)	1996	54	AC	KA-5307
KX-125 (Cyl. No. 1840)	1997	54	AC	KA-5307
KX-125 (Cyl. No. 1852)	1998	54	AC	KA-5354
KX-125 (Cyl. No. 1881)	1999	54	AC	KA-5354
KX-125 (Cyl. No. 1921)	2000	54	AC	KA-5429
KX-125 (Cyl. No. 1939)	2001	54	AC	KA-5451
KX-125 (Cyl. No. 1960)	2002	54	AC	KA-5473
KX-125 (Cyl. No. 1978)	2003	54	AC	KA-5485
KX-125 (Cyl. No. 0013)	2004	54	AC	KA-5570
KX-125 (Cyl. No. 0026)	2005	54	AC	KA-5570
KDX-125 (Euro)	1990-95	56	AC/MO	KA-7013
KMX-125 (Euro)	1986-90	54	AC/MO	KA-7006
KMX-125 (Euro)	1991-95	54	AC/MO	KA-7043
KDX-175	1980-81	66	AC/MO	KA-681
KDX-175	1982	66	AC/L	KA-738
KE-175	1978	61.5	CS/MO	KA-5373
KE-175	1980-82	62.5	AC/L	KA-785
KDX-200	1983-85	66	AC/L	KA-793
KDX-200 KIPS	1986-88	66	AC/L	KA-969
KDX-200 Liquid-Cooled	1989-94	66	AC	KA-5086
KDX-200 Liquid-Cooled	1995-06	66	AC	KA-5252
KDX-200 Big Bore to 240cc	1983-85	72	AC/L	KA-793BB
KDX-200 KIPS Big Bore to 240cc	1986-88	72	AC/L	KA-969B
KDX-200 Big Bore to 240cc	1989-94	72	AC/L	KA-5086B
KDX-200 Big Bore to 240cc	1995-06	72	AC/L	KA-5252B
KDX-220	1997-05	69	AC	KA-5319
KX-250	1974-77	70	AC/L	KA-361
KX-250	1978	70	AC/L	KA-655
KX-250	1979-81	70	AC/L	KA-662
KX-250	1982	70	AC/L	KA-739
KX-250	1983-84	70	AC/L	KA-796
KX-250 KIPS Liquid-Cooled	1985	70	AC/L	KA-859
KX-250 KIPS Liquid-Cooled	1986	70	AC/L	KA-949
KX-250	1987	67.4	AC	KA-5007
KX-250	1988	67.4	AC	KA-5044
KX-250	1989	67.4	AC	KA-5090
KX-250	1990	67.4	AC	KA-5122
KX-250 (Cyl. No. 1643)	1991	67.4	AC	KA-5123
KX-250 (Cyl. No. 1671)	1992	66.4	AC	KA-5153
KX-250 (Cyl. No. 1686)	1993	66.4	AC	KA-5180
KX-250 (Cyl. No. 1722)	1994	66.4	AC	KA-5209
KX-250 (Cyl. No. 1751)	1995	66.4	AC	KA-5253
KX-250 (Cyl. No. 1793)	1996	66.4	AC	KA-5294
KX-250 (Cyl. No. 1835)	1997	66.4	AC	KA-5321
KX-250 (Cyl. No. 1851)	1998-99	66.4	AC	KA-5350
KX-250 (Cyl. No. 1911)	2000	66.4	AC	KA-5422
KX-250 (Cyl. No. 1938)	2001	66.4	AC	KA-5481
KX-250 (Cyl. No. 1959)	2002	66.4	AC	KA-5471
KX-250 (Cyl. No. 1979)	2003	66.4	AC	KA-5471
KX-250 (Cyl. No. 0014)	2004	66.4	AC	KA-5538
KX-250 (Cyl. No. 0027)	2005-07	66.4	AC	KA-5582
KX-250 Big Bore to 295cc	1987	73	AC/MO	KA-5007B
KX-250 Big Bore to 295cc	1988	73	AC/MO	KA-5044B
KX-250 Big Bore to 295cc	1989	73	AC/MO	KA-5090B
KX-250 Big Bore to 295cc	1990	73	AC/MO	KA-5122B
KX-250 Big Bore to 295cc	1991	73	AC/MO	KA-5123B
KX-250 Big Bore to 295cc	1992	73	AC/MO	KA-5153B

MODEL	Year	Size (mm)	Type	Part #
KAWASAKI 2-STROKE (Continued)				
KX-250 Big Bore to 295cc	1993	73	AC/MO	KA-5180B
KX-250 Big Bore to 295cc	1994	73	AC/MO	KA-5209B
KX-250 Big Bore to 295cc	1997	73	AC/MO	KA-5321B
KX-250 Big Bore to 295cc	1998-99	73	AC/MO	KA-5350B
KX-250 Big Bore to 295cc	2000	73	AC/MO	KA-5422B
KX-250 Big Bore to 295cc	2001	73	AC/MO	KA-5481B
KDX-250	1980-81	70	AC/L	KA-794
KDX-250	1982	70	AC/L	KA-740
KDX-250	1983-84	70	AC/L	KA-795
KDX-250 Liquid-Cooled	1991-94	67.4	AC	KA-5079
KDX-250 Liquid-Cooled (Euro)	1993-94	67.4	AC	KA-7009
KE-250	1977-78	66	CI/MO	KA-622
F11-E 250	1975	68	CS/MO	KA-255
F5 350 Big Horn	1970-71	80.5	CS/MO	KA-251
KDX-400	1979-80	80	AC/L	KA-726
KX-420	1980-81	83	AC/L	KA-682
KDX-420	1981-82	83	AC/L	KA-682
KDX-450	1981-82	83	AC/L	KA-682
KX-450	1973-74	86	CS/MO	KA-193
KX-500	1983	86	AC/L	KA-797A
KX-500	1984	86	AC/L	KA-797
KX-500	1985	86	AC/MO	KA-898
KX-500 KIPS Liquid-Cooled	1986-87	86	AC/MO	KA-956
KX-500 KIPS Liquid-Cooled	1988	86	AC	KA-5008
KX-500 Liquid-Cooled	1989-04	86	AC	KA-5087
KX-500 Big Bore to 540cc	1986-88	88.5	AC	KA-5008B
KX-500 Big Bore to 540cc	1989-04	88.5	AC	KA-5087B

KAWASAKI 4-STROKE

KLX-110, KLX-110R	2002-24	53	RS	KA-5493
KLX-110 Big Bore to 150cc	2002-22	61	RS/MO	KA-5493B
KLX-125	2003-06	57	CI	FL-753
KLX-140	2008-24	58	RS	KA-5697
KLX-230, KLX230R	2020-24	67	AC	KA-5825
KL-250, KLR-250 Liquid-Cooled	1984-05	74	RS	KA-5018
KL-250 Super Sherpa	2000-04	72	AC	KA-5432
KL-250 Super Sherpa	2009-10	72	AC	KA-5432
KLX-250	1979-80	70	RS	KA-663
KLX-250	1994-96	72	AC	KA-5247
KLX-250 Big Bore to 310cc	1994-96	80	AC/L	KA5247BB
KLX-250S Liquid-Cooled	2006-14	72	AC	KA-5637
KLX-250 Liquid-Cooled	2018-20	72	AC	KA-5637
KX-250F	2004-05	77	AC	KA-5530
KX-250F	2006-18	77	AC	KA-5611
KX-250	2019-24	78	AC	KA-5816
KX-250X	2021-24	78	AC	KA-5816
KX-250F Big Bore to 270cc	2004-05	80	AC	KA-5530B
KX-250F Big Bore to 270cc	2006-18	80	AC	KA-5611B
KX-250F Big Bore to 300cc	2004-13	83	AC/MO	KA-5770
KLX-300R	1997-07	78	AC	KA-5339
KLX-300R	2020-24	78	AC	KA-5339
KLX-300R Big Bore to 330cc	1997-07	83	AC/MO	KA-5339B
KLX-300, KLX-300SM	2021-24	78	AC	KA-5339
KLX-400R, SR	2003	90	AC	FL-5430
KLX-400R Big Bore to 434cc	2003	94	AC	FL-5430B
KLX-450R	2008-19	96	AC	KA-5607
KX-450F	2006-08	96	AC	KA-5607
KX-450F	2009-18	96	AC	KA-5698
KX-450	2019-23	96	AC	KA-5698
KX-450X	2021-23	96	AC	KA-5698
KLR-600	1984-87	96	RS/MO	KA-861
KL, KLR-650	1987-95	100	RS	KA-5009
KL, KLR-650	1996-18	100	RS	KA-5598
KLR-650	2022-24	100	AC	KA-5826
KLX-650R	1993-97	100	AC	KA-5226
KLX-650	1993-96	100	RS	KA-5687



DIRT BIKE SLEEVES

Current, Non Current, Vintage and Classic Models.

MODEL	Year	Size (mm)	Type	Part #
KTM 2-STROKE				
50 SX (Cyl. No. 2099)	1996	39	AC/MO	FL-5362
50 SX Air-Cooled	1998-01	39	AC	FL-5434
50 SX Air-Cooled	2002-07	39.5	AC	FL-5549
50 SX Liquid-Cooled	2002-08	39.5	AC	FL-5557
50 SX Liquid-Cooled	2009-23	39.5	AC	FL-5746
65 SX	1998-02	45	AC	FL-5393
65 SX, XC	2003-08	45	AC	FL-5550
65 SX	2009-23	45	AC	FL-5747
80 MX	1987-89	48	AC/L	FL-5156
85 SX (EURO) Cyl.#47030005000	2014-15	47	AC/L	FL-7049
85 SX, XC	2003-17	47	AC	FL-5551
85 SX, XC Big Bore to 105cc	2003-17	52	AC	FL-5551B
85 SX	2018-24	47	AC	FL-5796
85 SX Big Bore to 105cc	2018-24	52	AC	FL-5796B
105 SX, XC	2006-11	52	AC	FL-5552
125 Penton	1973-75	54	RS/L	FL-650
125 MX	1981-82	54	RS/MO	FL-7022
125 MX	1984-85	54	AC/MO	FL-920
125 MX Liquid-Cooled	1987-92	54.25	AC/MO	FL-5151
125 SX, E/XC	1993-94	54.25	AC	FL-5211
125 SX, E/XC	1995-97	54.25	AC	FL-5264
125 SX, E/XC	1998	54.25	AC	FL-5388
125 SX, E/XC	1999-00	54.25	AC	FL-5404
125 SX, E/XC	2001-03	54	AC	FL-5457
125 SX	2004-06	54	AC	FL-5553
125 SX	2007-15	54	AC	FL-5692
125 SX	2016-22	54	AC	FL-5804
125 SX	2023-24	54	AC	FL-5858
125 XC	2021-22	54	AC	FL-5804
125 XC	2023-24	54	AC	FL-5858
144 SX	2007-08	56	AC	FL-5684
150 SX, XC	2009-15	56	AC	FL-5684
150 SX, XC-W	2016-22	58	AC	FL-5805
150 XC-W TPI	2021-23	58	AC	FL-5805
175 Penton	1973-75	63.5	N/A	FL-336
200 EXC, MXC	1998-02	64	AC	FL-5394
200 XC, XC-W, EXC	2003-16	64	AC	FL-5554
250 MX	1984	71	RS/L	FL-639
250 MX (EURO)	1986	71	RS/L	FL-7008
240 MX (EURO)	1985-87	66.5	AC/MO	FL-922
250 MX	1985-87	67.5	AC/MO	FL-922
250 MX	1988	67.5	AC/MO	FL-5150
250 MX, D/XC	1989	67.5	AC/MO	FL-5169
250 ENDURO	1987-89	67.5	AC/MO	FL-5150
250 EXC	1990-92	67.5	AC	FL-5146
250 SX, EXC	1993-94	67.5	AC	FL-5212
250 SX, EXC	1995	67.5	AC	FL-5265
250 SX, EXC	1996-97	67.5	AC	FL-5299
250 SX, EXC, MXC	1998	67.5	AC	FL-5406
250 SX, EXC, MXC	1999	67.5	AC	FL-5407
250 SX, EXC, MXC	2000	66.4	AC	FL-5435
250 SX, EXC, MXC	2001	66.4	AC	FL-5458
250 SX	2002	66.4	AC	FL-5478
250 EXC, MXC	2002-03	66.4	AC	FL-5478
250 SX	2003-04	66.4	AC	FL-5555
250 EXC, MXC	2004	66.4	AC	FL-5555
250 SX, EXC, XC-W	2005-06	66.4	AC	FL-5600
250 SX, XC-W	2007-10	66.4	AC	FL-5693
250 XC	2007-11	66.4	AC	FL-5693
250 XC	2012-14	66.4	AC	FL-5748
250 SX, XC-W	2011-16	66.4	AC	FL-5748
250 SX, XC-W	2017-18	66.4	AC	FL-5785
250 XC	2018	66.4	AC	FL-5785
250 XC-W TPI	2019	66.4	AC	FL-5785
250 SX, XC	2019	66.4	AC	FL-5811
250 SX, XC TPI	2019-22	66.4	AC	FL-5811
250 XC-W TPI	2020-23	66.4	AC	FL-5811

MODEL	Year	Size (mm)	Type	Part #
KTM 2-STROKE (Continued)				
250 SX, XC	2023-24	66.4	AC	FL-5859
250 XC-W	2024	66.4	AC	FL-5859
300 EXC	1990-94	72	AC	FL-5147
300 EXC, MXC	1995	72	AC	FL-5266
300 EXC, MXC	1996	72	AC	FL-5315
300 EXC, MXC	1997-98	72	AC	FL-5408
300 EXC, MXC	1999-01	72	AC	FL-5410
300 EXC, MXC	2002-03	72	AC	FL-5521
300 EXC, MXC	2004-05	72	AC	FL-5632
300 XC-W	2006-07	72	AC	FL-5632
300 XC, XC-W	2008-11	72	AC	FL-5694
300 XC, XC-W	2012-16	72	AC	FL-5749
300 XC, XC-W	2017-18	72	AC	FL-5798
300 XC, XC TPI	2019-22	72	AC	FL-5815
300 XC-W TPI	2019	72	AC	FL-5798
300 XC-W TPI	2020-23	72	AC	FL-5815
300 XC-W	2024	72	AC	FL-5860
300 SX, XC	2023-24	72	AC	FL-5860
350 MX	1985	71	RS/MO	FL-923
350 MX	1987-90	75	AC/L	FL-5157
360 SX, EXC	1996	78	AC	FL-5411
360 SX, EXC	1997-99	78	AC	FL-5363
380 SX, EXC, MXC	1998-02	78	AC	FL-5412
440 EXC, MXC	1994-96	89	AC/MO	FL-5214
495 MX Air Cooled	1981	92	CI/MO	FL-5727
495 MX	1981	92	RS/MO	FL-5681
495 MX	1983-84	92	RS/L	FL-924
500 MX	1985-88	89	AC/L	FL-964
500 MX	1989-91	89	AC/L	FL-5148
540 D/XC	1990-92	92	AC/L	FL-5116
550 MXC	1993-96	92.25	AC/L	FL-5215
KTM 4-STROKE				
250 EXC RACING	2001-06	75	AC	FL-5558
250 SXF, EXC-F, XC-F, XCF-W	2005-09	76	AC	FL-5604
250 SX-F, XC-F	2010-12	76	AC	FL-5682
250 XCF-W	2010-13	76	AC	FL-5682
250 SX-F Big Bore to 262cc	2005-12	78	AC	FL-5604B
250 SX-F Big Bore to 278cc	2005-12	80	AC	FL-5682B
250 SX-F, XC-F	2013-22	78	AC	FL-5743
250 XCF-W	2014-16	78	AC	FL-5743
250 EXC-F	2017-23	78	AC	FL-5743
250 SX-F	2023-24	81	AC	FL-5854
350 EXC-F, XCF-W	2012-16	88	AC	FL-5734
350 EXC-F	2017-23	88	AC	FL-5745
350 SX-F, XC-F	2011-12	88	AC	FL-5734
350 SX-F, XC-F	2013-22	88	AC	FL-5745
350 SX-F, XC-F	2023-24	88	AC	FL-5745
400 SX, EXC, MXC, SXC, XC-W	2000-07	89	AC	FL-5436
400 EXC, XC-W	2009-11	95	AC	FL-5744
450 EXC	2003-07	89	AC	FL-5442
450 MXC, XC-W	2005-07	89	AC	FL-5442
450 SX	2003-06	95	AC	FL-5556
450 SMR, XC	2005-07	95	AC	FL-5556
450 EXC-R	2008-11	95	AC	FL-5556
450 SMR	2008-13	97	AC	FL-5638
450 XC-F	2008-09	97	AC	FL-5638
450 SX-F	2007-12	97	AC	FL-5638
450 SX-F	2013-15	95	AC	FL-5744
450 EXC	2010-11	95	AC	FL-5744
450 XC-W	2010-16	95	AC	FL-5744
450 XC-F	2013-16	95	AC	FL-5744
450 SX-F, XC-F	2017-24	95	AC	FL-5744
500 EXC, XC-W	2012-16	95	AC	FL-5772
500 EXC-F	2017-24	95	AC	FL-5772
500 XCF-W	2021-23	95	AC	FL-5772
505 SX-F, XC-F	2007-09	100	AC	FL-5584
520 SX, EXC, MXC	2000-07	95	AC	FL-5437

DIRT BIKE SLEEVES

Current, Non Current, Vintage and Classic Models.



MODEL	Year	Size (mm)	Type	Part #
KTM 4-STROKE (Continued)				
525 SX, EXC, MXC, XC-W	2003-07	95	AC	FL-5437
520, 525 Big Bore to 565cc	2000-07	100	AC	FL-5437B
530 EXC-R, XC-W	2008-11	95	AC	FL-5556
620 LC4, EXC	1998-01	101	AC	FL-5396
625 LC4, SXC	2002-07	101	AC	FL-5396
640 LC4 DUKE	1998-07	101	AC	FL-5396
690 ENDURO R	2008-21	102	AC	FL-5716

MAICO / M-STAR 2-STROKE				
250 Square Barrel	Pre-70's	67	RS/NA	FL-194
250 Radial	1973-75	67	RS/MO	FL-230
250 Wedge	1976-79	67	RS/MO	FL-380
250	1980	67	RS/MO	FL-715
250	1981	67	RS/MO	FL-716
250	1982	67	RS/MO	FL-745
250 Spider	1983-85	67	RS/L	FL-918
GM250	1986	67	AC/L	FL-990
MC, RC 250	1995-97	67	AC/L	FL-990
360 Round Barrel	1968	77	RS/L	FL-199
360 Square Barrel	1969	77	RS/L	FL-195
400 Early 70's Model	1970	77	RS/L	FL-197
400 Radial	1973-78	77	RS/MO	FL-298
400 Magnum	1979-80	77	RS/L	FL-648
450K WR Radial	1973-78	82	RS/MO	FL-299
450 M1	1979-80	82	RS/MO	FL-687
490	1981-82	86.5	RS/MO	FL-720
490	1983-84	86.5	RS/L	FL-825
GM, RC 500	1994-97	86.5	RS/L	FL-825
501 Early 70's Model	1970	91.6	RS/L	FL-198
505	1979-80	87.5	RS/MO	FL-5797

MONTESA 2-STROKE				
250 Cota	1971	72.5	RS/L	FL-237
250 Cota	1972	72.5	RS/NA	FL-239
250 VR Capra	1973-75	70	RS/MO	FL-244
250 VR	1977	70	RS/L	FL-623

MOTO VILLA 2-STROKE				
250	1975	70	RS/L	FL-342
450	1976	85	RS/L	FL-387

OSSA 2-STROKE				
250 Phantom GP	1976	72	RS/L	FL-382
250 Pioneer		72	N/A	FL-254
250 Stilleto MX		72	N/A	FL-245
250 TT Scrambler		72	N/A	FL-167

PUCH 2-STROKE				
125 Flanged Sleeve	70's	55	CS/L	FL-339
175 Flanged Sleeve	1973-74	62	CS/L	FL-368

SACHS 2-STROKE				
125 Penton, Monark, DKW	70's	54	RS/L	DS-295
125 Penton	1973-74	54	RS/L	FL-5794
250	1970-75	72	CS/L	FL-5353
250 Hercules	1976	71.5	RS/MO	FL-5793
340 TCR, ROKON RT	1974-75	78	RS/L	FL-327

SUZUKI 2-STROKE				
JR-50	1996-06	41	CC	FL-5492
RM-60	2003	43	AC	KA-935
RM-65	2003-06	44.5	AC	KA-5472
RM-80	1976-77	49	CI/MO	FL-632
RM-80	1981	49	CI/MO	FL-5795
RM-80	1983	49	CI	FL-800
RM-80	1984-85	49	CI	FL-5082
RM-80 G,H	1986-87	47.5	CI	FL-973
RM-80 J	1988	47.5	CS	FL-5048

MODEL	Year	Size (mm)	Type	Part #
SUZUKI 2-STROKE (Continued)				
RM-80 K,L	1989-90	47.5	CS	FL-5091
RM-80	1991-01	47.5	CS	FL-5140
RM-85	2002-21	48	AC	FL-5479
RM-85 Big Bore to 100cc	2002-21	52	AC	FL-5479B
RM-100	2003	52.5	AC	KA-5358
TS-100	1980	50	AC/MO	FL-5571
RM-125	1976	56	CI/MO	FL-634
RM-125	1977-78	54	CI/MO	FL-635
RM-125	1979-80	54	CI/MO	FL-679
RM-125 X Liquid-Cooled	1981	54	CI/L	FL-722
Heavy O.D. Repairs Broken Cyl.	1981	54	CS/MO	FL-722H
RM-125 Z, D	1982-83	54	CI/L	FL-748
Heavy O.D. Repairs Broken Cyl.	1982-83	54	CS/MO	FL-748H
RM-125 E, F	1984-85	54	CI/L	FL-900
Heavy O.D. Repairs Broken Cyl.	1984-85	54	CS/MO	FL-900H
RM-125 G	1986	54	CI/L	FL-974
Heavy O.D. Repairs Broken Cyl.	1986	54	CS/MO	FL-974H
RM-125 H	1987	54	CI/L	FL-5011
Heavy O.D. Repairs Broken Cyl.	1987	54	CS/MO	FL-5011H
RM-125 J	1988	54	CI/L	FL-5049
Heavy O.D. Repairs Broken Cyl.	1988	54	CS/MO	FL-5049H
RM-125 K	1989	54	CS/L	FL-5092
RM-125 L	1990	54	AC	FL-5106
RM-125 M,N	1991-92	54	AC	FL-5108
RM-125 (Cyl. No. 40)	1993	54	AC	FL-5181
RM-125 (Cyl. No. 50, 60, 70)	1994-96	54	AC	FL-5255
RM-125	1997	54	AC	FL-5323
RM-125	1998-99	54	AC	FL-5346
RM-125	2000-03	54	AC	FL-5420
RM-125 (Cyl. No. 36F, 36F1)	2004-10	54	AC	FL-5532
RM-125 Big Bore to 144cc	2004-10	58	AC	FL-5532B
TM-125	1974	56	N/A	FL-401
TM-125 (EURO)	1999-00	54	AC	FL-7040
185 DT, TC, TS	1974-80	64	CI/MO	FL-7037
RM-250	1975-76	70	RS/MO	FL-373
RM-250	1977-78	67	CI/MO	FL-676
RM-250 X	1981	67	CI/L	FL-751
RM-250 Z, D	1982-83	70	CI/L	FL-752
RM-250 E, F	1984-85	70	CI/MO	FL-869
RM-250 G	1986	67	CS/MO	FL-976
RM-250	1987	67	AC	FL-5012
RM-250	1988	67	AC	FL-5053
RM-250	1989-90	67	AC	FL-5093
RM-250	1991-92	67	AC	FL-5182
RM-250 (Cyl. No. 40)	1993	67	AC	FL-5182
RM-250 (Cyl. No. 50)	1994	67	AC	FL-5217
RM-250 (Cyl. No. 60)	1995	67	AC	FL-5256
RM-250	1996	66.4	AC	FL-5295
RM-250 (Cyl. No. 10)	1997	66.4	AC	FL-5324
RM-250 (Cyl. No. 20)	1998	66.4	AC	FL-5357
RM-250 (Cyl. No. 30)	1999	66.4	AC	FL-5379
RM-250 (Cyl. No. 40)	2000	66.4	AC	FL-5419
RM-250 (Cyl. No. 37F0)	2001	66.4	AC	FL-5465
RM-250 (Cyl. No. 37F1)	2002	66.4	AC	FL-5474
RM-250 (Cyl. No. 37F2)	2003	66.4	AC	FL-5494
RM-250 (Cyl. No. 37F3, 37F4)	2004-05	66.4	AC	FL-5534
RM-250 (Cyl. No. 37F5)	2006-08	66.4	AC	FL-5629
RMX-250 K, L	1991-92	67	AC	FL-5182
RMX-250	1993-98	67	AC	FL-5271
RM-250 Big Bore to 295cc	1989-90	73	AC	FL-5093B
RM-250 Big Bore to 295cc	1995	73	AC	FL-5256B
TM-250	1968	68	RS/MO	FL-5799
TM-250	1972	70	CI/MO	FL-646
RM-370	1976-77	77	CI/MO	FL-374
RM-400 (No Boost Port)	1978-79	80	CI/MO	FL-689
RM-400 (With Boost Port)	1978-79	80	CI/MO	FL-689-1
RM-400 Enduro	1980-81	85	CI/MO	FL-776
RM-465 X	1981-82	86	CI/MO	FL-755
RM-500	1983-84	88.5	CI/MO	FL-805



DIRT BIKE SLEEVES

Current, Non Current, Vintage and Classic Models.

MODEL	Year	Size (mm)	Type	Part #
SUZUKI 4-STROKE				
DR, SP 100	1983-90	51	CS	FL-802
DR-Z110	2003-06	53	RS	KA-5493
DR-Z110 Big Bore to 150cc	2003-06	61		KA-5493B
DR, SP 125	1982-97	57	CI	FL-753
DR-Z125	2003-24	57	CI	FL-753
DR, SP 200	1986-04	66	CI	FL-975
DR-200 SE	2005-13	66	AC	FL-975
DR, SP 250	1982-88	72	RS	FL-754
DR-250	1991-95	73	CI	FL-5130
DR-Z250	2001-07	73	AC	FL-5130
DR-Z250 Big Bore to 300cc	2001-07	80	AC	FL-5130B
RM-Z250	2004-18	77	AC	KA-5530
RM-Z250	2019-24	77	AC	FL-5750
RM-Z250 Big Bore to 270cc	2004-18	80	AC	KA-5530B
RM-Z250 Big Bore to 300cc	2004-18	83	AC/MO	KA-5770
DR-350	1990-99	79	CI	FL-5112
Heavy O.D. allows bore to 385cc	1990-99	79-83	CS	FL-5112H
DR-350 Big Bore to 450cc	1990-99	89	CS/MO	FL-5112B
DR-Z400 E, S	2000-24	90	AC	FL-5430
DR-Z400 Big Bore to 434-450cc	2000-24	94	AC	FL-5430B
RM-Z450	2005	95.5	AC	FL-5601
RM-Z450	2006-07	95.5	AC	FL-5628
RM-Z450 (Cyl. No. 28H0)	2008-20	96	AC	FL-5699
RMX-450Z	2017-23	96	AC	FL-5699
DR, SP 500	1982-84	88	CI/MO	FL-756
DR, SP 600	1985-89	94	RS/MO	FL-871
DR-650	1990-95	95	RS/MO	FL-5219
DR-650 S, E	1996-24	100	AC	FL-5309
LS-650	1986-98	95	RS/MO	FL-5219
V-STROM 650 V-Twin	2004-24	81	AC	FL-5421
V-Strom 650 Big Bore to 744-796	2004-24	86-90	AC	FL-5421B
V-STROM 1000 V-Twin	2003-12	98	AC	FL-5460

TM 2-STROKE

TM 125 Cross / Enduro (EURO)	2010-14	54	AC/MO	FL-7048
------------------------------	---------	----	-------	---------

YAMAHA 2-STROKE

YZ-60	1982	42	CS/MO	YA-370
YZ-65 (Cyl. No. BR8)	2018-24	43.5	AC	YA-5806
YZ-80	1974-75		N/A	YA-340
YZ-80 (Cyl. No. ITO)	1977	49	CS/MO	YA-669
YZ-80 (Cyl. No. 5X2)	1982	47	CI/MO	YA-827
YZ-80 (Cyl. No. 22W)	1983	47	CI/MO	YA-827A
YZ-80 L (Cyl. No. 39K)	1984	48	CS/MO	YA-888H
YZ-80 N (Cyl. No. 58T)	1985	48	CS/MO	YA-888H
YZ-80 S (Cyl. No. 1LR)	1986	48	CI/MO	YA-978
YZ-80 T (Cyl. No. 2HF)	1987	48	CI	YA-5056
YZ-80 V, W, B	1988-92	48	CI	YA-5056
YZ-80 (Cyl. No. 4ES)	1993-01	47	AC	YA-5183
YZ-80 Big Bore to 103cc	1993-01	52.5	AC	YA-5476B
YZ-85 (Cyl. No. 5PA)	2002-18	47.5	AC	YA-5476
YZ-85 (Cyl. No. B4B)	2019-24	47.5	AC	YA-5807
YZ-85 Big Bore to 103cc	2002-18	52.5	AC	YA-5476B
DT-100 (Cyl. No. 1T9)	1977-79	52	CI/L	YA-838
MX-100	1979-83	52	CI/L	YA-838
YZ-100	1982-83	50	CI/MO	YA-633
DT-125 (Cyl. No. 10W) EURO	1982-83	56	CI	YA-7021
DT-125 Heavy O.D. Repair Sleeve	1982-83	56	CS/MO	YA-7021H
DT-125 (Cyl. No. 1GU) EURO	1984-90	56	CI	YA-7020
DT-125 Heavy O.D. Repair Sleeve	1984-90	56	CS	YA-7020H
DT-125R (Cyl. No. 1KT) EURO	1987-92	56	CI	YA-7001
DT-125R Heavy O.D. Repair Sleeve	1987-92	56	CS/MO	YA-7001H
DT-125 (Cyl. No. 3BN) EURO	1987-92	56	CS	YA-7005
DTR-125 (Cyl. No. 3MB) EURO	1989-96	56	AC/MO	YA-7014
YZ-125	1974	56	AC/MO	YA-333
YZ-125 (Cyl. No. 537)	1975-76	56	CS/MO	YA-357
YZ-125 (Cyl. No. 1W1)	1977	56	CS/MO	YA-659

MODEL	Year	Size (mm)	Type	Part #
YAMAHA 2-STROKE (Continued)				
YZ-125 (Cyl. No. 2K6)	1978	56	CS/MO	YA-659
YZ-125 (Cyl. No. 2X3)	1979	56	CS/MO	YA-659
YZ-125 (Cyl. No. 3R3, 3N8)	1980	56	CS/MO	YA-693
YZ-125 (Cyl. No. 4V2)	1981	56	CS/MO	YA-723
YZ-125 (Cyl. No. 5X4)	1982	56	CI/MO	YA-760
YZ-125 (Cyl. No. 24X)	1983	56	CI/MO	YA-809
YZ-125 (Cyl. No. 39W)	1984	56	CI/MO	YA-874
YZ-125 (Cyl. No. 55Y)	1985	56	CI/MO	YA-875
YZ-125 (Cyl. No. 1LX)	1986	56	CS/MO	YA-979
YZ-125 (Cyl. No. 2HG)	1987	56	CS/MO	YA-5014
YZ-125 (Cyl. No. 2VN)	1988	56	CS/MO	YA-5055
YZ-125 (Cyl. No. 3JD)	1989	56	AC	YA-5094
YZ-125 (Cyl. No. 3SR)	1990	56	AC	YA-5120
YZ-125 (Cyl. No. 3XJ)	1991	56	AC	YA-5118
YZ-125 (Cyl. No. 4DB)	1992	56	AC	YA-5141
YZ-125 (Cyl. No. 4EX)	1993	56	AC	YA-5184
YZ-125 (Cyl. No. 4JY)	1994	54	AC	YA-5257
YZ-125 (Cyl. No. 4PE)	1995	54	AC	YA-5257
YZ-125 (Cyl. No. 4SS)	1996-98	54	AC	YA-5348
YZ-125 (Cyl. No. 5ET)	1999	54	AC	YA-5378
YZ-125 (Cyl. No. 5HD)	2000	54	AC	YA-5378
YZ-125 (Cyl. No. 5MV)	2001	54	AC	YA-5378
YZ-125 (Cyl. No. 5NY)	2002	54	AC	YA-5470
YZ-125 (Cyl. No. 5UN)	2003	54	AC	YA-5487
YZ-125 (Cyl. No. 5EX)	2004	54	AC	YA-5533
YZ-125 (Cyl. No. 1C3)	2005-21	54	AC	YA-5533
YZ-125 (Cyl. No. B4X)	2022-24	54	AC	YA-5857
YZ-125 Big Bore to 144cc	2005-21	58	BB/MO	YA-5533B
YZ-125X (Cyl. No. 1C3)	2020-22	54	AC	YA-5533
YZ-125X (Cyl. No. B4X)	2023-24	54	AC	YA-5857
175 CT-1	1970-71	66	CS/MO	YA-126
175 CT-2 ENDURO	1972	66	CI/L	YA-362
DT-175 (Cyl. No. 2A7)	1978	66	CI/L	YA-5344
IT-175	1977-79	66	CI/MO	YA-649
IT-175 (Cyl. No. 3R6)	1980-81	66	CI/MO	YA-811
IT-175 J, K	1982-83	66	CI/MO	YA-832
YZ-175 (Cyl. No. 1L8)	1976	66	CI/L	YA-5523
RT-180 (Cyl. No. 5L9)	1990-98	64.5	CI	YA-5134
DT-200 (Cyl. No. 3F7)	1988-89	66	CI	YA-5069
DT-200 (3F7) Big Bore to 236cc	1988-89	72	CS/L	YA-5069B
DT-200 YVPS (Cyl. No. 3ET)	1990-92	66	CI	YA-5162
DT-200 (3ET) Big Bore to 236cc	1990-92	72	CS	YA-5162B
IT-200 (Cyl. No. 43G)	1984-87	66	CS/MO	YA-876
WR-200 (Cyl. No. 3XP)	1991-95	66.8	AC	YA-5137
WR-200 Big Bore to 236cc	1991-95	72	AC	YA-5137B
IT-250	1983	68	CS/MO	YA-813
MX-250 DT-1	1968	70	CS/MO	YA-131B
MX-250 DT-1	1969	70	CS/MO	YA-160B
MX-250 DT-1	1970	70	CS/MO	YA-127B
MX-250 DT-3 (Reed Valve)	1973	70	CS/MO	YA-223
MX-250B	1975-76	70	CS/MO	YA-364
WR-250 (Cyl. No. 3JE)	1989	68	CS	YA-5095
WR-250 (Cyl. No. 3SP)	1990	68	CS	YA-5109
WR-250 (Cyl. No. 3XK)	1991	68	CS	YA-5119
WR-250 (Cyl. No. 4DA)	1992-93	68	AC	YA-5174
WR-250 (Cyl. No. 4JX)	1994-97	68	AC	YA-5258
YZ-250	1973-75	70	AC/MO	YA-352
YZ-250 D, E	1976-78	70	CI/MO	YA-658
YZ-250F (Cyl. No. 2X4)	1979	70	CI/MO	YA-678
YZ-250 G, H (Cyl. No. 3R4, 4V3)	1980-81	70	CS/MO	YA-695
YZ-250J (Cyl. No. 5X5)	1982	70	CI/MO	YA-764
YZ-250K (Cyl. No. 24Y)	1983	68	CI/MO	YA-810
Heavy O.D. Repair Sleeve	1983	68	CS/MO	YA-810H
YZ-250L (Cyl. No. 39X)	1984	68	CS/MO	YA-877
YZ-250N (Cyl. No. 56A)	1985	68	CS/MO	YA-878
YZ-250S (Cyl. No. 1LU)	1986	68	CS/L	YA-980
YZ-250T (Cyl. No. 2HH)	1987	68	CS/L	YA-5015
YZ-250U (Cyl. No. 2VM)	1988	68	CS	YA-5054

DIRT BIKE SLEEVES

Current, Non Current, Vintage and Classic Models.



MODEL	Year	Size (mm)	Type	Part #
YAMAHA 2-STROKE (Continued)				
YZ-250V (Cyl. No. 3JE)	1989	68	CS	YA-5095
YZ-250W (Cyl. No. 3SP)	1990	68	CS	YA-5109
YZ-250 (Cyl. No. 3XK)	1991	68	AC	YA-5119
YZ-250 (Cyl. No. 4DA)	1992	68	AC	YA-5174
YZ-250 (Cyl. No. 4EW)	1993	68	AC	YA-5185
YZ-250 (Cyl. No. 4JX, 4MX)	1994-95	68	AC	YA-5258
YZ-250 (Cyl. No. 4SR)	1996	68	AC	YA-5296
YZ-250 (Cyl. No. 4XL)	1997	68	AC	YA-5327
YZ-250 (Cyl. No. 4XL)	1998	68	AC	YA-5352
YZ-250 (Cyl. No. 5CU)	1999-00	66.4	AC	YA-5377
YZ-250 (Cyl. No. 5MW)	2001-02	66.4	AC	YA-5377
YZ-250 (Cyl. No. 5UP)	2003-24	66.4	AC	YA-5377
YZ-250X (Cyl. No. BF1)	2016-24	66.4	AC	YA-5377
YZ-250 Big Bore to 300cc	1999-24	72	BB/MO	YA-5377B
TY-350 N	1985-86	80	AC/L	YA-903
RT2MX-360	1972	80	CS/MO	YA-329
MX-360	1973-74	80	CS/MO	YA-224
YZ-360	1974-75	80	CS/MO	YA-332
IT-400 D,E (Cyl. No. 1W4)	1977-78	85	CI/MO	YA-765
IT-400 F (Cyl. No. 2X5)	1979	82	CI/MO	YA-5306
MX-400B	1975-76	85	CS/MO	YA-365
YZ-400C (Cyl. No. 510)	1976	85	CI/MO	YA-765
YZ-400 D, E (Cyl. No. 1W4)	1977-78	85	CI/MO	YA-765
YZ-400F (Cyl. No. 2X5)	1979	82	CI/MO	YA-5306
YZ-465 (Cyl. No. 3R5, 4V4)	1980-81	85	CS/MO	YA-698
IT-490 (Cyl. No. 26A)	1983-84	87	CS/MO	YA-5527
YZ-490 (Cyl. No. 5X6)	1982	87	CS/MO	YA-766
YZ-490 (Cyl. No. 23X)	1983	87	CS/MO	YA-766A
YZ-490 (Cyl. No. 40T)	1984-86	87	CS/MO	YA-821
YZ-490 (Cyl. No. 2HJ)	1987-90	87	CS/MO	YA-5016
SC-500	1973-74	95	CS/MO	YA-225
WR-500 (Cyl. No. 4AA)	1991-93	87	CS	YA-5138

YAMAHA 4-STROKE				
TT-R90	2000-07	47	CI	YA-5462
TT-R90 Big Bore to 110cc	2007-07	52	CC/MO	YA-5462B
TT-R110E	2008-24	51	CI	YA-5700
TT-R125	2000-24	54	RS	YA-5426
TT-R125 Big Bore to 145cc	2000-24	58	BB	YA-5426B
TW-200	1987-24	67	RS	YA-762
XT-200	1982-87	67	RS	YA-762
XT-225	1983-02	70	RS	YA-812
XT-225 (Cyl. No. 5MP, 5RK)	2001-07	70	AC	YA-5631
TT-225	1986-88	70	RS	YA-812
TT-R225	1999-04	70	RS	YA-812
TT-R230	2005-24	70	RS	YA-812
TT-R250	1999-06	73	RS	YA-5400
TT, XT-250	1980-83	75	RS/MO	YA-697
XT-250	1984-85	73	RS/MO	YA-880
XT-250	2008-23	74	AC	YA-5702
WR-250F (Cyl. No. 5NL)	2001-02	77	AC	YA-5463
WR-250F (Cyl. No. 5UL)	2003	77	AC	YA-5515
WR-250F (Cyl. No. 5XC)	2004-13	77	AC	YA-5536
WR-250F Big Bore to 270cc	2001-13	80	AC/MO	YA-5536B
WR-250F (Cyl. No. 1SM)	2015-18	77	AC	YA-5780
WR-250F (Cyl. No. B7B)	2020-24	77	AC	YA-5780
WR-250R/X (Cyl. No. 3D7)	2008-20	77	AC	YA-5701
WR-250R/X Big Bore to 275cc	2008-20	81	AC/MO	YA-5701B
YZ-250F (Cyl. No. 5NL)	2001-02	77	AC	YA-5463
YZ-250F (Cyl. No. 5UL)	2003	77	AC	YA-5515
YZ-250F (Cyl. No. 5XC)	2004-13	77	AC	YA-5536
YZ-250F (Cyl. No. 1SM)	2014-18	77	AC	YA-5780
YZ-250F (Cyl. No. B7B)	2019-24	77	AC	YA-5780
YZ-250FX (Cyl. No. 1SM)	2015-19	77	AC	YA-5780
YZ-250FX (Cyl. No. B7B)	2020-23	77	AC	YA-5780
YZ-250F Big Bore to 270cc	2001-13	80	AC/MO	YA-5536B
Big Bore 290cc Wet Liner Ductile	2001-13	83	AC/MO	YA-5732

MODEL	Year	Size (mm)	Type	Part #
YAMAHA 4-STROKE (Continued)				
XT-350, TT-350	1985-00	86	RS/L	YA-902
WR-400F	1998-00	92	AC	YA-5359
YZ-400F	1998-99	92	AC	YA-5359
WR-426F	2001-02	95	AC	YA-5424
YZ-426F	2000-02	95	AC	YA-5424
WR-450F (Cyl. No. 5TA)	2003-06	95	AC	YA-5495
WR-450F (Cyl. No. 2S2)	2007-15	95	AC	YA-5627
WR-450F (Cyl. No. 1SL)	2016-18	97	AC	YA-5728
WR-450F (Cyl. No. BR9)	2019-20	97	AC	YA-5728
WR-450F (Cyl. No. B2W)	2021-23	97	AC	YA-5728
WR-450F (Cyl. No. BHR)	2024	97	AC	YA-5728
YZ-450F (Cyl. No. 5TA)	2003-05	95	AC	YA-5495
YZ-450F (Cyl. No. 2S2)	2006-09	95	AC	YA-5627
YZ-450F (Cyl. No. 33D)	2010-13	97	AC	YA-5728
YZ-450F (Cyl. No. 1SL)	2014-17	97	AC	YA-5728
YZ-450F (Cyl. No. BR9)	2018-19	97	AC	YA-5728
YZ-450F (Cyl. No. B2W)	2020-22	97	AC	YA-5728
YZ-450F (Cyl. No. BHR)	2023-24	97	AC	YA-5728
YZ-450FX (Cyl. No. 1SL)	2016-18	97	AC	YA-5728
YZ-450FX (Cyl. No. BR9)	2019-20	97	AC	YA-5728
YZ-450FX (Cyl. No. B2W)	2021-23	97	AC	YA-5728
YZ-450FX (Cyl. No. BHR)	2024	97	AC	YA-5728
XT-500, TT-500	1975-81	87	RS/L	YA-375
XT-500, TT-500 Big Bore to 535cc	1975-81	90	BB/MO	YA-375B
Big Bore to 600cc	1975-81	95	BB/MO	YA-375BB
XT-550	1982-83	92	RS/MO	YA-768
TT-600 Sleeve O.D. 4.035"	1983-96	95	AC/RS	YA-814
XT-600 Sleeve O.D. 4.035"	1984-96	95	AC/RS	YA-814
Tenere 600 Sleeve O.D. 4.035"	1984-96	95	AC/RS	YA-814
XT, TT 600 O.D. 4.125" Big Bore	1983-96	95-98	AC/BB	YA-814BB
XT, TT 600 Big Bore to 101mm	1983-96	101	BB/MO	YA-7028
XTZ-660 Tenere (Euro)	1991-97	100	RS	YA-7018

YAMAHA GOLF CART 4-STROKE				
Golf Cart Single Air Cooled (JN5)		75mm	AC	YA-5572

ZUNDAPP 2-STROKE				
125	1970	54	AC/L	FL-164
125 with Intake Boost Port	1970	54	AC/L	FL-165
125	1972	54	AC/L	FL-268
125	1973	54	AC/L	FL-269



ALL PURPOSE SLEEVES

ALL PURPOSE SLEEVES - NO FLANGE

Cylinder I.D.	3/32" Wall		1/8" Wall		Overall Length	Cylinder I.D.	3/32" Wall		1/8" Wall		Overall Length
	Part No.	O.D.	Part No.	O.D.			Part No.	O.D.	Part No.	O.D.	
1-3/8"	LA-106	1-9/16"	L-106	1-5/8"	4-1/2"	2-3/4"	LA-212	2-15/16"	L-212	3"	8-1/4"
1-7/16"	LA-107	1-5/8"	L-107	1-11/16"	4-1/2"	2-13/16"	LA-213	3"	L-213	3-1/16"	8-1/4"
1-1/2"	LA-108	1-11/16"	L-108	1-3/4"	4-1/2"	2-7/8"	LA-214	3-1/16"	L-214	3-1/8"	8-1/4"
1-9/16"	LA-109	1-3/4"	L-109	1-13/16"	4-1/2"	2-15/16"	LA-215	3-1/8"	L-215	3-3/16"	8-1/4"
1-5/8"	LA-110	1-13/16"	L-110	1-7/8"	6-1/2"	3"	LA-300	3-3/16"	L-300	3-1/4"	8-1/4"
1-11/16"	LA-111	1-7/8"	L-111	1-15/16"	6-1/2"	3-1/16"	LA-301	3-1/4"	L-301	3-5/16"	8-1/4"
1-3/4"	LA-112	1-15/16"	L-112	2"	6-1/2"	3-1/8"	LA-302	3-5/16"	L-302	3-3/8"	9-1/4"
1-13/16"	LA-113	2"	L-113	2-1/16"	6-1/2"	3-3/16"	LA-303	3-3/8"	L-303	3-7/16"	9-1/4"
1-7/8"	LA-114	2-1/16"	L-114	2-1/8"	6-1/2"	3-1/4"	LA-304	3-7/16"	L-304	3-1/2"	9-1/4"
1-15/16"	LA-115	2-1/8"	L-115	2-3/16"	6-1/4"	3-5/16"	LA-305	3-1/2"	L-305	3-9/16"	9-1/4"
2"	LA-200	2-3/16"	L-200	2-1/4"	6-1/4"	3-3/8"	LA-306	3-9/16"	L-306	3-5/8"	9-1/4"
2-1/16"	LA-201	2-1/4"	L-201	2-5/16"	6-1/4"	3-7/16"	LA-307	3-5/8"	L-307	3-11/16"	9-1/4"
2-1/8"	LA-202	2-5/16"	L-202	2-3/8"	6-1/4"	3-1/2"	LA-308	3-11/16"	L-308	3-3/4"	9-1/4"
2-3/16"	LA-203	2-3/8"	L-203	2-7/16"	6-1/4"	3-9/16"	LA-309	3-3/4"	L-309	3-13/16"	9-1/4"
2-1/4"	LA-204	2-7/16"	L-204	2-1/2"	6-1/4"	3-5/8"	LA-310	3-13/16"	L-310	3-7/8"	9-1/4"
2-5/16"	LA-205	2-1/2"	L-205	2-9/16"	6-1/4"	3-11/16"	LA-311	3-7/8"	L-311	3-15/16"	9-1/4"
2-3/8"	LA-206	2-9/16"	L-206	2-5/8"	6-1/4"	3-3/4"	LA-312	3-15/16"	L-312	4.00"	10-1/4"
2-7/16"	LA-207	2-5/8"	L-207	2-11/16"	6-1/4"	3-13/16"	LA-313	4.00"	L-313	4-1/16"	10-1/4"
2-1/2"	LA-208	2-11/16"	L-208	2-3/4"	6-1/4"	3-7/8"	LA-314	4-1/16"	L-314	4-1/8"	10-1/4"
2-9/16"	LA-209	2-3/4"	L-209	2-13/16"	6-1/4"	3-15/16"	LA-315	4-1/8"	L-315	4-3/16"	10-1/4"
2-5/8"	LA-210	2-13/16"	L-210	2-7/8"	6-1/4"	4.00"	LA-400	4-3/16"	L-400	4-1/4"	10-1/4"
2-11/16"	LA-211	2-7/8"	L-211	2-15/16"	8-1/4"	4-1/16"	LA-401	4-1/4"	L-401	4-5/16"	10-1/4"

Sleeve has bore stock to allow boring to cylinder I.D. listed

ALL PURPOSE FLANGED SLEEVES

Cylinder	I.D.*	O.D.	Flange O.D.	Flange Thickness	Overall Length	Part No.
47mm	1.850"	2.100"	2.225"	.200"	5.250"	FL-47
48mm	1.890"	2.140"	2.265"	.200"	5.250"	FL-48
49mm	1.930"	2.180"	2.305"	.200"	5.250"	FL-49
50mm	1.968"	2.220"	2.345"	.200"	5.250"	FL-50
52mm	2.047"	2.297"	2.422"	.200"	5.250"	FL-52
54mm	2.125"	2.375"	2.500"	.200"	5.250"	FL-54
56mm	2.205"	2.455"	2.580"	.200"	5.250"	FL-56
58mm	2.283"	2.530"	2.655"	.200"	6"	FL-58
60mm	2.362"	2.625"	2.750"	.200"	6"	FL-60
62mm	2.441"	2.690"	2.815"	.200"	6"	FL-62
64mm	2.520"	2.770"	2.895"	.200"	6"	FL-64
65mm	2.559"	2.810"	2.935"	.200"	6"	FL-65
66mm	2.598"	2.850"	2.975"	.200"	6"	FL-66
67mm	2.637"	2.890"	3.015"	.200"	6"	FL-67
68mm	2.677"	2.930"	3.055"	.200"	6"	FL-68
70mm	2.755"	3.005"	3.130"	.200"	6"	FL-70
72mm	2.835"	3.085"	3.210"	.200"	6"	FL-72
73mm	2.874"	3.125"	3.250"	.200"	6"	FL-73
74mm	2.913"	3.165"	3.290"	.200"	6"	FL-74
75mm	2.952"	3.200"	3.325"	.200"	6.500"	FL-75
76mm	2.992"	3.250"	3.375"	.200"	6.500"	FL-76
78mm	3.070"	3.320"	3.445"	.200"	6.500"	FL-78
80mm	3.150"	3.400"	3.525"	.200"	6.500"	FL-80
82mm	3.228"	3.480"	3.605"	.200"	6.500"	FL-82
83mm	3.267"	3.520"	3.645"	.200"	6.500"	FL-83
84mm	3.307"	3.560"	3.685"	.200"	6.500"	FL-84
86mm	3.386"	3.635"	3.760"	.200"	6.500"	FL-86
88mm	3.464"	3.715"	3.840"	.200"	6.500"	FL-88
89mm	3.503"	3.755"	3.880"	.200"	6.500"	FL-89
90mm	3.543"	3.795"	3.920"	.200"	6.500"	FL-90
92mm	3.622"	3.875"	4.000"	.200"	6.500"	FL-92
94mm	3.700"	3.955"	4.080"	.200"	6.500"	FL-94
98mm	3.858"	4.110"	4.235"	.200"	6.500"	FL-98
100mm	3.937"	4.190"	4.315"	.200"	6.500"	FL-100

*Sleeve has bore stock to allow boring to cylinder I.D. listed
 Special flanged sleeves without ports and blank sleeves made to customer's specifications.
 Allow 6 weeks for delivery.



STREET BIKE

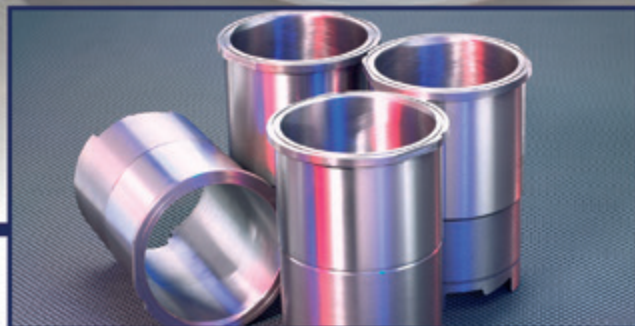



VINTAGE STREET BIKE SLEEVES

Vintage Street Bike Sleeves are Non-Stocking Items. Made to Order. Call for Pricing and Availability.

MODEL	Year	Size (mm)	Type	Part #
ARIEL				
500 Single		82mm	4-Cycle, RS	FL-134
Square 4		65mm	4-Cycle, RS	FL-184

BMW				
R50/56 (.062" wall)		67mm	4-Cycle, CC	T-170
R60/5 (.062"/.093" wall)		73.5mm	4-Cycle, CS	T/LA-171
R60/69 (.062"/.093"/.125" wall)	To 1969	72mm	4-Cycle, CC	T/LA/L-481
R75/5 (.093" wall)		82mm	4-Cycle, CC	LA-172
R75/5 (.093" wall) Flanged Type Sleeve		82mm	4-Cycle, CC	LA-172FL
R80ST	1983-87	84.8mm	4-Cycle, CS	FL-905
R90/6 & F (.093" wall)		90mm	4-Cycle, CI	LA-485
R90/6 & F (Flanged for AC Bore)	1975	90mm	4-Cycle, AC	FL-485
R100RS	1977-80	94mm	4-Cycle, CS	FL-906
R100RS	1981-95	94mm	4-Cycle, AC	FL-906

BSA				
A7 (.062"/.093" wall)		66mm	4-Cycle, CC	T/LA-482A
A-10 Old Model (.062"/.093" wall)		70mm	4-Cycle, CC	T/LA-177
Royal Star (.062"/.093" wall)		65.5mm	4-Cycle, CC	T/LA-174
650 - A-65 (.062"/.093"/.125" wall)		75mm	4-Cycle, CC	T/LA/L-175
Rocket 3/A-75 Triple		67mm	4-Cycle, RS	FL-176
Starfire/Victor B-25 Twin		67mm	4-Cycle, RS	FL-180
B-25 Twin Spigot Top Flange	1969 on	67mm	4-Cycle, RS	FL-187
B-44 Round Barrel Single		79mm	4-Cycle CS	FL-5850
Victor Round Barrel Single	1966-67	79mm	4-Cycle, RS	FL-186
Victor 440 Single Round Barrel	1968	82.5mm	4-Cycle, CI	FL-5725
Victor Special (.062"/.093" wall)		79mm	4-Cycle, CC	T/LA-173
B-33 (.062"/.093" wall)		85mm	4-Cycle, CC	T/LA-165
Goldstar Single (5 5/8" OAL)		85mm	4-Cycle, RS	FL-182
Goldstar Single (6" OAL)		85mm	4-Cycle, RS	FL-248

CZ - ESO - JAWA				
Speedway 500		88mm	4-Cycle, RS	FL-267
Jawa 500		94mm	4-Cycle, AC	FL-5736

DUCATI				
125 Single	1959	55mm	4-Cycle, RS	FL-5576
160 Monza Jr	1966	61mm	4-Cycle, RS	FL-192
175 SS	1957	62mm	4-Cycle, RS	FL-323
250	1958-62	69mm	4-Cycle, RS	FL-5729
250	1968-73	74mm	4-Cycle, RS	FL-5246
350	1966	76mm	4-Cycle, RS	FL-5468
TT2 600	1984	81mm	4-Cycle, AC	FL-914
750GT / SS (OAL 5.450")	1973-74	80mm	4-Cycle, RS	FL-822
750GT / SS (OAL 5.620")	1973-74	80mm	4-Cycle, RS	FL-5786
900 Twin	1977-78	86mm	4-Cycle, RS	FL-5371

MODEL	Year	Size (mm)	Type	Part #
ENFIELD				
650 (.062" wall)		70mm	4-Cycle, CC	T-177
750 (.062" wall)		71mm	4-Cycle, CC	T-161

HARLEY DAVIDSON				
45 (.062"/.093"/.125" wall)		2.750"	4-Cycle, CC	T/LA/L-212H
61 (.062"/.093"/.125" wall)		3.312"	4-Cycle, CC	T/LA/L-607H
80 Flat Head (.062"/.093" wall)	1936	3.422"	4-Cycle, CC	T/LA-701H
Stroker 74 (.062"/.093" wall)		3.437"	4-Cycle, CC	T/LA-38X
Sprint SX350		74mm	4-Cycle, RS	FL-294
XR750	1974-93	3.125"	4-Cycle, RS	FL-354
XR1000		3.125"	4-Cycle, RS	FL-5133
Sportster 900 H & CH (.062"/.093"/.125" wall)		3.00"	4-Cycle, CC	T/LA/L-30H
XLCH 1000 Sportster 1/16" Wall Flanged Top Sleeve		3.188"	4-Cycle, CC	FL-603H-1
XLCH 1000 Sportster 3/32" Wall Flanged Top Sleeve		3.188"	4-Cycle, CC	FL-603H-2
XLCH 1000 Sportster (.062"/.093"/.125" wall) Non Flanged Type Sleeve		3.188"	4-Cycle, CC	T/LA/L-603H

HONDA				
CL / CB / SL100		50mm	4-Cycle, RS	H-17
XL, CB125	1977-83	56.5mm	4-Cycle, RS	H-2
SL 125		56mm	4-Cycle, RS	H-21
SS/CL 125 Twin		40mm	4-Cycle, RS	H-16
CA/CB 160 Twin		50mm	4-Cycle, RS	H-10
CA/CL 175 Twin		52mm	4-Cycle, RS	H-14
Scrambler 250		54mm	4-Cycle, RS	H-11
305 CA-77 / CB-77 Twin		60mm	4-Cycle, RS	H-12
CL / CB350 Twin		64mm	4-Cycle, RS	H-13
CB350 4 Cyl.		47mm	4-Cycle, RS	H-87
CB360 Twin	1975-78	67mm	4-Cycle, RS	H-80
CB400 T / T2 / A Twin	1977-80	70.5mm	4-Cycle, RS	H-4
CB400 Four		51mm	4-Cycle, RS	H-86
CB500 Four	1971-73	56mm	4-Cycle, RS	H-23
CB550 Four	1975-78	58.5mm	4-Cycle, RS	H-81
CB750 Four	1973-77	61mm	4-Cycle, RS	H-15
CB750 Big Bore	1973-77	67mm	4-Cycle, RS	H-26
CB750 Big Bore	1973-77	70mm	4-Cycle, RS	H-400

INDIAN				
Chief (.062"/.093" wall)		3.250"	4-Cycle, CC	T/LA-34R
Chief Ductile Iron (.062" wall)		3.250"	4-Cycle, CC	T-34RD
Scout (.062"/.093" wall)		2.875"	4-Cycle, CC	T/LA-214R
Scout Ductile Iron (.062" wall)		2.875"	4-Cycle, CC	T-214RD

VINTAGE STREET BIKE SLEEVES



Vintage Street Bike Sleeves are Non-Stocking Items. Made to Order. Call for Pricing and Availability.

MODEL	Year	Size (mm)	Type	Part #
KAWASAKI				
KL250	1978-83	70mm	4-Cycle, RS	KA-663
250 F11 Series	1973-75	68mm	2-Cycle, CS	KA-255
KZ400 Twin	1974-79	64mm	4-Cycle, RS	KA-344
400 Triple	1974	57mm	2-Cycle, CS	KA-644
500 H-1 Triple		60mm	2-Cycle, CS	KA-684
H-2 750 Triple	1971-73	71mm	2-Cycle, CS	KA-325
H-2 750 Triple	1974	71mm	2-Cycle, CS	KA-5814
H-2 750 Triple	1975	71mm	2-Cycle, CS	KA-5817
Z-1 900 Four	1973-79	66mm	4-Cycle, RS	KA-250
KZ750 Twin	1976-83	78mm	4-Cycle, RS	KA-626

LAVERDA				
750 SF	1974-75	80mm	4-Cycle, RS	FL-385
1000	1974-82	75mm	4-Cycle, RS	FL-645

MATCHLESS				
G80	1964	86mm	4-Cycle	FL-5486
G80 Heavyweight Long Stroke	1957-64	82.5mm	4-Cycle	FL-5522

MOTO-GUZZI				
Falcon 500 Blue	1951	88mm	4-Cycle, RS	FL-5783
V-50 Monza Twin	1974-82	74mm	4-Cycle, AC	FL-747
700 Twin		80mm	4-Cycle, AC	FL-347
750 / 850 Ambassador VT		83mm	4-Cycle, AC	FL-183
750 / 850 Big Bore Sleeve		88mm	4-Cycle, AC	FL-369
Le Mans 850 Twin		83mm	4-Cycle, RS	FL-665
Le Mans V-1000 Twin	1976-83	88mm	4-Cycle, RS	FL-378
1000S, SP Twin	1990-93	88mm	4-Cycle, RS	FL-995

NORTON				
500 (.062"/.093" wall)		66mm	4-Cycle, CC	T/LA-482
500 Manx Short Stroke	1962	86mm	4-Cycle, CC	FL-5529
650 (.062"/.093" wall)		68mm	4-Cycle, CC	T/LA-142
Commando 750 (.062"/.093"/.125" wall)		73mm	4-Cycle, CC	T/LA/L-214C
Commando 850 (.062"/.093" wall)	1973	77mm	4-Cycle, CC	T/LA-143
Dunstall - Norton 810 Twin		76mm	4-Cycle, RS	FL-227

SUZUKI				
DR, SP370	1978-79	85mm	4-Cycle, RS	FL-666
DR, SP400	1980-82	88mm	4-Cycle, RS	FL-690
GS425 Twin	1978-79	67mm	4-Cycle, RS	FL-667
GS750 Four	1977-79	65mm	4-Cycle, RS	FL-637
GT750 Triple (Left, Center)	1974-76	70mm	2-Cycle, AC	FL-383
GT750 Triple (Right)	1974-76	70mm	2-Cycle, AC	FL-384

MODEL	Year	Size (mm)	Type	Part #
TRIUMPH				
Trophy 250 Twin		67mm	4-Cycle, RS	FL-180
250 Spigot Flange	1969 on	67mm	4-Cycle, RS	FL-187
500 Twin (.093" wall)	1946-49	63mm	4-Cycle, CC	LA-480A
500 Twin (.062"/.093"/.125" wall)	1964-73	69mm	4-Cycle, CC	T/LA/L-290
500 Twin Old Model Flanged Type Sleeve		63mm	4-Cycle, RS	FL-185
500 B-50 Single		84mm	4-Cycle, RS	FL-234
B-50 Big Bore		89mm	4-Cycle, RS	FL-328
650 Bonneville Twin Flanged Type Sleeve		71mm	4-Cycle, CC	FL-5245
650 Bonneville Twin (.062"/.093"/.125" wall)		71mm	4-Cycle, CC	T/LA/L-291
Bonneville Twin Flanged Type Sleeve		73mm	4-Cycle, RS	FL-5864
Rickman Triumph				
750 Triple		67mm	4-Cycle, RS	FL-176
750 Bonneville Twin (.062"/.093"/.125" wall)		76mm	4-Cycle, CC	T/LA/L-483

VELOCETTE				
Velo 500 (.093 wall)		86mm	4-Cycle, CI	LA-162
Venom 500 Single	1955-70	86mm	4-Cycle, RS	FL-5819

VINCENT				
Vincent		3.312"	4-Cycle, RS	FL-188

WESTLAKE				
500		85.6mm	4-Cycle, RS	FL-724

YAMAHA				
TZ125	1978-79	56mm	2-Cycle, AC	YA-694
XT125	1982-84	57mm	4-Cycle, RS	YA-761
TZ250 Twin	1978-79	54mm	2-Cycle, AC	YA-696
RD350 Twin	1973-75	64mm	2-Cycle, CS	YA-350
350 R5 Twin		64mm	2-Cycle, RS	YA-363
RD400 Twin	1976-78	64mm	2-Cycle, CS	YA-641
RD400 Daytona	1979	64mm	2-Cycle, CS	YA-882
XS750 3 Cyl.	1976-79	68mm	4-Cycle, RS	YA-642
TX750 Twin		80mm	4-Cycle, RS	YA-351

GASGAS
HONDA
HUSQVARNA
KAWASAKI
KTM
SUZUKI
YAMAHA
DIRT BIKE SLEEVES
STREET BIKE SLEEVES
ACCESSORIES
TECHNICAL

MODEL	Year	Size (mm)	Type	Part #
APRILIA/ROTAX				
125	1986-88	54mm	2-Stroke, RS/MO	FL-7023
125 AFI	1989-94	54mm	2-Stroke, AC/MO	FL-7003
125 Extrema "Rave" (European, No. 2200)	1995-96	54mm	2-Stroke, AC/MO	FL-7019
Pegaso 650	1999-05	100mm	4-Stroke, AC/MO	FL-7035
RSV1000 V-Twin (Rotax V990)	1999-11	97mm	4-Stroke, AC/MO	FL-5680
RSV1000 Big Bore 1050cc	1999-11	100mm	4-Stroke, AC/MO	FL-5680B

BMW (Flange Type Sleeves)				
F-650, G-650 Single	1995-07	100mm	4-Stroke, AC	FL-5329
F800 Twin Liquid-Cooled	2007-18	82mm	4-Stroke, AC	FL-5639
F750 GS Inline Twin (853cc)	2018-23	84mm	4-Stroke, AC	FL-5828
F850 GS Inline Twin (853cc)	2018-23	84mm	4-Stroke, AC	FL-5828
R-100RS	1981-95	94mm	4-Stroke, AC/MO	FL-906
K-1100RS, LT	1993-97	70.5mm	4-Stroke, MO	FL-5195
R-1100R, RT, RS, S	1994-05	99mm	4-Stroke, AC/MO	FL-5228
K1200 GT, LT, R, S 4 Cyl.	2005-09	79mm	4-Stroke, AC	FL-5641
R1200 Boxer Twin HP2 Enduro, GS, RT, RnineT	2007-21	101mm	4-Stroke, AC	FL-5640
R1250 Boxer Twin GS, R, RS, RT	2018-24	102.5mm	4-Stroke, AC	FL-5829

CAGIVA				
125 Mito Racing, Super City (European, No. 279) "Rave"		56mm	2-Stroke, AC/MO	FL-7025
125 Mito II "Rave" (European, No. 279A)		56mm	2-Stroke, AC/MO	FL-7026
125 Mito Replica II	1993			
125 Mito Replica II EV (European, No. 279B) "Rave"	1994-95			
125 Mito EV, RG, SP	1995-01			
125 Supercity	1995-01			
125 Planet (European, No. 279E) "Rave"	1995-01	56mm	2-Stroke, AC/MO	FL-7027

DUCATI				
500	1978-89	78mm	4-Stroke, RS/MO	FL-5068
Pantah 600	1981-83	80mm	4-Stroke, AC/MO	FL-729
Paso 750 F-1	1985-95	88mm	4-Stroke, AC/MO	FL-5060
851-888	1989-92	92mm	4-Stroke, AC/MO	FL-5097
900 R, SD	1980-82	85mm	4-Stroke, RS/MO	FL-721
900 SS, GT	1982-83	85mm	4-Stroke, RS/MO	FL-721
906 Paso, 907 I.E.	1989-93	92mm	4-Stroke, AC/MO	FL-5098
900 Super Sport	1993-97	92mm	4-Stroke, AC/MO	FL-5196
916 SP	1994-96	94mm	4-Stroke, AC/MO	FL-5340
998R/999R Testastretta Twin Ductile Iron Flanged Sleeve	2002-06	104mm	4-Stroke, AC/MO	FL-5740
1000 SS DS S2R Twin Air-Cooled	2003-08	94mm	4-Stroke, AC/MO	FL-5735
1000 SS S4R Twin Liquid-Cooled	2003-10	94mm	4-Stroke, AC/MO	FL-5719

DUCATI BIG BORE				
1000 SS DS S2R Twin to 1170cc	2003-08	102mm	4-Stroke, AC/MO	FL-5735B
1000 SS S4R LC Twin to 1100cc	2003-10	100mm	4-Stroke, AC/MO	FL-5719B

HARLEY-DAVIDSON (Flange Type Sleeves)				
Street 750 Revolution X V-Twin	2014-21	3.350"	4-Stroke, CI	FL-5830
Street Rod 750 HO Revolution X	2017-21	3.400"	4-Stroke, CI	FL-5831
XR-750 Twin	1974-93	3.125"	4-Stroke, RS/MO	FL-354
XR-1000 Twin		3.125"	4-Stroke, RS/MO	FL-5133
Sportster 900 3-1/8" O.D.		76.2mm	4-Stroke, CC/MO	FL-30H-1
Sportster 900 3-3/16" O.D.		76.2mm	4-Stroke, CC/MO	FL-30H-2
XLH 883 Sportster Evolution	1985-22	76.2mm	4-Stroke, CI/MO	FL-30H-3
Revolution V-Rod Twin 1130cc Finish Honed Bore	2001-08	100mm	4-Stroke RS/MO	FL-5603

MODEL	Year	Size (mm)	Type	Part #
HARLEY-DAVIDSON (Flange Type Sleeves) (Continued)				
FL, FLH, Panhead, Shovelhead 3-9/16" O.D.	1974	3.438"	4-Stroke, CC/MO	FL-38H-1
FL, FLH, Panhead, Shovelhead 3-5/8" O.D.		3.438"	4-Stroke, CC/MO	FL-38H-2
XLH 1200 Evolution	1985-22	88.9mm	4-Stroke, CS	FL-708H-1
XL 1200 Sportster Evolution	1985-22	88.9mm	4-Stroke, CS	FL-708H-1
XR 1200 Sportster, Roadster	2009-21	88.9mm	4-Stroke, CS	FL-708H-1
Revolution V-Rod VRSC V-Twin 76 C.I. 1250cc Finish Honed Bore	2005-13	105mm	4-Stroke, RS	FL-5414
FLT, FXB, FXRS 1340 Twin Shovelhead, "80"	1978-84	88.9mm	4-Stroke, CC	FL-708H
FL, FXD Evolution 1340 Big Twin	1985-99	88.8mm	4-Stroke, CS	FL-5330
Twin Cam 88 1450cc	1999-06	95.25mm 3.750"	4-Stroke, CI	FL-5386
Twin Cam 96	2007-16	95.25mm 3.750"	4-Stroke, CI	FL-5642
Twin Cam 110	2009-16	101.6mm 4.00"	4-Stroke,	FL-5704
Milwaukee Eight 107 C.I. V-Twin	2016-21	3.937"	4-Stroke, CI	FL-5832
Milwaukee Eight 114 C.I. V-Twin	2016-24	4.016"	4-Stroke, CI	FL-5833
Milwaukee Eight 117 C.I. V-Twin	2016-24	4.075"	4-Stroke, CI	FL-5824

HARLEY-DAVIDSON (Straight Type Sleeves)				
Electra Glide 74 1/16" Wall		3.437"	CC	T-38H
Electra Glide 74 3/32" Wall		3.437"	CC	LA-38H
FLT, FXB, FXRS, 1340 Twin, Shovelhead "80"	1978-84	88.8mm	CC	T-708H

HARLEY-DAVIDSON BIG BORE				
XLH-883 Sportster Evolution	1985-22	89mm	4-Stroke, CS	FL-708H1
Revolution V-Rod to 1320cc	2002-08	108mm	4-Stroke, CS/MO	FL-5590
Evolution 1340 to 1438cc	1985-99	92.1mm	4-Stroke, CS/MO	FL-5113
S&S 1438cc Evolution Big Bore	1985-99	92.1mm	4-Stroke, CC/MO	FL-5270
Evolution 1340 to 1540cc	1985-99	96.82mm	4-Stroke, CS/MO	FL-5588
Twin Cam 88 to 1560cc	1999-06	3.875"	4-Stroke, CI/MO	FL-5386B
Twin Cam 88 to 1650cc	1999-06	101.6mm	4-Stroke, CS/MO	FL-5589
Milwaukee Eight to 124 C.I.	2016-24	4.250"	4-Stroke, CS/MO	FL-5824B
Milwaukee Eight to 128 C.I.	2016-24	4.312"	4-Stroke, CS/MO	FL-5824B

HONDA				
MB-5		39mm	2-Stroke, CI	H-837
MB-5, Big Bore		42.5mm	Big Bore, CS/MO	H-837B
EZ-90 Cub	1991-97	48mm	2-Stroke, NA	H-5126
CM-90, S-90, CL-90		50mm	4-Stroke, CC/MO	H-9
NS-125 (European)	1988-90	56mm	2-Stroke, AC/MO	H-7002
NS-125R (European)	1991-95	54mm	2-Stroke, AC/MO	H-7004
NX-125	1988-89	56.5mm	4-Stroke, MO	H-5038
NX-125 (European)		59.5mm	2-Stroke, AC/MO	H-7012
CM-200 Twin	1980-83	53mm	4-Stroke, RS/MO	H-95
CBR-250R	2012-13	76mm	4-Stroke, AC	H-5742
CRF-250L	2013-20	76mm	4-Stroke, AC	H-5742
CM-250 Rebel Twin	1982-87, 1994-07			
CB250T Nighthawk Twin	1990-07	53mm	4-Stroke, RS/MO	H-107
CN-250G Helix	1986-01	72mm	4-Stroke, RS/MO	H-959
NX-250	1988-90	70mm	4-Stroke, AC	H-5039
CB-350 Four		47mm	4-Stroke, RS/MO	H-87
CB-400 Four		51mm	4-Stroke, RS/L	H-86
CB-400F, CB-1 Four	1989-90	55mm	4-Stroke, RS/MO	H-5100
CB, CM-450 Rebel	1981-89	75mm	4-Stroke, RS	H-108
CRF-450RL	2019-24	96mm	4-Stroke, AC	H-5801
GB-500	1989-90	92mm	4-Stroke, RS	H-839
Shadow VLX 583cc V-Twin	2006-07	75mm	4-Stroke, MO	H-5653
CBR-600 F Four	1987-90	63mm	4-Stroke, RS	H-5004

STREET BIKE SLEEVES



GASGAS

HONDA

HUSQVARNIA

KAWASAKI

KTM

SUZUKI

YAMAHA

DIRT BIKE SLEEVES

STREET BIKE SLEEVES

ACCESSORIES

TECHNICAL

MODEL	Year	Size (mm)	Type	Part #
HONDA (Continued)				
CBR-600 F2, F3	1991-98	65mm	4-Stroke, RS	H-5127
CBR-600 F4 4-Cyl.	1999-06	67mm	4-Stroke, CI	H-5382
CBR-600 RR	2003-06	67mm	4-Stroke, CI	H-5834
CB-650 Four	1979-82	60mm	4-Stroke, RS/MO	H-7
CB-650 SC Four	1983-85	60mm	4-Stroke, RS/MO	H-122
CB-650F 4-Cyl.	2018-21			
CB-650R 4-Cyl.	2018-23			
CBR-650F 4-Cyl.	2014-18			
CBR-650R 4-Cyl.	2019-23	67mm	4-Stroke, CI	H-5835
Hawk GT-650 Twin	1988-91	79mm	4-Stroke, CI	H-5128
NX-650 Dominator	1988-96	100mm	4-Stroke, RS	H-5160
XR-650L	1993-24	100mm	4-Stroke, RS	H-5160
CB-700 SC Four	1984-86	67mm	4-Stroke, RS	H-848
CTX-700 Twin	2014-18	73mm	4-Stroke, CI/MO	H-5752
NC-700X Twin	2012-18	73mm	4-Stroke, CI/MO	H-5752
NT-700V V-Twin	2010-11	81mm	4-Stroke, MO	H-5705
V-45	1982-86			
VF-700CF	1984-87	70mm	4-Stroke, CI	T-212HO
VT-700C	1985-87	76.5mm	4-Stroke, CI	FL-30H1
CB-750F	1978-83	62mm	4-Stroke, RS/MO	H-28
CBX-750 4-Cyl.	1984-85	67mm	4-Stroke, RS/MO	H-849
CB-750 Nighthawk	1986-03	67mm	4-Stroke, RS/MO	H-849
Shadow VT750 V-Twin	2006-22	79mm	4-Stroke	H-5654
NC-750X Twin	2018-24	77mm	4-Stroke, CI	H-5836
Interceptor 800 V-4	2008-09	72mm	4-Stroke, MO	H-5706
CB-900 4-Cyl.	1979-83	64.5mm	4-Stroke, RS	H-97
CB-900F 4-Cyl.	2002-03	71mm	4-Stroke, CI	H-5516
CBR-900RR 4-Cyl.	1993-95	70mm	4-Stroke, CS	H-5199
919 4-Cyl.	2003-07			
CBR-900RR	1996-99	71mm	4-Stroke, CI	H-5331
CBR-929RR 4-Cyl.	2000-01	74mm	4-Stroke, AC	H-5441
CBR-954RR 4-Cyl.	2002-03	75mm	4-Stroke	H-5517
CBX-1000 6-Cyl.		64.5mm	4-Stroke, RS/L	H-6
CB-1000 4-Cyl.	1983-84	67mm	4-Stroke, RS/MO	H-117
CBR-1000 4-Cyl.	1987-94			
CB-1000 4-Cyl.	1993-95	77mm	4-Stroke, RS	H-5005
CBR-1000RR 4-Cyl.	2004-07	75mm	4-Stroke	H-5539
CBR-1000RR 4-Cyl.	2008-23	76mm	4-Stroke, AC	H-5708
CBR-1000R, RA	2009-23	76mm	4-Stroke, AC	H-5708
CBR-1000RS 4-Cyl.	2014-19	76mm	4-Stroke, AC	H-5708
RC51 V-Twin 1000	2005-06	100mm	4-Stroke, AC/MO	H-5655
CB-1100F 4-Cyl.	1983-85	70mm	4-Stroke, RS/MO	H-118
CBR-1100XX 4-Cyl.	1997-03	79mm	4-Stroke, CI	H-5332
ST-1100 4-Cyl.	1996-02	73mm	4-Stroke, AC	H-5574
VFR-1200F V-4	2010-14	81mm	4-Stroke, CI	H-5753
VFR-1200X V-4	2016-17	81mm	4-Stroke, CI	H-5753
ST-1300 V-4	2006-18	78mm	4-Stroke, CI	H-5656
VT-1100 Shadow V-Twin	1986-07	87.5mm	4-Stroke, CI	H-961
VTX-1300 V-Twin	2006-20	89.5mm	4-Stroke, CI/MO	H-5657
VTX-1800 V-Twin	2002-08	101mm	4-Stroke, CI	H-5573

HONDA BIG BORE

CB-750 4 Valve to 890	1978-82	67.5mm	4-Stroke, MO	H-113
CB-900 to 985	1979-83	67.5mm	4-Stroke, MO	H-113
CBR-900RR	1996-99	71mm	4-Stroke, CS	H-5331
CB-1100 Big Block 3.100" O.D.	1983-85	74mm	4-Stroke, MO	H-123
VTX-1800 to 1934	2002-08	104.77mm	4-Stroke	H-5573B

KAWASAKI

KE-100	1979-83, 86-01	49.5mm	2-Stroke, AC/MO	KA-786
KE-125	1980-83	56mm	2-Stroke, AC/MO	KA-784
KE-175	1980-82	62.5mm	2-Stroke, AC/MO	KA-785
Eliminator 125	2001-09	55mm	4-Stroke, RS	KA-5658

MODEL	Year	Size (mm)	Type	Part #
KAWASAKI (Continued)				
KZ-200	1977-83	66mm	4-Stroke, RS	KA-673
KLX-230 S/SE	2020-24	67mm	4-Stroke	KA-5825
KR-250	1986-87	56mm	2-stroke, AC	KA-5030
KR1-250	1990-91	56mm	2-Stroke, AC	KA-5142
KZ, KL, KLX-250	1978-83	70mm	4-Stroke, RS	KA-663
KL, KLR-250	1984-05	74mm	4-Stroke, RS	KA-5018
KL-250 Super Sherpa	2000-10	72mm	4-Stroke, AC	KA-5432
KLX-250S/SF	2006-14	72mm	4-Stroke, AC	KA-5637
KLX-250	2018-20	72mm	4-Stroke, AC	KA-5637
Ninja 250R Twin	1986-12	62mm	4-Stroke, RS	KA-970
KLX-300	1997-07	78mm	4-Stroke, AC	KA-5339
KLX-300 R, SM	2020-24	78mm	4-Stroke, AC	KA-5339
KZ-305 Twin	1982-88	61mm	4-Stroke, RS	KA-741
Ninja 400 Twin	2018-23	70mm	4-Stroke, AC	KA-5837
KZ-440 Twin	1980-84	67.5mm	4-Stroke, RS	KA-683
454-LTD Vulcan Twin	1985-88	72.5mm	4-Stroke, RS	KA-863
EX-500 Vulcan Twin	1987-02			
500LTD	2003-09	74mm	4-Stroke, RS	KA-5045
Ninja 500R Twin	1996-09	74mm	4-Stroke, RS	KA-5045
KZ-550, GPZ 4-Cyl.	1980-85			
Zephyr	1991-96	58mm	4-Stroke, RS	KA-685
KLR-600 Single	1984-87	96mm	4-Stroke, RS/MO	KA-861
Eliminator 600	1995-97	60mm	4-Stroke, RS	KA-899
Ninja 600R	1985-97	60mm	4-Stroke, RS	KA-899
ZL 600	1986-88	60mm	4-Stroke, RS	KA-899
Ninja ZX-6	1991-02			
ZZR-600	2003-04	64mm	4-Stroke, RS	KA-5129
Ninja ZX-6R (Flange Depth .200")	1995-99	66mm	4-Stroke, RS	KA-5272
Ninja ZX-6R (Flange Depth .280")	1995-99	66mm	4-Stroke, RS	KA-5577
Ninja ZX-6R	2000-02			
ZZR-600	2005-07	66mm	4-Stroke, AC	KA-5602
Ninja ZX-6R	2003-06	68mm	4-Stroke, AC	KA-5518
Ninja ZX-6RR	2003-06	67mm	4-Stroke, AC	KA-5519
Ninja ZX-6R	2007-12	67mm	4-Stroke, AC	KA-5519
Ninja ZX-6R 636cc	2013-24	67mm	4-Stroke, AC	KA-5755
Ninja 650R Twin	2006-24	83mm	4-Stroke, AC	KA-5659
ER-6N 650 Twin	2009-10	83mm	4-Stroke, AC	KA-5659
Versys 650 Twin	2008-24	83mm	4-Stroke, AC	KA-5659
Vulcan S 650 Twin	2016-24	83mm	4-Stroke, AC	KA-5659
Z650 Twin	2018-24	83mm	4-Stroke, AC	KA-5659
KL, KLR-650 Single	1987-95	100mm	4-Stroke, RS	KA-5009
KLR-650 Single	1996-18	100mm	4-Stroke, RS	KA-5598
KLR-650 Single	2022-24	100mm	4-Stroke	KA-5838
KLX-650R Single	1993-97	100mm	4-Stroke, AC	KA-5226
KLX-650 Single	1993-96	100mm	4-Stroke, RS/MO	KA-5687
KZ-650 Four	1976-83	62mm	4-Stroke, RS/MO	KA-625
W650 Retro Twin	2000-02	72mm	4-Stroke, AC/MO	KA-5464
KZ, ZX, LTD-700		64mm	4-Stroke, RS/L	KA-862
Vulcan 700 Twin	1985	82mm	4-Stroke, RS/MO	KA-928
KZ-750E, GP-750	1980-83	66mm	4-Stroke, RS/MO	KA-686
GPZ-750, ZX-750	1983-85	66mm	4-Stroke, RS/MO	KA-686
ZR-7	2000			
ZR-7S	2001-03	66mm	4-Stroke, RS/MO	KA-686
Vulcan 750 Twin	1986-06	84.9mm	4-Stroke, RS/MO	KA-971
Ninja ZX-750	1987-91	68mm	4-Stroke, RS	KA-5010
Ninja ZX-7	1991-95	71mm	4-Stroke, RS	KA-5189
Ninja ZX-7R	2000-03	73mm	4-Stroke, RS	KA-5335
W800 Twin	2019-24	77mm	4-Stroke	KA-5839
Vulcan 800 Twin	1995-06	88mm	4-Stroke, RS/MO	KA-5275
Vulcan 900 V-Twin	2006-24	88mm	4-Stroke, AC	KA-5660
Ninja GPZ-900R	1984-86	72.5mm	4-Stroke, RS	KA-863
ZL-900 A1, A2	1985-86	72.5mm	4-Stroke, RS	KA-863
Ninja ZX-9R	1994-97	73mm	4-Stroke, RS/MO	KA-5254
Ninja ZX-9R	2000-03	75mm	4-Stroke, AC	KA-5380

MODEL	Year	Size (mm)	Type	Part #
KAWASAKI (Continued)				
Z900 948cc 4-Cyl.	2017-24	73.4mm	4-Stroke, AC	KA-5840
KZ-1000	1976-80	70mm	4-Stroke, RS	KA-627
KZ-1000	1981-83	69.4mm	4-Stroke, RS/MO	KA-743
Ninja ZG, ZL, ZX-1000A	1986-83	74mm	4-Stroke, RS	KA-5045
Concours	1995-05	74mm	4-Stroke, RS	KA-5045
Ninja ZX-10 1000B	1988-90	74mm	4-Stroke, RS/L	KA-972
Z1000	2003-08	77.2mm	4-Stroke, AC	KA-5520
ZX-10R	2004-07	76mm	4-Stroke, AC	KA-5542
Ninja ZX-10R 998c	2008-15	76mm	4-Stroke, AC	KA-5709
Ninja ZX-10R 998c	2016-24	76mm	4-Stroke, AC	KA-5709
Ninja Z1000 1043cc 4-Cyl.	2011-19	77mm	4-Stroke, AC	KA-5756
Ninja 1000SX 1043cc 4-Cyl.	2020-24	77mm	4-Stroke, AC	KA-5756
Ninja ZX-11	1990-01	76mm	4-Stroke, RS/MO	KA-5081
ZRX-1100	1998-00	76mm	4-Stroke, RS/MO	KA-5081
GPZ, ZX, LTD-1100	1981-85	72.5mm	4-Stroke, RS	KA-744
GPZ-1100	1995-96	76mm	4-Stroke, RS/MO	KA-5081
ZR-1100	1993-94	73.5mm	4-Stroke, RS/L	KA-5210
ZRX-1200R	2001-05	79mm	4-Stroke, AC/MO	KA-5456
ZZR-1200	2003-05	79mm	4-Stroke, AC/MO	KA-5456
ZG-1200 Voyager XII	1987-03	78mm	4-Stroke, RS/MO	KA-5046
Ninja ZX-12R	2000-05	83mm	4-Stroke, AC	KA-5433
Ninja ZX-14 4 Cyl.	2006-11	84mm	4-Stroke, AC	KA-5661
Ninja ZX-14R 4-Cyl. Use for sleeving one cylinder Set of 4 (2 center, 2 end sleeves) Flanged sleeves w/ siamese flats Use for sleeving all 4 cylinders	2012-24	84mm	4-Stroke, AC	KA-5757K4
Concours 14 4-Cyl. Use for sleeving one cylinder Set of 4 (2 center, 2 end sleeves) Flanged sleeves w/ siamese flats Use for sleeving all 4 cylinders	2008-22	84mm	4-Stroke, AC	KA-5661K4
KZ-1300 6-Cyl.	1979-88	62mm	4-Stroke, RS/MO	KA-664
Vulcan VN-1500 V-Twin	1987-08	102mm	4-Stroke, RS/MO	KA-5047
Big Bore to 1600cc		105mm	4-Stroke, RS/MO	KA-5047B
Vulcan 1600 V-Twin 95 C.I.	2003-08	102mm	4-Stroke, RS/MO	KA-5662
Vulcan 1700 V-Twin 104 C.I.	2009-24	102mm	4-Stroke, RS	KA-5710
Vulcan 2000 V-Twin 125 C.I.	2004-09	103mm	4-Stroke, AC/MO	KA-5663
KAWASAKI BIG BORE				
B = Outside Diameter C = Flange (Lip) Diameter D = Flange Thickness E = Overall Length F = Bottom Skirt O.D.				
ZX, KZ, GPZ-550		58mm	4-Cyl /MO	KA-685
ZN, KZ, GPZ-750	1980-83	66mm	4-Cyl /MO	KA-686
ZX-750-E1, Turbo	1983-85	66mm	4-Cyl /MO	KA-686
GPZ-900R Ninja				
Eliminator 4-Valve	thru 1986	72.5mm	4-Cyl / MO	KA-863
KZ-900, KZ-1000				
B=3.200/C=3.415/D=.165/ E=4.540/F=3.185		72mm	4-Cyl /MO	KA-629
B=3.200/C=3.415/D=.250/E=4.560		72mm	4-Cyl /MO	KA-629-1
B=3.200/C=3.415/D=.255/E=4.560		72mm	4-Cyl /MO	KA-629-2
KZ-900, KZ-1000 Big Block				
B=3.350/C=3.600/D=.255/E=4.550		75mm	4-Cyl /MO	KA-3350
B=3.275/C=3.500/D=.200/E=4.540		76mm	4-Cyl /MO	KA-750
B=3.275/C=3.500/D=.250/E=4.550		76mm	4-Cyl /MO	KA-750-1
B=3.275/C=3.500/D=.255/E=4.540		76mm	4-Cyl /MO	KA-750-2
B=3.450/C=3.600/D=.200/E=4.540		76mm	4-Cyl /MO	KA-774
B=3.450/C=3.600/D=.200/E=4.560		80mm	4-Cyl /MO	KA-773
B=3.450/C=3.600/D=.250/E=4.580		80mm	4-Cyl /MO	KA-773-2
B=3.450/C=3.600/D=.255/E=4.575		80mm	4-Cyl /MO	KA-773-3
B=3.460/C=3.700/D=.250/E=4.575		80mm	4-Cyl /MO	KA-775
GPZ-1100	1981-82			
B=3.200/C=3.415/D=.165/ E=4.540/F=3.185		72-75mm	4-Cyl /MO	KA-629
B=3.200/C=3.415/D=.255/E=4.560		72-75mm	4-Cyl /MO	KA-629-2

MODEL	Year	Size (mm)	Type	Part #
KAWASAKI (Continued)				
GPZ-1100	1981-82			
B=3.275/C=3.500/D=.200/E=4.540		76-80mm	4-Cyl /MO	KA-750
B=3.275/C=3.500/D=.255/E=4.540		76-80mm	4-Cyl /MO	KA-750-2
ZX, LTD, GPZ-1100	1983-84			
B=3.200/C=3.415/D=.165/ E=4.540/F=3.185		72-75mm	4-Cyl /MO	KA-629
B=3.200/C=3.415/D=.255/E=4.560		72-75mm	4-Cyl /MO	KA-629-2
GPZ, KZ Big Block 1497cc				
B=3.550/C=3.700/D=.200/E=4.625		85mm	4-Cyl /MO	SU-3550
KTM				
KTM400, LC4, SXC	2000-02	89mm	4-Stroke, AC	FL-5436
KTM 620 LC4 E/XC	1994-98	101mm	4-Stroke, AC	FL-5243
KTM 640 LC4	1999-07	101mm	4-Stroke, AC	FL-5396
690 Duke, Enduro	2008-17	102mm	4-Stroke, AC	FL-5716
690 Duke, Enduro R	2018-24	105mm	4-Stroke, AC	FL-5808
790 Duke, Adventure R LC8c Twin	2018-24	88mm	4-Stroke, AC	FL-5841
1090 Adventure R V-Twin	2017-19	103mm	4-Stroke, AC	FL-5842
1290 Duke, Adventure R V-Twin	2014-24	108mm	4-Stroke, AC	FL-5843
LAVERDA				
1000 Triple	1974-82	75mm	4-Stroke, RS/MO	FL-645
1200 Triple		80mm	4-Stroke, RS/MO	FL-5261
MOTO-GUZZI				
750 & 850 Ambassador VT		83mm	4-Stroke, AC/MO	FL-183
Big Bore Conversion for 750 & 850		88mm	AC/MO	FL-369
Le Mans 1000	1986-88	88mm	4-Stroke, AC/MO	FL-369
750 V-Twin	2004-21	80mm	4-Stroke, AC	FL-5664
1100 V-Twin	1995-07	92mm	4-Stroke, AC	FL-5279
1200 V-Twin	2005-21	95mm	4-Stroke, AC	FL-5665
SUZUKI				
DR, SP-100	1983-89	51mm	4-Stroke, CS	FL-802
GN, SP, DR-125	1982-97	57mm	4-Stroke, CI	FL-753
TS-125R (European)	1989-95	56mm	2-Stroke, CI/MO	FL-7015
DR, SP-200	1986-04	66mm	4-Stroke, CI	FL-975
DR-200SE, DR-200S	2005-22	66mm	4-Stroke, CI	FL-975
GS-250T	1980-82	60mm	4-Stroke, RS/L	FL-688
GN, DR, SP-250	1982-88	72mm	4-Stroke, RS/MO	FL-754
DR 250S	1990-95	73mm	4-Stroke, CI	FL-5130
GZ-250	1999-09	72mm	4-Stroke, RS	FL-5398
RG-250 Gamma	1984-85	54mm	2-Stroke, CS/L	FL-870
RGV-250 (Euro-Australia)	1989	56mm	2-Stroke, AC/MO	FL-7010
RGV-250 (Euro-Australia)	1990	56mm	2-Stroke, AC/MO	FL-7011
TU-250X	2009-19	72mm	4-Stroke, AC	FL-5758
DR-350	1990-99	79mm	4-Stroke, CI	FL-5112
DR-350 Heavy O.D. allows bore size to 83mm	1990-99	79-83mm	4-Stroke, CS	FL-5112H
DR-2400, E, S	2000-24	90mm	4-Stroke, AC	FL-5430
DR, SP-400	1980-82	88mm	4-Stroke, RS/MO	FL-690
GSF-400 Four	1990-94	56mm	4-Stroke, RS/L	FL-5131
GS-450	1980-88	71mm	4-Stroke, RS/L	FL-691
GS-500 Twin	1989-09	74mm	4-Stroke, RS/MO	FL-5099
RG-500 Gamma	1986-87	56mm	2-Stroke, CI/L	FL-5031
GS-550	1977-82	56mm	4-Stroke, RS/L	FL-636
GS-550 Katana	1983-86	60mm	4-Stroke, RS/L	FL-806
GSX-600 F Katana	1988-06	62.6mm	4-Stroke, RS	FL-5050
GSF-600 S Bandit	1996-03	62.6mm	4-Stroke, RS	FL-5050
	1992-93	65mm	4-Stroke, RS	FL-5218
GSX-R600	1997-00	65.5mm	4-Stroke, AC	FL-5333
	2001-05	67mm	4-Stroke, AC	FL-5459
	2006-24	67mm	4-Stroke, AC	FL-5818
GF-600R	1994-96	65mm	4-Stroke, RS	FL-5218

STREET BIKE SLEEVES



MODEL	Year	Size (mm)	Type	Part #
SUZUKI (Continued)				
SP-600	1985	94mm	4-Stroke, RS/MO	FL-871
DR-650SE	1993-95	95mm	4-Stroke, RS	FL-5219
DR-650SE, S	1996-24	100mm	4-Stroke, AC	FL-5309
Gladius 650 Twin	2009	81mm	4-Stroke, AC	FL-5421
SV-650 V-Twin	1999-24	81mm	4-Stroke, AC	FL-5421
V-STROM 650 V-Twin	2004-24	81mm	4-Stroke, AC	FL-5421
SV-650 Big Bore	1999-24			
V-STROM 650 Big Bore	2004-24	87-90mm	4-Stroke, CS	FL-5421B
GSX-650F 4-Cyl.	2008-09	65.50mm	4-Stroke, AC/MO	FL-5711
GS-650, XN-85 Four	1982-85	62mm	4-Stroke, RS	FL-757
GR-650	1983	77mm	4-Stroke, RS/L	FL-807
GS-700E	1984-85	67mm	4-Stroke, RS/MO	FL-867
GS-750	1980-82	67mm	4-Stroke, RS/MO	FL-714
GS-750 X Katana	1983	67mm	4-Stroke, RS/L	FL-808
GSX-750 F Katana	1992-97	73mm	4-Stroke, RS	FL-5051
	1998-06	70mm	4-Stroke, MO	FL-5383
	1986-87	70mm	4-Stroke, RS/MO	FL-946
	1988-89	73mm	4-Stroke, RS	FL-5051
GSX-R750 4-Cyl.	1990-92	70mm	4-Stroke, RS	FL-5132
	1993-95	70mm	4-Stroke, RS	FL-5170
	1996-05	72mm	4-Stroke, AC	FL-5289
	2006-24	70mm	4-Stroke, AC	FL-5643
GSX-S750,Z 4-Cyl.	2016-23	72mm	4-Stroke, AC	FL-5289
GS-850	1978-83	69mm	4-Stroke, RS/MO	FL-668
RF-900R	1994-97	73mm	4-Stroke, RS/L	FL-5227
GS-1000	1978-82	70mm	4-Stroke, RS/MO	FL-654
GS-1000 Katana	1982-83	69.4mm	4-Stroke, RS	FL-759
SV-1000 V-Twin	2003-07	98mm	4-Stroke, AC	FL-5460
TL-1000R, S	1997-03	98mm	4-Stroke, AC	FL-5460
V-STROM 1000 V-Twin	2003-12	98mm	4-Stroke, AC	FL-5460
V-STROM 1000 V-Twin	2014-19	100mm	4-Stroke, AC	FL-5844
V-STROM 1050 V-Twin	2020-24	100mm	4-Stroke, AC	FL-5844
GSX-R1000 4-Cyl.	2001-04	73mm	4-Stroke, AC/MO	FL-5461
GSX-R1000 4-Cyl.	2005-08	73.4mm	4-Stroke, AC	FL-5644
GSX-R1000 4-Cyl.	2009-16	74.5mm	4-Stroke, AC	FL-5712
GSX-R1000 4-Cyl.	2017-24	76mm	4-Stroke, AC	FL-5821
GSX-S1000 4-Cyl.	2016-24	73.4mm	4-Stroke, AC	FL-5644
GS-1100	1979-82	72mm	4-Stroke, RS/MO	FL-692
GSX-R1100	1986-88	76mm	4-Stroke, RS/MO	FL-954
	1988-93	78mm	4-Stroke, RS	
GSX-1100 F, G Katana			(3 req.)	FL-5052
	Clearance	Notched	(1 req.)	FL-5052N
GSX-R1100	1989-92	78mm	4-Stroke, RS/MO	FL-5110
	1993-98	75.5mm	4-Stroke, RS/MO	FL-5220
GS-1150	1984-86	74mm	4-Stroke, RS/MO	FL-872
GSF-1200 S Bandit	1996-09	79mm	4-Stroke, RS	FL-5334
Bandit 1250, GSX-1250FA 4-Cyl.	2007-16	79mm	4-Stroke, RS	FL-5645
GSX-1300 R Hayabusa	1999-07	81mm	4-Stroke, AC	FL-5399
GSX-1300 R Hayabusa	1999-07	81-84mm	4-Stroke, AC	FL-5399
Set of 4 (2 center, 2 end sleeves)				CDX4
Flanged Closed Deck Ductile Iron				
Hayabusa 1340	2008-24	81mm	4-Stroke, AC	FL-5713
Hayabusa 1340	2008-24	81-84mm	4-Stroke, AC	FL-5713
Set of 4 (2 center, 2 end sleeves)				CDX4
Flanged Closed Deck Ductile Iron				
Boulevard S40 40 C.I.	2005-19	94mm	4-Stroke, CI	FL-5646
Boulevard C50, M50, S50 V-Twin 50 C.I.	2005-24	83mm	4-Stroke, CI	FL-5647
Boulevard S83 V-Twin 83 C.I.	2005-09	94mm	4-Stroke, AC	FL-5648
Boulevard C90 V-Twin 90 C.I.	2005-22	96mm	4-Stroke, AC	FL-5649
Boulevard M109R V-Twin 109 C.I.	2006-23	112mm	4-Stroke, AC	FL-5650

MODEL	Year	Size (mm)	Type	Part #
SUZUKI BIG BORE				
<i>B = Outside Diameter C = Flange (Lip) Diameter D = Flange Thickness E = Overall Length F = Bottom Skirt O.D.</i>				
GS-750	1980-82	67mm	4-Cyl /MO	FL-714
GSXR-750				
B=3.150/C=3.295/D=.240/ E=3.915/F=3.135	1986-87	73mm	4-Cyl /MO	FL-947
B=3.190/C=3.390/D=.240/E=3.915	1990-95	73mm	4-Cyl /MO	FL-5175
B=3.150/C=3.425/D=1.615/E=3.915	1993-95	76mm	4-Cyl /MO	FL-5285
GSX-R1100	1986-88	76mm	4-Cyl /MO	FL-954
B=3.450/C=3.650/D=.250/E=4.400	1986-88	80-83mm	4-Cyl /MO	FL-5117
B=3.450/C=3.600/D=.250/E=4.575	1986-88	80-83mm	4-Cyl /MO	KA-773-2
B=3.450/C=3.600/D=.255/E=4.575	1986-88	80-83mm	4-Cyl /MO	KA-773-3
GSX-R1100 Big Block				
B=3.550/C=3.700/D=.250/E=4.600	1979-92	83-85mm	4-Cyl /MO	SU-3552
B=3.450/C=3.650/D=.255/E=4.400	1989-92	80-83mm	4-Cyl /MO	FL-5117
B=3.550/C=3.700/D=.250/E=4.620	1979-92	83-85mm	4-Cyl /MO	SU-3551
B=3.550/C=3.700/D=.200/E=4.625	1979-92	84-85mm	4-Cyl /MO	SU-3550
B=3.550/C=3.700/D=.255/E=4.300	1989-92	85mm	4-Cyl /MO	SU-3553
GSX-R1100 Big Block				
B=3.275/C=3.500/D=.250/E=4.575	1979-82	75mm	4-Cyl /MO	KA-750-5
B=3.275/C=3.500/D=.200/E=4.575	1979-82	76-80mm	4-Cyl /MO	KA-750
B=3.275/C=3.500/D=.250/E=4.550	1979-82	76-80mm	4-Cyl /MO	KA-750-1
B=3.275/C=3.500/D=.255/E=4.580	1979-82	76-80mm	4-Cyl /MO	KA-750-2
B=3.450/C=3.600/D=.200/E=4.575	1979-82	80mm	4-Cyl /MO	KA-773
B=3.450/C=3.600/D=.250/E=4.575	1979-82	80mm	4-Cyl /MO	KA-773-2
B=3.450/C=3.600/D=.255/E=4.575	1979-82	80mm	4-Cyl /MO	KA-773-3
B=3.460/C=3.700/D=.250/E=4.575	1979-82	80mm	4-Cyl /MO	KA-775
B=3.600/C=3.700/D=.250/E=4.625	1979-82	83-85mm	4-Cyl /MO	SU-3600
B=3.650/C=3.700/D=.250/E=4.575	1979-82	87mm	4-Cyl /MO	OE-3650
GSXR-1100	1993-98	79.5mm	4-Cyl /MO	FL-5338
GS-1150 Big Block				
B=3.275/C=3.500/D=.200/E=4.575	thru 1986	76-80mm	4-Cyl /MO	KA-750
B=3.275/C=3.500/D=.250/E=4.550	thru 1986	76-80mm	4-Cyl /MO	KA-750-1
B=3.275/C=3.500/D=.255/E=4.540	thru 1986	76-80mm	4-Cyl /MO	KA-750-2
B=3.350/C=3.600/D=.255/E=4.550	thru 1986	76mm	4-Cyl /MO	SU-3350-1
B=3.450/C=3.600/D=.200/E=4.575	thru 1986	80mm	4-Cyl /MO	KA-773
B=3.450/C=3.600/D=.250/E=4.575	thru 1986	80mm	4-Cyl /MO	KA-773-2
B=3.450/C=3.600/D=.255/E=4.575	thru 1986	80mm	4-Cyl /MO	KA-773-3
B=3.550/C=3.700/D=.250/E=4.625	thru 1986	83-85mm	4-Cyl /MO	SU-3551
B=3.550/C=3.700/D=.255/E=4.600	thru 1986	83-85mm	4-Cyl /MO	SU-3552
B=3.550/C=3.700/D=.200/E=4.625	thru 1986	84-85mm	4-Cyl /MO	SU-3550
B=3.600/C=3.700/D=.250/E=4.625	thru 1986	83-85mm	4-Cyl /MO	SU-3600
B=3.600/C=3.700/D=.255/E=4.600	thru 1986	83-85mm	4-Cyl /MO	SU-3600-1
B=3.650/C=3.700/D=.250/E=4.575		87mm	4-Cyl /MO	OE-3650

TRIUMPH

LASCO flanged replacement sleeves are +.003 O.D. larger than factory Triumph stock sleeves.

675 Triple Liquid-Cooled	2006-09	74mm	4-Stroke	FL-5651
800 Twin	2001-05	86mm	4-Stroke	FL-5480
865 Twin	2005-14	90mm	4-Stroke	FL-5652
885 Triple Liquid-Cooled	1998-04	76mm	4-Stroke	FL-5446
950i Triple Liquid Cooled				
Finished Hone Bore	1990-01	79mm	4-Stroke, RS	FL-5703
1200 Trophy 4-Cyl.	1999-03	76mm	4-Stroke, RS	FL-5446

VESPA

Vespa 250		66.5mm	2-Stroke, AC/L	FL-5188
-----------	--	--------	----------------	---------

YAMAHA

YSR-50	All Years	40-44mm	2-Stroke, CC/L	YA-5269
DT-125LC, RD-125LC	1982-83	56mm	2-Stroke, CI/MO	YA-7021
DT-125LC YPVS, RD-125LC YPVS	1984-90	56mm	2-Stroke, CI/MO	YA-7020
DT-125R (No. 1KT European)	1987-92	56mm	2-Stroke, CI/MO	YA-7001
DT-125 (No. 3BN European)	1988	56mm	2-Stroke, CS/MO	YA-7005
DTR-125 (No. 3MB European)	1989-94	56mm	2-Stroke, CS/MO	YA-7014



STREET BIKE SLEEVES

MODEL	Year	Size (mm)	Type	Part #
YAMAHA (Continued)				
DTR-125	1994-95	56mm	2-Stroke, AC/MO	YA-7014
TZR-125 (No. 2RH, 2RL, 4GM)	1987-92	56.4mm	2-Stroke, CI/MO	YA-7001
TZR-125 (No. 4FL)	1993-95	56mm	2-Stroke, AC/MO	YA-7014
TZR-125 (No. 4FU)		56mm	2-Stroke, AC/MO	YA-7041
XT-125	1982-84	57mm	4-Stroke, RS/MO	YA-761
SDR-200 YVPS (No. 2TV)	1988-89	66mm	2-Stroke, CI/L	YA-5070
Big Bore to 240cc (Head Mod. Req.)		72mm	CS/L	YA-5070B
TW-200	1987-24	67mm	4-Stroke, RS	YA-762
XT-200	1982-87	67mm	4-Stroke, RS	YA-762
XT-225	1983-00	70mm	4-Stroke, RS	YA-812
XT-225	2001-07	70mm	4-Stroke, AC	YA-5631
XT, SR-250	1980-83	75mm	4-Stroke, RS/MO	YA-697
XT-250	1984-85	73mm	4-Stroke, RS/MO	YA-880
XT-250	2008-24	74mm	4-Stroke, AC	YA-5702
WR-250R/X (No. 37D)	2008-20	77mm	4-Stroke, AC	YA-5701
Virago 250 V-Twin	1995-07	49mm	4-Stroke, CI	YA-5760
V-Star 250 V-Twin (No. 3BG)	2008-24	49mm	4-Stroke, CI	YA-5760
RZ-350 (No. 48H)	1984-85	64mm	2-Stroke, CI	YA-881
XT-350	1985-00	86mm	4-Stroke, RS	YA-902
FZR-400 Four	1988-89	56mm	4-Stroke, RS	YA-5057
XS-400	1979-83	69mm	4-Stroke, RS/MO	YA-670
XT, TT-500C	1975-82	87mm	4-Stroke, RS	YA-375
Big Bore to 535cc		90mm		YA-375B
SR-500 (European 1980-86)	1978-82	87mm	4-Stroke, RS	YA-375
Virago 500	1983-85	73mm	4-Stroke, RS/L	YA-815
			2-Stroke, CS	
RZV-500	1984-87	56mm	2 rear cyls	YA-883R
			2 front cyls	YA-884F
Virago V-535	1987-00	76mm	4-Stroke, RS	YA-5026
XT-550	1982-83	92mm	4-Stroke, RS/MO	YA-768
550 Vision	1982-85	80mm	4-Stroke, RS	YA-769
550 Seca, Maxim Four	1981-83	57mm	4-Stroke, RS/MO	YA-770
SRX-600	1985-95	95mm	4-Stroke, AC	YA-814
Big Bore to 620cc		98mm		YA-814BB
Big Bore to 640cc		101mm		YA-7028
FZ, YX, FJ, XJ-600, Seca II	1984-97	58.5mm	4-Stroke, RS/MO	YA-885
FZR-600	1989-99	59mm	4-Stroke, RS/L	YA-5096
YZF-600R	1994-07	62mm	4-Stroke, RS/MO	YA-5259
YZF-R6	1999-05	65.5mm	4-Stroke, AC	YA-5401
YZF-R6S	2003-09	65.5mm	4-Stroke, AC	YA-5401
FZ6	2004-09	65.5mm	4-Stroke, AC	YA-5401
FZ6R	2009-17	65.5mm	4-Stroke, AC	YA-5401
YZF-R6 Center Sleeve	2006-20	67mm	4-Stroke, AC	YA-5667C
YZF-R6 End Sleeve	2006-20	67mm	4-Stroke, AC	YA-5667E
XS-650 Twin	1972-85	75mm	4-Stroke, RS	YA-128
Big Bore to 750cc		80mm		YA-132
XJ-650	1980-85	63mm	4-Stroke, RS/MO	YA-699
XJ-650 Turbo	1982-83	63mm	4-Stroke, RS/MO	YA-5720
V-Star 650 V-Twin 40 C.I.	1999-16	81mm	4-Stroke, RS	YA-5427
SZR-660	1996	100mm	4-Stroke, RS	YA-7018
XTZ-660	1991-96	100mm	4-Stroke, RS	YA-7018
FZ-700 Maxim, Fazer	1985-87	68mm	4-Stroke, RS/L	YA-891
XJ-700 Maxim	1986	68mm	4-Stroke, RS/L	YA-982
XV-700 Virago	1984-87	80mm	4-Stroke, RS/MO	YA-890
FZ07 Twin 689cc	2015-17	80mm	4-Stroke, AC	YA-5846
MT-07 Twin 689cc	2018-24	80mm	4-Stroke, AC	YA-5846
Tenere 700 Twin 689cc	2021-24	80mm	4-Stroke, AC	YA-5846
XSR-700 Twin 689cc	2017-24	80mm	4-Stroke, AC	YA-5846
YZF-R7 Twin 689cc	2022-24	80mm	4-Stroke, AC	YA-5846
FZ-750, FZR	1986-89	68mm	4-Stroke, RS/L	YA-953
TX-750 Twin		80mm	4-Stroke, RS/MO	YA-351
XJ-750 Seca	1980-85	65mm	4-Stroke, RS/MO	YA-771
XV-750 Virago Twin	1981-97	83mm	4-Stroke, RS/MO	YA-725
OWOI-750	1990-92	72mm	4-Stroke, RS	YA-5115
YZF-750R	1989-97	72mm	4-Stroke, RS	YA-5115

MODEL	Year	Size (mm)	Type	Part #
YAMAHA (Continued)				
FZ8 4-Cyl Liquid-Cooled	2012-13	68mm	4-Stroke, AC	YA-5761
XS-850 3-Cyl.	1980-83	71.5mm	4-Stroke, RS/MO	YA-671
TDM-850 Twin	1989-96	89.5mm	4-Stroke, MO	YA-5224
FJ09 Triple 847cc Liquid-Cooled	2015-17	78mm	4-Stroke, AC	YA-5847
FZ09 Triple 847cc Liquid-Cooled	2014-17	78mm	4-Stroke, AC	YA-5847
MT09 Triple 847cc Liquid-Cooled	2018-20	78mm	4-Stroke, AC	YA-5847
MT09 Triple 890cc Liquid-Cooled	2021-24	78mm	4-Stroke, AC	YA-5848
Niken GT Triple 847cc Liq. Cooled	2019	78mm	4-Stroke, AC	YA-5847
Tracer 900 GT Triple 847cc	2019-20	78mm	4-Stroke, AC	YA-5847
Tracer 900 GT Triple 890cc	2021-24	78mm	4-Stroke, AC	YA-5848
XSR-900 Triple 847cc Liquid-Cooled	2016-21	78mm	4-Stroke, AC	YA-5847
XSR-900 Triple 890cc Liquid-Cooled	2022-24	78mm	4-Stroke, AC	YA-5848
XJ-900 Seca	1983-84	67mm	4-Stroke, RS/MO	YA-816
XV-920 Virago Twin	1981-83	92mm	4-Stroke, RS/MO	YA-772
V-Star 950 V-Twin	2009-17	85mm	4-Stroke, AC	YA-5762
Bolt 950 V-Twin	2014-24	85mm	4-Stroke, AC	YA-5762
FZR-1000	1987-88	75mm	4-Stroke, RS/MO	YA-5027
	1989-95	75.5mm	4-Stroke, RS/MO	YA-5083
FZ1	2001-05	74mm	4-Stroke, AC	YA-5501
FZ1, FZS-1000	2006-07	77mm	4-Stroke, AC	YA-5540
FZ10 4-Cyl. 998cc	2017	79mm	4-Stroke, AC	YA-5849
GTS-1000	1994-95	75.5mm	4-Stroke, RS	YA-5083
MT10 4-Cyl. 998cc	2018-24	79mm	4-Stroke, AC	YA-5849
YZF-1000R	1997	75.5mm	4-Stroke RS	YA-5083
YZF-R1	1998-03	74mm	4-Stroke, AC	YA-5501
YZF-R1	2004-08	77mm	4-Stroke, AC	YA-5540
YZF-R1	2009-14	78mm	4-Stroke, AC	YA-5715
YZF-R1	2015-24	79mm	4-Stroke, AC	YA-5849
XV1100 Virago Twin	1986-99	95mm	4-Stroke, RS	YA-983
XVS-1100 V-Star, V-Twin 65 C.I.	1999-09	95mm	4-Stroke, AC	YA-5759
XS-1100 4-Cyl.	1979-83	71.5mm	4-Stroke, RS/MO	YA-671
FJ-1100	1984-85	74mm	4-Stroke, RS/MO	YA-887
FJ-1200	1986-93	77mm	4-Stroke, RS/L	YA-984
Venture 1200 V-4	1983-85	76mm	4-Stroke, RS	YA-817
V-Max 1200 V-4	1985-07	76mm	4-Stroke, RS	YA-817
Super Tenere 1200 Twin	2012-23	98mm	4-Stroke, AC	YA-5763
Stryker 1300 V-Twin 80 C.I.	2012-17	100mm	4-Stroke, AC	YA-5764
V-Star 1300 V-Twin 80 C.I.	2007-17	100mm	4-Stroke, AC	YA-5764
XV-1300 Venture, Royal Star V-4	1986-13	79mm	4-Stroke, RS	YA-5017
FJR-1300 In-Line 4-Cyl.	2003-24	79mm	4-Stroke, AC	YA-5541
Roadstar 1600 V-Twin	1993-04	95mm	4-Stroke, AC	YA-5428
Big Bore to 1775cc		100mm	MO	YA-5428B
Roadstar 1700 V-Twin 102 C.I.	2002-14	97mm	4-Stroke, AC	YA-5668
Warrior 1700	2002-14	97mm	4-Stroke, AC	YA-5668
Roadstar 1850 V-Twin 113 C.I.	2006-07	100mm	4-Stroke, AC	YA-5669
Stratoliner 1850, Raider, Star Venture				

YAMAHA BIG BORE

B = Outside Diameter C = Flange (Lip) Diameter D = Flange Thickness E = Overall Length
F = Bottom Skirt O.D.

XS-650				
B=3.400/C=3.620/D=.205/ E=5.530/F=3.350	1972-85	80mm	Twin	YA-132
FZR-1000				
B=3.250/C=3.405/D=.195/E=3.812	1989-97	78mm	4-Cyl / MO	YA-5067
FJ-1100 4-Valve	1984-85			
FJ-1200 4-Valve	1986-93			
B=3.232/C=3.540/D=.200/ E=4.370/F=3.206		77mm	4-Cyl / MO	YA-984
FJ-1100, FJ-1200				
B=3.390/C=3.540/D=.200/ E=4.365		79mm	4-Cyl / MO	YA-991
FJ-1100, FJ-1200				
B=3.550/C=3.650/D=.200/ E=4.365		83mm	4-Cyl / MO	YA-5029



ATV • UTV





MODEL
Engine Description
Cylinder I.D. (mm/in.)



SLEEVE

REBUILD KIT
Sleeve - Piston
Gasket - T.E. Bearing

BORE SIZE (mm)

PISTON SIZE

TOP END

TOP END

VALVE TRAIN

BOTTOM END

PRO-X PISTON

LAPC PISTON

WISECO PISTON

WOSSNER PISTON

VERTEX PISTON

JE PISTON

COMETIC GASKET

L.A. SLEEVE GASKET

CYLINDER AFTERMARKET KITS

VALVE / SPRING KIT

VALVE GUIDE

CAMSHAFT

CAM CHAIN

CRANKSHAFT

CON-ROD KIT

CRANK BEARING

ENGINE OIL SEAL KIT

ARCTIC-CAT ATV-UTV FOUR-STROKE

MODEL	CI	FL	BORE	STROKE	PRO-X PISTON	LAPC PISTON	WISECO PISTON	WOSSNER PISTON	VERTEX PISTON	JE PISTON	COMETIC GASKET	L.A. SLEEVE GASKET	CYLINDER AFTERMARKET KITS	VALVE / SPRING KIT	VALVE GUIDE	CAMSHAFT	CAM CHAIN	CRANKSHAFT	CON-ROD KIT	CRANK BEARING	ENGINE OIL SEAL KIT	
90 DVX, AUTO Alterra 2006-24 90cc 47mm 1.850"		FL-5615																				
150 DVX 2009-19 149cc 62mm 2.440"		FL-5409																				
250 4x4, 2x4 2009-05 246cc 66mm 2.598"	CI	FL-5019	66.00 66.50 67.00 67.50 68.00	Std. .020 .040 .060 .080			9.2:1 Comp. 2720 2722 2724						Top End 35-0827 Complete w/oil seals 37-1827									
250 DVX, 2x4 2006-09 249cc 72.7mm 2.862"	AC	FL-5613																				
300 DVX, Alterra 2009-24 270cc 72.7mm 2.862"	AC	FL-5543												Top End (13-24) 35-0013								
300 4x4, 2x4 1998-05 280cc 68.5mm 2.697"	CI	FL-5136	68.50 69.00 69.50	Std. .020 .040			8.5:1 Comp. 2730 2732 2734							Top End 35-0826 Complete w/oil seals 37-1826								
350 4X4 2011-12 366 4x4 2008-11 400 TRV 2009-14 400 CORE 2013-15 400 Alterra 2016-17 366cc 81mm 3.188"	CI	FL-5670	81.00	Std.																		
375 4x4, 2x4 2002 400 4x4, 2x4 2003-08 376cc 82mm 3.228"	CS	FL-5512												Top End 35-0846								
400 4x4, 2x4 1998-02 371cc 84mm 3.307"	CI	FL-5364																				



ATV-UTV
ARCTIC-CAT

ATV-UTV
BOMBARDIER

ATV-UTV
HONDA

ATV-UTV
KAWASAKI

ATV-UTV
KTM/KYMCO

ATV-UTV
POLARIS

ATV-UTV
SUZUKI

ATV-UTV
YAMAHA

PERSONAL
WATERCRAFT



MODEL
Engine Description
Cylinder I.D. (mm/in.)



SLEEVE

REBUILD KIT
Sleeve, Piston
Gasket, T.E. Bearing

BORE SIZE
(mm)

PISTON SIZE

TOP END

TOP END

VALVE TRAIN

BOTTOM END

PRO-X PISTON

LAPC PISTON

WISECO PISTON

WOSSNER PISTON

VERTEX PISTON

JE PISTON

COMETIC GASKET

L.A. SLEEVE GASKET

CYLINDER AFTERMARKET KITS

VALVE / SPRING KIT

VALVE GUIDE

CAMSHAFT

CAM CHAIN

CRANKSHAFT

CON-ROD KIT

CRANK BEARING

ENGINE OIL SEAL KIT

ARCTIC-CAT ATV-UTV FOUR-STROKE (CONTINUED)

MODEL	Year	AC	FL	5430K	90.00	Std.	12.25:1 Comp.	12.25:1 Comp.	12.25:1 Comp.	11.3:1 Comp.	12:1 Comp.	Top End	Top End	Cylinder Works	Intake	Valve Guide	Hot Cams	CC-3403	HR4059	Pro-X	6306RI	
400 DVX 2x4 398cc Liquid Cooled 90mm 3.543"	2004-08	AC	FL-5430	5430K	90.00 90.01 91.00 92.00	Std. Std. .040 .080	5220A 5220B 5224	4713M09000 4713M09200	8563DA 8563DB	VT22951A VT22951B	180297 199657	C7978-EST (92mm)	35-3402 (90mm)	40001 (Std. 90mm)	28-34022 Exhaust 28-34021 Set 28-3402S	IN / EX 60-60060 O/S +.001 60-60061	2249-11N (Intake) 2250-1E (Exhaust)			04921	Bearing / Seal Kit 49K049	
RESLEEVEING REQUIRED FOR OVERSIZES CYLINDER WORKS COMPLETE KIT INCLUDES CYLINDER, PISTON KIT, GASKETS					90.00 92.00	Std. .080		4713M09000 4714M09200	8567DA	VT23550A		Complete w/oil seals 37-3402	Cylinder Works Complete Kit 40001-K01 (Std. 90mm)	28-34022 Exhaust 28-34021 Set 28-3402S	O/S +.001 60-60061					Hot Rods Bottom End Kit CBK0096 Includes Crankshaft, Bearings Seals, Complete Gasket Set		
400 DVX 2x4 Big Bore 434cc to 450cc 94mm 3.700"	2004-08	BB	FL-5430B		94.00 94.50 95.00 95.50	.160 .180 .200 .220		4795M09450	8563D400	VT23533	183051 243651	C7979-EST (94mm)		41001-K01 (434cc, 94mm)	28-34022 Exhaust 28-34021 Set 28-3402S	IN / EX 60-60060 O/S +.001 60-60061	2249-11N (Intake) 2250-1E (Exhaust)	CC-3403	HR4059	04921	Bearing / Seal Kit 49K049	
434cc 94.00mm 440cc 94.50mm 443cc 95.00mm 450cc 95.50mm					94.50 96.00 96.50	.180 .240 .260		4796M09450	8563D550			C3138-EST (96mm)			28-34022 Exhaust 28-34021 Set 28-3402S	O/S +.001 60-60061						
COMPLETE CYLINDER KIT INCLUDES BIG BORE CYLINDER, PISTON KIT, AND TOP END GASKET KIT.												Top End GS5430 (97mm)			Valve Springs 60-60045							
Bearcat 454 4x4 Bearcat 454 2x4	1996-98 1997-98	CI	FL-5326									C7308	35-0800									
454cc Liquid Cooled 84mm 3.307"												Complete 37-1800										
XC 450 443cc Liquid Cooled 89mm 3.504"	2011-13	AC	FL-5766																			
450 Alterra 450 CORE 450i 450 TRV	2016-24 2013-15 2011-12 2011-12	AC	FL-5766										35-0015									
454cc Liquid Cooled 84mm 3.307"																						
500 H1 500 XT 500 TRV 500 Alterra	2013-17 2013-17 2013-17 2016-17	AC	FL-5766										35-0015									
443cc Liquid Cooled 89mm 3.504"																						
Prowler 500 500 HDX	2014-22 2016-17	AC	FL-5766																			
443cc Liquid Cooled 89mm 3.504"																						
500 4x4 500 4x4 Auto	1998-09 2000-09	AC	FL-5370										35-0828									
493cc Liquid Cooled 87.5mm 3.444"												Complete w/oil seals 37-1828 (manual) 37-1839 (auto)										

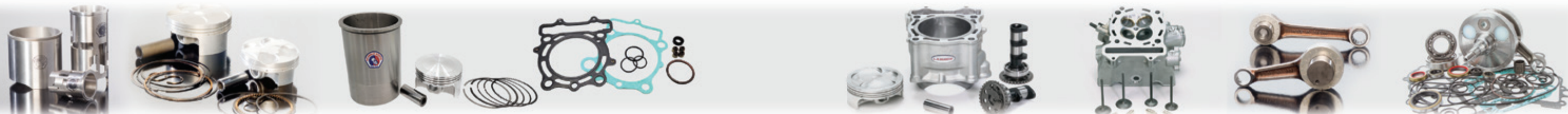

ATV-UTV ARCTIC CAT
ATV-UTV BOMBARDIER
ATV-UTV HONDA
ATV-UTV KAWASAKI
ATV-UTV KTM/KYMCO
ATV-UTV POLARIS
ATV-UTV SUZUKI
ATV-UTV YAMAHA
PERSONAL WATERCRAFT



MODEL
Engine Description
Cylinder I.D. (mm/in.)



SLEEVE

REBUILD KIT
Sleeve • Piston
Gasket • T.E. Bearing

BORE SIZE (mm)

PISTON SIZE

TOP END

TOP END

VALVE TRAIN

BOTTOM END

PRO-X PISTON

LAPC PISTON

WISECO PISTON

WOSSNER PISTON

VERTEX PISTON

JE PISTON

COMETIC GASKET

L.A. SLEEVE GASKET

CYLINDER AFTERMARKET KITS

VALVE / SPRING KIT

VALVE GUIDE

CAMSHAFT

CAM CHAIN

CRANKSHAFT

CON-ROD KIT

CRANK BEARING

ENGINE OIL SEAL KIT

BOMBARDIER CAN-AM ATV-UTV FOUR-STROKE

MODEL	Year	CI	FL	BORE	STROKE	PRO-X PISTON	LAPC PISTON	WISECO PISTON	WOSSNER PISTON	VERTEX PISTON	JE PISTON	COMETIC GASKET	L.A. SLEEVE GASKET	CYLINDER AFTERMARKET KITS	VALVE / SPRING KIT	VALVE GUIDE	CAMSHAFT	CAM CHAIN	CRANKSHAFT	CON-ROD KIT	CRANK BEARING	ENGINE OIL SEAL KIT					
DS90 90cc 47mm	2002-05	CI	FL-5615												Top End 35-0855												
DS90 90cc 50mm	2006-07	CI	FL-5616																								
DS90 90cc 50mm	2008-23	CI	FL-5696																								
Rally 200 176cc Single Liquid Cooled 62mm	2004-07	AC	FL-5617																								
DS250 249cc Single Liquid Cooled 71mm	2006-24	AC	FL-5618																								
Outlander 330 H.O. 325cc Single Liquid Cooled 82mm	2003-05	RS/CS	FL-5620	82.00 82.50	Std. .020																		HR00062 Rod Bolts HR00092	49-822388 Main Bearing / Seal Kit 49K101			
Outlander 400 H.O. EFI 400cc Single Liquid Cooled 91mm	2005-15	CI	FL-5619	91.00 91.50 92.00 93.00 91.00 92.00 93.00	Std. .020 .040 .080 Std. .040 .080			11.5:1 Comp. 40030M09100 40030M09200 40030M09300 13:1 Comp. 40031M09100 40031M09200 40031M09300							Top End 35-0957	Steel Intake 91-91162 Steel Exhaust 91-91166 Valve Spring Kit 91-91156	Valve Guide Intake 91-91170 Exhaust 91-91180							HR00062 Rod Bolts HR00092	49-822388 Main Bearing / Seal Kit 49K101		
Outlander 450 HD5 Defender HD5 427cc Single Liquid Cooled 94mm	2014-24 2017-20	CS	FL-5788	94.00 94.50	Std. .020										Top End 35-0979	2016-20 Steel Intake 91-91212 Steel Exhaust 91-91216 Valve Spring Kit 91-91200	2016-20 Valve Guide IN / EX 91-91220 O/S+.001 91-91221								HR00062 Rod Bolts HR00092	49-822390	
DS450 449cc Single Liquid Cooled 97mm	2008-15	AC	FL-5672	97.00 97.00 97.00 97.00	Std. Std. Std. Std.			11.8:1 Comp. 40026M09700 13:1 Comp. 40027M09700							Top End C3266-EST	Steel Intake 91-91112 Steel Exhaust 91-91116 Valve Spring Kit 91-91000	Valve Guide Intake 91-91120 O/S+.001 91-91121 Exhaust 91-91130 O/S+.001 91-91131										
Outlander 500 H.O. EFI Renegade 500 H.O. EFI 500cc V-Twin Liquid Cooled 82mm	2007-15 2008-15	RS/CS	FL-5620	5620K-1 82.00 82.50 83.00	Std. .020 .040			Stock Comp. 40028M08200 40028M08250 40028M08300							Top End 35-0954 Complete w/oil seals 37-1954	Steel Intake 91-91162 Steel Exhaust 91-91166 Valve Spring Kit 91-91150 (07-15)	Valve Guide Intake 91-91170 O/S+.001 91-91171 Exhaust 91-91180 O/S+.001 91-91181										49-822362 Main Bearing / Seal Kit 49K102



ATV-UTV
ARCTIC CAT

ATV-UTV
BOMBARDIER

ATV-UTV
HONDA

ATV-UTV
KAWASAKI

ATV-UTV
KTM/KYMCO

ATV-UTV
POLARIS

ATV-UTV
SUZUKI

ATV-UTV
YAMAHA

PERSONAL
WATERCRAFT



MODEL
Engine Description
Cylinder I.D. (mm/in.)

SLEEVE

REBUILD KIT
Sleeve, Piston
Gasket, T.E. Bearing

BORE SIZE
(mm)

PISTON SIZE

TOP END

TOP END

VALVE TRAIN

BOTTOM END

PRO-X PISTON

LAPC PISTON

WISECO PISTON

WOSSNER PISTON

VERTEX PISTON

JE PISTON

COMETIC GASKET

L.A. SLEEVE GASKET

CYLINDER AFTERMARKET KITS

VALVE / SPRING KIT

VALVE GUIDE

CAMSHAFT

CAM CHAIN

CRANKSHAFT

CON-ROD KIT

CRANK BEARING

ENGINE OIL SEAL KIT

BOMBARDIER CAN-AM ATV-UTV FOUR-STROKE (CONTINUED)

MODEL	FL	Stock Comp.	Top End	Top End	Valve Train	Bottom End
Outlander 570 EFI 2016-23 Renegade 570 EFI 2016-22 570cc V-Twin Liquid Cooled 84mm 3.307"	CS FL-5789	40286M08400	Top End 35-0985 Complete 37-8985		Steel Intake 91-91162 Steel Exhaust 91-91166 Valve Guide Intake 91-91170 O/S+.001 91-91171 Exhaust 91-91180 O/S+.001 91-91181	49-822362 Main Bearing / Seal Kit 49K102
DS650 through 2007 653cc Liquid Cooled 100mm 3.937"	AC FL-5467		Top End C7711 (01-04) Complete w/oil seals 37-1853	Top End 35-0853	Steel Intake 91-91015 Steel Exhaust 91-91017	49-822203
DS650 Big Bore to 719cc 105mm 4.134"	BB FL-5467B		Top End C7722			
Outlander 650 H.O. EFI 2006-24 Renegade 650 2022-24 650cc V-Twin Liquid Cooled 82mm 3.228"	RS/CS FL-5620	5620K-2 40029M08200 40029M08250 40029M08300	Top End 35-0986 Complete 37-8986	Stock Comp. VT24565 VT24565050	Steel Intake 91-91162 Steel Exhaust 91-91166 Valve Spring Kit 91-91150 (06-14) Valve Guide Intake 91-91170 O/S+.001 91-91171 Exhaust 91-91180 O/S+.001 91-91181	49-822362 Main Bearing / Seal Kit 49K102 Rod Bolts HR00092
Outlander 800 H.O. EFI 2006-15 Renegade 800 H.O. EFI 2008-15 800cc V-Twin Liquid Cooled 91mm 3.582"	CI FL-5619	5619K 11.5:1 Comp. 40030M09100 40030M09200 40030M09300 12.5:1 Comp. 40031M09100 40031M09200 40031M09300	Top End C3549-EST (92mm) C3460-EST (93mm) Top End 35-0956 Complete w/oil seals 37-1956 (06-12) 800R 37-1957 (13-15)	11.5:1 Comp. 292761 VT24563 VT24563050 12.5:1 Comp. 300183 (Set) (843cc) 13.5:1 Comp. 300184 (Set) (843cc)	Steel Intake 91-91162 Steel Exhaust 91-91166 Valve Spring Kit 91-91150 (thru 2014) Valve Guide Intake 91-91170 O/S+.001 91-91171 Exhaust 91-91180 O/S+.001 91-91181	CC-5513 HR00064 HR00062 Rod Bolts HR00092 Main Bearing / Seal Kit 49K102
Commander 800 H.O. EFI 2011-20 Defender 800 HD8 2017-21 Maverick Trail 800R 2017-21 Traxter 800 HD8 2018-20 800cc V-Twin Liquid Cooled 91mm 3.582"	CI FL-5619	11.5:1 Comp. 40030M09100 40030M09200 40030M09300	Top End C3549-EST (92mm) C3460-EST (93mm) Top End 35-0956 Complete w/oil seals 37-1363	11.5:1 Comp. VT24563 VT24563050		CC-5513 Commander HR00064 HR00062 Rod Bolts HR00092 49-822362
Outlander 850 EFI 2016-23 Renegade 850 EFI 2016-22 854cc V-Twin Liquid Cooled 94mm 3.700"	CI FL-5790	Stock Comp. VT24567 VT24567050	Top End 35-0987		Steel Intake 91-91212 Steel Exhaust 91-91216 Valve Spring Kit 91-91200 (thru 2020) Valve Guide IN / EX 91-91220 O/S+.001 91-91221	CC-5513 HR00064 (16-19) Without Rods HR00063 49-822362

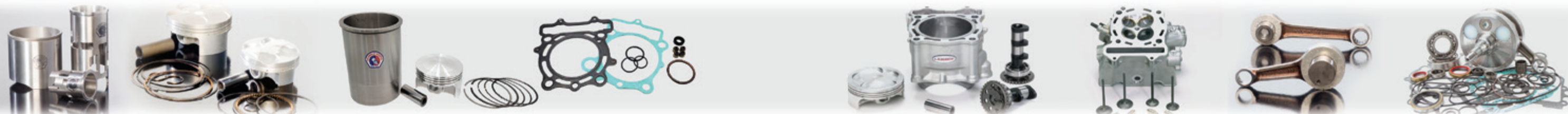

ATV-UTV ARCTIC CAT
BOMBARDIER
ATV-UTV HONDA
ATV-UTV KAWASAKI
ATV-UTV KTM/KYMCO
ATV-UTV POLARIS
ATV-UTV SUZUKI
ATV-UTV YAMAHA
PERSONAL WATERCRAFT



MODEL
Engine Description
Cylinder I.D. (mm/in.)



SLEEVE

REBUILD KIT
Sleeve • Piston
Gasket • T.E. Bearing

BORE SIZE
(mm)

PISTON SIZE

TOP END

TOP END

VALVE TRAIN

BOTTOM END

PRO-X PISTON

LAPC PISTON

WISECO PISTON

WOSSNER PISTON

VERTEX PISTON

JE PISTON

COMETIC GASKET

L.A. SLEEVE GASKET

CYLINDER AFTERMARKET KITS

VALVE / SPRING KIT

VALVE GUIDE

CAMSHAFT

CAM CHAIN

CRANKSHAFT

CON-ROD KIT

CRANK BEARING

ENGINE OIL SEAL KIT

BOMBARDIER CAN-AM-UTV ATV FOUR-STROKE (CONTINUED)

<p>Maverick X3 HO 2017-24 Maverick X3 Max Turbo ACE 900cc Triple Liquid Cooled 74mm 2.913" <i>**Set of 3 Ductile Iron Racing Sleeves Closed Deck Siamese Flanged</i> <i>Note: Special CNC Machining Required For Sleeve Installation</i></p>	<p>AC FL-5809 AC/MO FL5809CDX3</p>		74.00	Std.			9.1:1 Comp. K4040DA-3 (Turbo)	9.1:1 Comp. VT24537 x3 (Turbo)	9.1:1 Comp. 366830 (3) (Turbo)					Steel Intake 91-91312H Inconel Steel Exhaust 91-91316K Valve Spring Kit 91-91300	Valve Guide IN / EX 91-91320M O/S+.001 91-91321M						
<p>1000R 2011-24 Outlander 1000 2012-24 Renegade 1000 2012-24 976cc V-Twin Liquid Cooled 91mm 3.582"</p>	<p>CI FL-5775</p>		91.00 91.50	Std. .020			11:1 Comp. 40153M09100	Stock Comp. VT24568 VT24568050	9:1 Comp. 308411 (Set of 2)		Top End Outlander (12-21) C3459-EST	Top End Outlander 35-0956 (*12-17) 35-0978 (*18-22)	C3460-EST (93mm)	Steel Intake 91-91212 Steel Exhaust 91-91216 Valve Spring Kit 91-91200 (thru 2020)	Valve Guide IN / EX 91-91220 O/S+.001 91-91221		CC-044 (11-20)	Hot Rods HR00094 without rods (Thru 2023)	Hot Rods HR00179 (12-19)		49-822362
<p>Commander 1000 2011-24 Defender 1000 HD9 2021-22 Defender 1000 HD10 2016-24 Maverick 1000R 2013-24 976cc V-Twin Liquid Cooled 91mm 3.582"</p>	<p>CI FL-5775</p>		91.00 91.50 93.00	Std. .020 .080		11:1 Comp. 40153M09100 40153M09300	Commander 11:1 Comp. 40153M09100	Stock Comp. VT24568 VT24568050	Commander 12.5:1 Comp. 308414 (2)		Top End C3459-EST	Top End Commander 35-0956 (11-17) 35-0978 (18-22)	C3460-EST (93mm)	Steel Intake 91-91212 Steel Exhaust 91-91216 Valve Spring Kit 91-91200 (thru 2020)	Valve Guide IN / EX 91-91220 O/S+.001 91-91221		CC-044	Hot Rods Commander Maverick HR00094 without rods (Thru 2018)	Hot Rods HR00179 (11-20)		49-822362
			91.00 92.00	Std. .040		Maverick 12:1 Comp. 40152M09100 40152M09200			Maverick 12.5:1 Comp. 324953 (2)			Defender 35-0956 (16-19) 35-0978 (20-22)									



ATV-UTV
ARCTIC CAT

ATV-UTV
BOMBARDIER

ATV-UTV
HONDA

ATV-UTV
KAWASAKI

ATV-UTV
KTM/KYMCO

ATV-UTV
POLARIS

ATV-UTV
SUZUKI

ATV-UTV
YAMAHA

PERSONAL
WATERCRAFT



MODEL
Engine Description
Cylinder I.D. (mm/in.)



SLEEVE

REBUILD KIT
Sleeve - Piston
Gasket - T.E. Bearing

BORE SIZE (mm)

PISTON SIZE

TOP END

TOP END

BOTTOM END

PRO-X PISTON

LAPC PISTON

WISECO PISTON

WOSSNER PISTON

VERTEX PISTON

T.E. BEARING

COMETIC GASKET

L.A. SLEEVE GASKET

CRANKSHAFT

CON-ROD KIT

CON-ROD ASSEMBLY
Rod - Bearings - Seals

CRANK BEARING

CRANK SEAL KIT

HONDA ATV-UTV TWO-STROKE

MODEL	Engine Description	Cylinder I.D. (mm/in.)	SLEEVE	REBUILD KIT	BORE SIZE (mm)	PISTON SIZE	PRO-X PISTON	LAPC PISTON	WISECO PISTON	WOSSNER PISTON	VERTEX PISTON	T.E. BEARING	COMETIC GASKET	L.A. SLEEVE GASKET	CRANKSHAFT	CON-ROD KIT	CON-ROD ASSEMBLY	CRANK BEARING	CRANK SEAL KIT								
ATC-250R 247cc 70mm SPECIAL HEAVY O.D. TO REPAIR BROKEN CYLINDER SKIRT	1981-84 Single 2.756"	H-106	106K		70.00	Std.			431M07000	8154DA		T.E. Bearing 01181	Top End C7021			Hot Rods HR8160		6328C3									
										431M07050	8154D050																
									H-106H		431M07100	8154D100															
											431M07150	8154D150															
											431M07200	8154D200															
ATC-250R Four Trax 250R 246cc 66mm SPECIAL HEAVY O.D. TO REPAIR BROKEN CYLINDER SKIRT	1985-86 Liquid Cooled 2.598"	CI	H-845	845K	66.00	Std.			526M06600	8156DA		T.E. Bearing 01181	Top End C7349	Complete 36-8814	HR4006	Pro-X 04980	39-4980X	6328C3	094971								
						66.25	.010		526M06625	8156D025																	
						66.50	.020		526M06650	8156D050																	
						66.75	.030		526M06675	8156D075																	
						67.00	.040		526M06700	8156D100																	
						67.25	.050		526M06725	8156D125																	
						67.50	.060		526M06750	8156D150																	
						67.75	.070																				
						68.00	.080																				
						68.25	.090																				
						68.50	.100						526M06850	8156D250													
						69.00	.120						526M06900	8156D300													
						69.50	.140						526M06950	8156D350													
					ATC-295R Big Bore TRX-295R Big Bore 295cc to 310cc 72mm (HEAD MODIFICATION REQUIRED)	1985-86 Liquid Cooled 2.835"	H-845B			72.00	Std.		Forged				T.E. Bearing 01181	Top End GS845			Pro-X 04980	39-4980X	6328C3	094971			
											72.25	.010		W845PS													
	72.50	.020		W845P1																							
	73.00	.040		W845P2																							
	73.50	.060		W845P4																							
Four Trax TRX-250R 246cc 66mm SPECIAL HEAVY O.D. TO REPAIR BROKEN CYLINDER SKIRT	1987-89	CI	H-5032	5032K	66.00	Std.	4320	Cast				T.E. Bearing 01181	Top End C7349	Complete 36-8814	HR4007	Hot Rods HR8109	39-4971	6328C3	094971								
						66.50	.020	4322	PX845PS																		
						67.00	.040	4324																			
						67.50	.060	4326																			
						68.00	.080	4328																			
TRX-295R Big Bore 295cc to 310cc 72mm (HEAD MODIFICATION REQUIRED) MUST USE BASE PLATE NO. BSP845 WITH W845 PISTON	1987-89	H-5032B			72.00	Std.		W845PS				T.E. Bearing 01181	Top End GS845			Hot Rods HR8109	39-4971	6328C3	094971								
						72.25	.010		W845P1																		
						72.50	.020		W845P2																		
						73.00	.040		W845P4																		
						73.50	.060		W845P6								Base Plate BSP845		ProX 04971								

ATV-UTV
ARCTIC CAT

ATV-UTV
BOMBARDIER

ATV-UTV
HONDA

ATV-UTV
KAWASAKI

ATV-UTV
KTM/KYMCO

ATV-UTV
POLARIS

ATV-UTV
SUZUKI

ATV-UTV
YAMAHA

PERSONAL
WATERCRAFT





MODEL
Engine Description
Cylinder I.D. (mm/in.)

SLEEVE

REBUILD KIT
Sleeve - Piston
Gasket - T.E. Bearing

BORE SIZE (mm)

PISTON SIZE

TOP END

TOP END

BOTTOM END

PRO-X PISTON

LAPC PISTON

WISECO PISTON

WOSSNER PISTON

VERTEX PISTON

T.E. BEARING

COMETIC GASKET

L.A. SLEEVE GASKET

CRANKSHAFT

CON-ROD KIT

CON-ROD ASSEMBLY
Rod - Bearings - Seals

CRANK BEARING

CRANK SEAL KIT

HONDA ATV-UTV TWO-STROKE (CONTINUED)

NIKS PROCROSS 310 KITS		BB	BORE SIZE (mm)	PISTON SIZE	PRO-X PISTON	LAPC PISTON	WISECO PISTON	WOSSNER PISTON	VERTEX PISTON	T.E. BEARING	COMETIC GASKET	L.A. SLEEVE GASKET	CRANKSHAFT	CON-ROD KIT	CON-ROD ASSEMBLY Rod - Bearings - Seals	CRANK BEARING	CRANK SEAL KIT
ATC/TRX-250R 1985-89 295cc to 310cc 72mm 2.835"																	
Replacement Sleeve With Bridged Exhaust Port	RS LAS-372				87-89 Years Must Use Base Plate With W845 Pistons & Stock Crank							Complete w/oil sels 37-8814 & GS300		Hot Rods Bottom End Kit CBK0042 (85-86) CBK0043 (87-89) Includes Crankshaft, Bearings Seals, Complete Gasket Set			
Replacement Sleeve With Oval Exhaust Port, PV Cylinder	RS LAS-3720V1												Base Plate BSP845				
Replacement Sleeve With Oval Exhaust Port Non PV	RS LAS-3720V																
Replacement Sleeve ESR Cylinder With Bridged Exhaust	RS/MO ESR-295																
Replacement Sleeve ESR Cylinder With Oval Exhaust	RS/MO ESR-2950V																
NIKS PROCROSS 330 KITS																	
323cc to 330cc 76mm 2.992"		BB	76.00 76.50 77.00 77.50 78.00	Std. .020 .040 .060 .080						T. E. Bearing 1181		Top End GS330					
Replacement Sleeve With Bridged Exhaust Port	RS LAS-376				87-89 Years Must Use Base Plate With W330 Pistons & Stock Crank							Base Plate BSP845					
Replacement Sleeve With Oval Exhaust Port	RS LAS-3760V																
Replacement Sleeve ESR Cylinder With Bridged Exhaust	RS/MO ESR-329																
Replacement Sleeve ESR Cylinder With Oval Exhaust	RS/MO ESR-3290V																
NIKS PROCROSS 350 KITS																	
77.50mm 3.051" to 78.50mm 3.091"		BB	77.50 78.00 78.50	.060 .080 .100						T. E. Bearing 1181		Top End GS350					
Replacement Sleeve With Bridged Exhaust Port	RS LAS-378																
Replacement Sleeve With Oval Exhaust Port, PV Cylinder	RS LAS-3780V1																
Replacement Sleeve With Oval Exhaust Port Non PV	RS LAS-3780V																
Replacement Sleeve ESR Cylinder With Bridged Exhaust	RS/MO ESR-349																
Replacement Sleeve ESR Cylinder With Oval Exhaust	RS/MO ESR-3490V																

MO = Made to Order



ATV-UTV ARCTIC CAT
ATV-UTV BOMBARDIER
ATV-UTV HONDA
ATV-UTV KAWASAKI
ATV-UTV KTM/KYMCO
ATV-UTV POLARIS
ATV-UTV SUZUKI
ATV-UTV YAMAHA
PERSONAL WATERCRAFT



MODEL
Engine Description
Cylinder I.D. (mm/in.)



SLEEVE

REBUILD KIT
Sleeve • Piston
Gasket • T.E. Bearing

BORE SIZE (mm)

PISTON SIZE

TOP END

TOP END

BOTTOM END

PRO-X PISTON

LAPC PISTON

WISECO PISTON

WOSSNER PISTON

VERTEX PISTON

T.E. BEARING

COMETIC GASKET

L.A. SLEEVE GASKET

CRANKSHAFT

CON-ROD KIT

CON-ROD ASSEMBLY
Rod • Bearings • Seals

CRANK BEARING

CRANK SEAL KIT

HONDA ATV-UTV TWO-STROKE (CONTINUED)

MODEL	Year	CI/MO	H	BORE SIZE (mm)	PISTON SIZE	PRO-X PISTON	LAPC PISTON	WISECO PISTON	WOSSNER PISTON	VERTEX PISTON	T.E. BEARING	COMETIC GASKET	L.A. SLEEVE GASKET	CRANKSHAFT	CON-ROD KIT	CON-ROD ASSEMBLY	CRANK BEARING	CRANK SEAL KIT	
Odyssey 250 247cc 70mm	1977-84 2.756"	CI/MO	H-91	70.00 70.50 71.00 71.50 72.00	Std. .020 .040 .060 .080			338M07000 338M07050 338M07100 338M07150 338M07200			T.E. Bearing 01181	Top End C7140					6306C3		
ATC-300 Honda Kit Cylinder 299cc 76mm	1981-84 2.992"	CS/MO	H-115																
Odyssey 350 329cc 78.5mm	1985-86 Single 3.090"	CS	H-896	80.00 80.50 81.00 81.50 82.00	.060 .080 .100 .120 .140			533M08000 533M08050 533M08100 533M08200			T.E. Bearing 01181	Top End C7229					Left 6307N Right 6306C3		
Pilot FL-400R 397cc 80mm	1989-92 Liquid Cooled 3.150"	CI	H-5088	80.00 81.00 82.00	Std. .040 .080			577M08000 577M08100 577M08200			T.E. Bearing 01320	Top End C7024					Left 6306C3		



ATV-UTV
ARCTIC CAT

ATV-UTV
BOMBARDIER

ATV-UTV
HONDA

ATV-UTV
KAWASAKI

ATV-UTV
KTM/KYMCO

ATV-UTV
POLARIS

ATV-UTV
SUZUKI

ATV-UTV
YAMAHA

PERSONAL
WATERCRAFT



MODEL
Engine Description
Cylinder I.D. (mm/in.)



SLEEVE

REBUILD KIT
Sleeve - Piston
Gasket - T.E. Bearing

BORE SIZE (mm)

PISTON SIZE

TOP END

TOP END

VALVE TRAIN

BOTTOM END

PRO-X PISTON

LAPC PISTON

WISECO PISTON

WOSSNER PISTON

VERTEX PISTON

JE PISTON

COMETIC GASKET

L.A. SLEEVE GASKET

CYLINDER AFTERMARKET KITS

VALVE / SPRING KIT

VALVE GUIDE

CAMSHAFT

CAM CHAIN

CRANKSHAFT

CON-ROD KIT

CRANK BEARING

ENGINE OIL SEAL KIT

HONDA ATV-UTV FOUR-STROKE

MODEL	Year	CC	Cylinder	Bore (mm)	Stroke (mm)	Compression	PRO-X PISTON	LAPC PISTON	WISECO PISTON	WOSSNER PISTON	VERTEX PISTON	JE PISTON	COMETIC GASKET	L.A. SLEEVE GASKET	CYLINDER AFTERMARKET KITS	VALVE / SPRING KIT	VALVE GUIDE	CAMSHAFT	CAM CHAIN	CRANKSHAFT	CON-ROD KIT	CRANK BEARING	ENGINE OIL SEAL KIT	
ATC-70 TRX-70 72cc 47mm	1978-85 1986-87 Single 1.850"	CC	H-100										Top End C7228 ATC C7227 TRX			(IN / EX Set) 07-001			6306C3		Pro-X 31050	6304C3		
TRX-90R TRX-90EX, X 86cc 47mm	1993-06 2007-24 Single 1.850"	CC	H-5229										Top End C7226-EST	Top End 35-0842 (93-05) 35-0906 (06-24)		(IN / EX Set) 07-023						6304C3	49-822314	
ATC-110 105cc 52mm	1979-85 Single 2.047"	CS	H-102	53.50	.060	(81-85) 2416																		
ATC-125M 124cc 55mm	1984-85 Single 2.165"	CS/L	H-840																					
ATC-125M 125cc 54mm	1986-87 Single 2.126"	CS	H-987										Top End C7225										6328C3	
TRX-125 124cc 55mm	1985-86 Single 2.165"	CS/L	H-840										Top End C7224											
TRX-125 125cc 54mm	1987-88 Single 2.126"	CS	H-987										Top End C7223											6328C3
ATC-185 180cc 63mm	1980-83 Single 2.480"	CS	H-3	63.00 63.25 63.50 63.75 64.00 64.25 64.50 65.00 65.50 66.00 66.50	Std. .010 .020 .030 .040 .050 .060 .080 .100 .120 .140	2423 2424 2425 2426			10.25:1 Comp. 4362M06500 4156M06550 4156M06600 4156M06650				Top End C7025	Top End 35-1270		(IN / EX Set) 07-004 Valve Springs 30-4021	Valve Guide IN / EX 30-4069 O/S +.001 30-4070				Pro-X 01351	6328C3		
ATC-200, E, ES, M TRX-200 192cc 65mm	1981-86 1984 Single 2.559"	CI	H-103	103K (10.25:1) 103K-1 (12:1) 65.00 65.25 65.50 65.75 66.00 66.50 67.00	Std. .010 .020 .030 .040 .060 .080	2430 2431 2432 2433 2434 2436	10.25:1 Comp. 4362M06500	10.25:1 Comp. 8813DA					Top End C7025	Top End 35-1270		(IN / EX Set) 07-004 Valve Springs 30-4021	Valve Guide IN / EX 30-4069 O/S +.001 30-4070				Pro-X 01351	6328C3	49-822341	
				65.00 65.50 66.00	Std. .020 .040				12:1 Comp. 4289M06500 4289M06550 4289M06600															

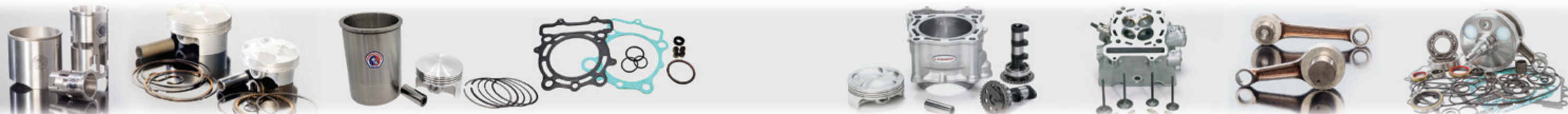

ATV-UTV ARCTIC CAT
ATV-UTV BOMBARDIER
ATV-UTV HONDA
ATV-UTV KAWASAKI
ATV-UTV KTM/KYMCO
ATV-UTV POLARIS
ATV-UTV SUZUKI
ATV-UTV YAMAHA
PERSONAL WATERCRAFT

MODEL
Engine Description
Cylinder I.D. (mm/in.)

SLEEVE

REBUILD KIT
Sleeve • Piston
Gasket • T.E. Bearing

BORE SIZE (mm)

PISTON SIZE

TOP END

TOP END

VALVE TRAIN

BOTTOM END

PRO-X PISTON

LAPC PISTON

WISECO PISTON

WOSSNER PISTON

VERTEX PISTON

JE PISTON

COMETIC GASKET

L.A. SLEEVE GASKET

CYLINDER AFTERMARKET KITS

VALVE / SPRING KIT

VALVE GUIDE

CAMSHAFT

CAM CHAIN

CRANKSHAFT

CON-ROD KIT

CRANK BEARING

ENGINE OIL SEAL KIT

HONDA ATV-UTV FOUR-STROKE (CONTINUED)

MODEL	Year	CS	H	989K	65.00	Std.	10.25:1 Comp.	10.25:1 Comp.					Top End	Top End		(IN / EX Set)										
ATC-200X	1986-87	CS	H-989	989K	65.00	Std.	10.25:1 Comp.	10.25:1 Comp.					Top End	Top End		(IN / EX Set)								6328C3	49-822341	
TRX-200SX	1986-88			(10.25:1)	65.25	.010	2440	4394M06500					C7222	35-1268		07-015										
Fat Cat 200	1986-87				65.50	.020	2441																			
199cc	Single				65.50	.020	2442	4394M06550																		
65mm	2.559"				65.75	.030	2443																			
					66.00	.040	2444	4394M06600																		
TRX-200	1990-91	CS	H-989	989K-2	65.00	Std.	2450						Top End	Top End		(IN / EX Set)								6328C3	49-822255	
TRX-200D	1991-97				65.25	.010	2451						C7222	35-1268		07-015										
199cc	Single				65.50	.020	2452																			
65mm	2.559"				65.75	.030	2453																			
					66.00	.040	2454																			
					66.50	.060	2456																			
ATC-250, SX, ES	1985-87	RS	H-5028		74.00	Std.							Top End	Complete		(IN / EX Set)							Pro-X		49-822168	
TRX-250	1985-87												C7026	w/oil seals		07-019							01354			
246cc	Single													37-1802												
74mm	2.913"															Valve Springs										
																30-4105										
Four Trax 250X	1987-88	RS	H-5028	5028K	74.00	Std.	Stock Comp.	12:1 Comp.					Top End	Top End		(IN / EX Set)	Valve Guide	Hot Cams	CC-021				Pro-X		6328C3	
TRX-250	1991-92				74.50	.020	2460	4440M07400					C7143-EST	35-1430		07-0162	IN / EX	Camshaft					01354			
246cc	Single				75.00	.040	2464	4440M07450								(1987-92)	30-3030	1058-1								
74mm	2.913"				75.50	.060	2466	4440M07500								Valve Springs	O/S +.002									
					76.00	.080		4440M07550								30-3041	30-3032									
								4440M07600																		
TRX-250D Recon	1997-01	RS	H-5366	5366K	68.50	Std.	9.2:1 Comp.							Top End		(IN / EX Set)			CC-026						6207C3	49-822211
229cc	Single				69.00	.020	2610							35-0841		07-021										
68.5mm	2.697"				69.50	.040	2612																			
							2614																			
TRX-250EX, Sportrax	2001-08	CS	H-5560	5560K	68.50	Std.	10:1 Comp.	10:1 Comp.	10:1 Comp.	9.2:1 Comp.			Top End	Top End		(IN / EX Set)			CC-026	Hot Rods	Hot Rods			6207C3		
Fourtrax 250 X, Recon	2002-24				69.00	.020	2620	40061M06850	8870DA	VT24257			C3153-EST	35-0888		07-026					HR4411	HR8691			Bearing / Seal Kit	
TRX-250 TE, TM	2002-24				69.50	.040	2622	40061M06900	8870D050	VT24257050						TRX-250EX					(thru 2019)	(thru 2019)			49K077	
229cc	Single															(01-08)										
68.5mm	2.697"				68.50	Std.		10.5:1 Comp.								07-032										
					69.00	.020		4935M06850								TRX-250 TE, TM										
					69.50	.040		4935M06900								(02-24)										
								4935M06950																		
								(TRX-250EX)																		
								(01-08)																		
TRX-300 FW 2 Valve	1988-00	RS	H-5062		74.00	Std.	10.25:1 Comp.	10.5:1 Comp.						Top End		(IN / EX Set)			CC-1393				Pro-X		49-822168	
TRX-300	Single				74.50	.020	2470	4629M07400						35-1400		07-020							01357			
282cc	Single				74.75	.030	2472	4629M07450																		
74mm	2.913"				75.00	.040	2473																			
					75.50	.060	2474	4629M07500																		
					76.00	.080	2476	4629M07550																		
								4629M07600																		
TRX-300 EX, X 4 Valve	1993-09	RS	H-5062	5062K	74.00	Std.	11:1 Comp.	11:1 Comp.	11:1 Comp.				Top End	Top End		(IN / EX Set)	Valve Guide	Hot Cams	CC-1393				Pro-X		49-822146	
282cc	Single				74.25	.010	2590	4574M07400	8675DA				C7143-EST	35-1430		07-0162	IN / EX	Camshaft					01357			
74mm	2.913"				74.50	.020	2591						(75mm)			30-3030	1058-1									
					75.00	.040	2592	4574M07450	8675D050							Valve Springs										
					75.50	.060	2496	4574M07500	8675D100							30-3041										
					76.00	.080		4574M07550	8675D150							O/S +.002										
								4574M07600	8675D200							30-3032										

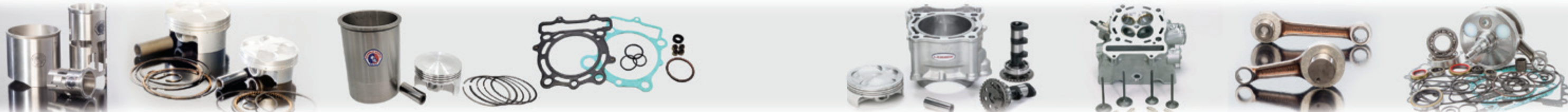

ATV-UTV ARCTIC CAT
ATV-UTV BOMBARDIER
ATV-UTV HONDA
ATV-UTV KAWASAKI
ATV-UTV KTM/KYMCO
ATV-UTV POLARIS
ATV-UTV SUZUKI
ATV-UTV YAMAHA
PERSONAL WATERCRAFT



MODEL
Engine Description
Cylinder I.D. (mm/in.)

SLEEVE

REBUILD KIT
Sleeve - Piston
Gasket - T.E. Bearing

BORE SIZE (mm)

PISTON SIZE

TOP END

TOP END

VALVE TRAIN

BOTTOM END

PRO-X PISTON

LAPC PISTON

WISECO PISTON

WOSSNER PISTON

VERTEX PISTON

JE PISTON

COMETIC GASKET

L.A. SLEEVE GASKET

CYLINDER AFTERMARKET KITS

VALVE / SPRING KIT

VALVE GUIDE

CAMSHAFT

CAM CHAIN

CRANKSHAFT

CON-ROD KIT

CRANK BEARING

ENGINE OIL SEAL KIT

HONDA ATV-UTV FOUR-STROKE (CONTINUED)

MODEL	Year	Configuration	Stroke	Cylinder I.D. (mm)	Stroke (mm)	Compression Ratio	10.25:1 Comp. Part	10.25:1 Comp. Part	12:1 Comp. Part	8.8:1 Comp. Part	8.8:1 Comp. Part	8.8:1 Comp. Part	8.8:1 Comp. Part	8.8:1 Comp. Part	Top End Part	Top End Part	Cylinder Kit	Valve / Spring Kit	Valve Guide	Camshaft	Cam Chain	Crankshaft	Con-Rod Kit	Crank Bearing	Engine Oil Seal Kit
ATC-350X Four Trax 350 350cc 81mm	1985-86 1986-89	RS/L	H-952	81.00 81.50 82.00	Std. .020 .040		4393M08100 4393M08150 4393M08200	8598DA 8598D050 8598D100	4396M08100 4396M08150 4396M08200					Top End C7402 (ATC)			(IN / EX Set) 07-0182								
TRX350TM Rancher TRX350ES Rancher 329cc 78.5mm	2000-06 2000-09	RS	H-5443	78.50 79.00 79.50 80.00	Std. .020 .040 .060	8.8:1 Comp. 01.1480.000 01.1480.050 01.1480.100 01.1480.150	4933M07850 4933M07900 4933M07950	8871DA 8871D050 8871D100	VT24258 VT24258050 VT24258100					Top End 35-0867 Complete w/oil seals 37-1867		Cylinder 05011 (Std. 78.5mm) Complete Cylinder Kit 05011-K01 (Std. 78.5mm)				CC-1480 (00-06)	Hot Rods HR4409 (00-06)	Hot Rods HR8698 (00-06)	Bearing / Seal Kit 49K078		49-822236
TRX-400FW 4x4 Foreman 400 395cc 86mm	1995-04	RS	H-5286	86.00 86.50 87.00	Std. .020 .040	8.2:1 Comp. 2660 2662 2664	4669M08600 4669M08700	8599DA 8599D050 8599D100						Top End C7301	Top End 35-0858 Complete w/oil seals 37-1858		(IN / EX Set) 07-024				CC-1485				49-822208
TRX-400 EX TRX-400 X 4 Valve 397cc 85mm	1999-09 2009-14	RS	H-5293	85.00 85.25 85.50 85.75 86.00 87.00	Std. .010 .020 .030 .040 .080	10:1 Comp. 2500 2501 2502 2503 2504	4606M08550 4606M08550 4606M08600 4606M08700	8604DA 8604D050 8604D100 8604D200	VT23162 VT23162050 VT23162100	379165				Top End C7825-EST (SS Head) C7924-EST (87mm)	Top End 35-1496 Complete w/oil seals 37-1829 (89-04) 37-1894 (05-09)		Intake 28-14952 Exhaust 28-14951 Set 28-1495S Valve Springs 30-3111	Valve Guide IN / EX 30-3120 O/S +.001 30-3121	Hot Cams Camshaft 1007-1 (Stage 1) 1043-2 (Stage 2) 1051-3 (Stage 3)	CC-1496	Hot Rods HR4040	Hot Rods HR8609	Bearing / Seal Kit 49K014		49-822278
TRX-400EX Big Bore to 425cc, 435cc 88mm 89mm	1999-14	BB	H-5445	88.00 88.00 89.00 89.00	.120 .120 .160 .160		4606M08800 4628M08800 4667M08900	8702DA 8702D050 8702D100 8702D200	VT23234200	199656				Top End C7826-EST (SS Head)			Intake 28-14952 Exhaust 28-14951 Set 28-1495S Valve Springs 30-3111	Valve Guide IN / EX 30-3120 O/S +.001 30-3121	Hot Cams Camshaft 1007-1 (Stage 1) 1043-2 (Stage 2)	CC-1496	HR4040	HR8609	Bearing / Seal Kit 49K014		

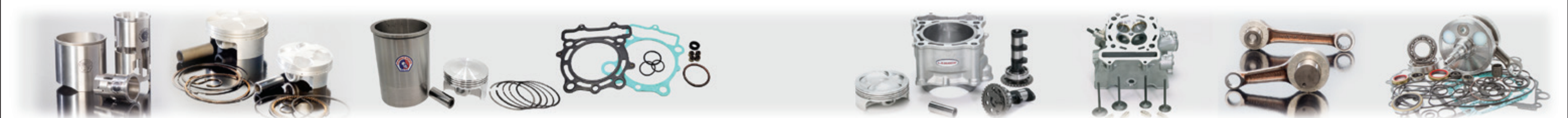

ATV-UTV ARCTIC CAT
ATV-UTV BOMBARDIER
ATV-UTV HONDA
ATV-UTV KAWASAKI
ATV-UTV KTM/KYMCO
ATV-UTV POLARIS
ATV-UTV SUZUKI
ATV-UTV YAMAHA
PERSONAL WATERCRAFT



MODEL
Engine Description
Cylinder I.D. (mm/in.)



SLEEVE

REBUILD KIT
Sleeve, Piston
Gasket, T.E. Bearing

BORE SIZE (mm)

PISTON SIZE

TOP END

TOP END

VALVE TRAIN

BOTTOM END

PRO-X PISTON

LAPC PISTON

WISECO PISTON

WOSSNER PISTON

VERTEX PISTON

JE PISTON

COMETIC GASKET

L.A. SLEEVE GASKET

CYLINDER AFTERMARKET KITS

VALVE / SPRING KIT

VALVE GUIDE

CAMSHAFT

CAM CHAIN

CRANKSHAFT

CON-ROD KIT

CRANK BEARING

ENGINE OIL SEAL KIT

HONDA ATV-UTV FOUR-STROKE (CONTINUED)

MODEL	Year	Configuration	Stock Comp.	Stock Comp.	Stock Comp.	9.9:1 Comp.	9.9:1 Comp.	Top End	Top End	Cylinder Works	Intake	Valve Guide	Hot Cams	CC	Hot Rods	Hot Rods	Bearing / Seal Kit				
FourTrax 400 Rancher AT 397cc Single 85mm 3.346"	2004-07	RS H-5630	5630K	85.00 Std. 85.50 .020 86.00 .040				Top End 35-0902						CC-1480							
FourTrax 420 Rancher AT 420 420cc Single Liquid Cooled 86.5mm 3.406"	2007-13 2009-24	CI H-5497	5497K (09-24)	86.50 Std. 87.00 .020 87.50 .040 88.00 .060 88.50 .080	Stock Comp. 01.1487.000 01.1487.050 01.1487.100 01.1487.150 01.1487.200	Stock Comp. 65.1872A 65.1872.050 65.1872.100	Stock Comp. 40050M08650 40050M08700 40050M08750 40050M08800 40050M08850	9.9:1 Comp. 8869DA 8869D050 8869D100 8869D150 8869D200	9.9:1 Comp. VT24259 VT24259050					CC-1487			Bearing / Seal Kit 49K086				
TRX-450ES, S Foreman 433cc Single 90mm 3.543"	1998-04	RS H-5365	5365K	90.00 Std. 90.50 .020 91.00 .040 91.50 .060 92.00 .080	9:1 Comp. 01.1498.000 01.1498.050 01.1498.100 01.1498.200	9:1 Comp. 2670 2672 2674	9.5:1 Comp. 4825M09000 4825M09050 4825M09100 4825M09150 4825M09200							CC-1485				49-822209			
TRX-450R 450cc Liquid Cooled 94mm 3.700"	2004-05	AC H-5561	5561K	94.00 Std. 94.01 Std. 96.00 .080	10.5:1 Comp. 2600A 2600B		10.5:1 Comp. 4848M09400 4848M09600	10.5:1 Comp. 8609DA 8609DB	10.5:1 Comp. VT23163A VT23163B	11.5:1 Comp. 221771	Top End C7877-EST (94mm)	Top End 35-1494	Cylinder Works 10003 (Std. 94mm)	Intake 30-30750 Exhaust 30-30753 Valve Springs 30-30720	Valve Guide Intake 30-30730 Exhaust 30-30740	Hot Cams Camshaft 1016-1 (Stage 1) 1024-2 (Stage 2) 1056-3 (Stage 3)	CC-1494	Hot Rods HR4060 Hot Rods HR8632	Bearing / Seal Kit 49K046	49-822237	
TRX-450R to 480cc 97mm 479cc 98mm 489cc 99mm 499cc		BB H-5561B		97.00 .120 98.00 .160 99.00 .200			10.5:1 Comp. 8610DA	10.5:1 Comp. VT23531A	12:1 Comp. 221834		Top End C7199-EST (95mm) C7878-EST (96mm) C7201-EST (97mm) C3079-EST (100mm) C3076-EST (101mm)	Complete w/oil seals 37-1494	Cylinder Works Complete Kit 10003-K01 (Std. 94mm) Big Bore Complete Kit 11003-K01 (479cc, 97mm)				Hot Rods Bottom End Kit CBK0097 Includes Crankshaft, Bearings, Seals, Complete Gasket Set				
TRX-450R 450cc Liquid Cooled 96mm 3.780"	2006-09 2006-14	AC H-5537	5537K-1	96.00 Std. 98.00 .080	12:1 Comp. 01.1496A		12:1 Comp. 4899M09600	12:1 Comp. 8660DA 8660D200	12:1 Comp. VT23522A	13:1 Comp. 274189 274615	Top End C3139-EST (96mm) C3141-EST (98mm)	Top End 35-1497	Cylinder Works Plated Bore 10005 (Std. 96mm) Cylinder Works Complete Kit 10005-K01 (Std. 96mm)	Intake 30-30950 Exhaust 30-30953 Valve Springs 30-30920	Valve Guide Intake 30-30930 O/S +.001 30-30931 Exhaust 30-30940 O/S +.001 30-30941	Hot Cams Camshaft (06-07) 1016-1 (Stage 1) 1024-2 (Stage 2) (08-14) 1105-1 (Stage 1) 1106-2 (Stage 2)	CC-1403	Hot Rods HR4070 Hot Rods HR8660 Pro-X 03.1405	Bearing / Seal Kit 49K047	49-822312	
TRX-450R, ER Big Bore to 477cc 99mm	2006-14	BB H-5537B		99.00 .120					12:1 Comp. VT23523A	12.5:1 Comp. 325026	Top End C3272-EST (99mm) C3156-EST (101mm)		Complete Kit 11005-K01 (477cc, 99mm)				Complete Head Service Kit 30-33360 Includes Std. Valves, Guides, Spring Kit, Seals, Gaskets				13:1 Comp. 247615
REPAIR SLEEVE FOR ATHENA 490CC BIG BORE CYLINDER REDUCES BORE TO 98MM-99MM CYLINDER WORKS CYLINDER KITS INCLUDE CYLINDER, PISTON KIT AND GASKETS		AC H-5581		98.00 .080																	

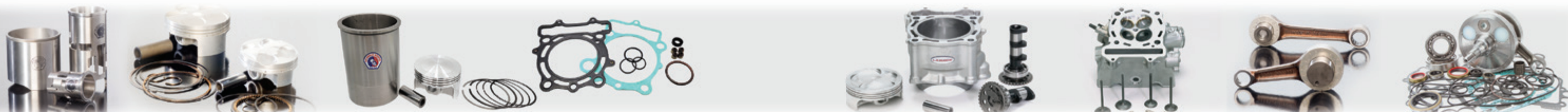

ATV-UTV ARCTIC CAT
ATV-UTV BOMBARDIER
ATV-UTV HONDA
ATV-UTV KAWASAKI
ATV-UTV KTM/KYMCO
ATV-UTV POLARIS
ATV-UTV SUZUKI
ATV-UTV YAMAHA
PERSONAL WATERCRAFT



MODEL
Engine Description
Cylinder I.D. (mm/in.)



SLEEVE

REBUILD KIT
Sleeve - Piston
Gasket - T.E. Bearing

BORE SIZE (mm)

PISTON SIZE

TOP END

TOP END

VALVE TRAIN

BOTTOM END

PRO-X PISTON

LAPC PISTON

WISECO PISTON

WOSSNER PISTON

VERTEX PISTON

JE PISTON

COMETIC GASKET

L.A. SLEEVE GASKET

CYLINDER AFTERMARKET KITS

VALVE / SPRING KIT

VALVE GUIDE

CAMSHAFT

CAM CHAIN

CRANKSHAFT

CON-ROD KIT

CRANK BEARING

ENGINE OIL SEAL KIT

HONDA ATV-UTV FOUR-STROKE (CONTINUED)

MODEL	RS	H	5591K	92.00	Std.	9.2:1 Comp.	8.5:1 Comp.	8.5:1 Comp.	8.5:1 Comp.	8.5:1 Comp.	Top End	(IN / EX Set)	Hot Rods	Hot Rods	49-822276		
TRX-500 FE, FM 2005-11 FourTrax Foreman 4x4 475cc Single Air Cooled 92mm 3.622"	RS	H-5591	5591K	92.00 92.50 93.00 93.50	.020 .040 .060	01.1501.000 01.1501.050 01.1501.100	65.1871A 65.1871.050 65.1871.100	8902DA 8902D050 8902D100 8902D150	VT24261 VT24261050 VT24261100	Top End 35-0896 Complete w/oil seals 37-1896 (FE, FPE)	(IN / EX Set) 07-031 X2	Hot Rods HR4410	Hot Rods HR8699	Bearing / Seal Kit 49K079	49-822276		
TRX-500 FE, FM, FA 2012-19 FourTrax Foreman 4x4 Foreman Rubicon 475cc Single Liquid Cooled 92mm 3.622"	CS	H-5767		92.00 92.50 93.00	Std. .020 .040		9.5:1 Comp. 65.1873A 65.1873.050 65.1873.100	10:1 Comp. 40174M09200 40174M09250	9.5:1 Comp. VT24260 VT24260050 VT24260100	Top End 35-0999 Complete w/seals 37-0024 (FE, FPE)				Bearing / Seal Kit 49K086	49-822351		
Pioneer 500 SXS 2015-23 475cc Single Liquid Cooled 92mm 3.622"	CS	H-5767		92.00 92.50 93.00	Std. .020 .040		9.5:1 Comp. 65.1873A 65.1873.050 65.1873.100	10:1 Comp. 40174M09200 40174M09250	9.5:1 Comp. VT24260 VT24260050 VT24260100	Top End 35-0999				Bearing / Seal Kit 49K086	49-822351		
TRX-500FA 2002-14 FourTrax Foreman Rubicon 499cc Single Liquid Cooled 92mm 3.622"	CS	H-5504	5504K	92.00 92.50 93.00 93.50	Std. .020 .040 .060	9.2:1 Comp. 01.1501.000 01.1501.050 01.1501.100		8.3:1 Comp. 40173M09200 40172M09250	8.5:1 Comp. 8902DA 8902D050 8902D100 8902D150	Top End 35-0843 Complete w/oil seals 37-1843	(IN / EX Set) 07-025 X2		CC-1501		49-822210		
TRX-520 FA 2020-24 FourTrax Foreman 4x4 Foreman Rubicon 518cc Single Liquid Cooled 96mm 3.780"	AC	H-5812		96.00	Std.			Stock Comp. 40287M09600									
Pioneer 520 SXS 2022-23 518cc Single Liquid Cooled 96mm 3.780"	AC	H-5812		96.00	Std.			Stock Comp. 40287M09600									
FourTrax Rincon 2003-05 649cc Single 100mm 3.937"	AC	H-5505		100.00	Std.			11:1 Comp. 40067M10000				(IN / EX Set) 07-027 X2		CC-1603			
FourTrax Rincon 680 2006-23 Big Red MUV 2009-13 Pioneer 700 SXS 2014-24 675cc Single Liquid Cooled 102mm 4.015"	CI	H-5621		102.00 102.50 103.00	Std. .020 .040	9.2:1 Comp. 01.1714.000 01.1714.050 01.1714.100		10:1 Comp. 40066M10200 40066M10300	9.2:1 Comp. VT24484 VT24484050	Top End C3475-EST (Rincon)	(IN / EX Set) 07-027 X2		CC-1603				
TRX-700XX 2008-12 686cc Single Liquid Cooled 102mm 4.015" <i>CYLINDER WORKS CYLINDER KITS INCLUDE CYLINDER, PISTON KIT AND GASKETS</i>	CI	H-5689		102.00 103.00 104.00	Std. .040 .080	10:1 Comp. 01.1708.000 01.1708.100		10.5:1 Comp. 40075M10200 40075M01300 40075M10400	10.1:1 Comp. VT23638A	Top End C3420-EST C3286-EST (104mm)	Top End 35-0021	Cylinder Works 10009 (Std. 102mm) Cylinder Works Complete Kit 10009-K01 (Std. 102mm)	Intake 30-31362 Exhaust 30-31366 Valve Springs 30-31350	Valve Guide Intake 30-31370 O/S +.001 30-31371 Exhaust 30-31380 O/S +.001 30-31381	Hot Cams Camshaft (08-09) 1134-1 (Stage 1) 1135-2 (Stage) 1136-3 (Stage 3)	CC-2419	Bearing / Seal Kit 49K060
Pioneer 1000 SXS 2016-24 1000cc Twin Liquid Cooled 92mm 3.622"	CI	H-5800		92.00 92.50	Std. .020				10:1 Comp. VT24486 VT24486050								
Talon 1000R SXS 2019-23 1000cc Twin Liquid Cooled 92mm 3.622"	CI	H-5800		92.00 92.50	Std. .020				10:1 Comp. VT24485 VT24485050								

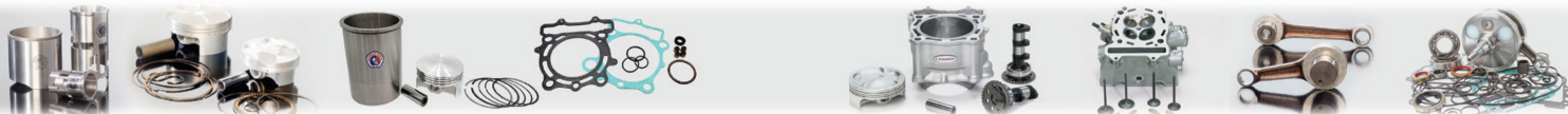

ATV-UTV ARCTIC CAT
ATV-UTV BOMBARDIER
ATV-UTV HONDA
ATV-UTV KAWASAKI
ATV-UTV KTM/KYMCO
ATV-UTV POLARIS
ATV-UTV SUZUKI
ATV-UTV YAMAHA
PERSONAL WATERCRAFT



MODEL
Engine Description
Cylinder I.D. (mm/in.)



SLEEVE

REBUILD KIT
Sleeve - Piston
Gasket - T.E. Bearing

BORE SIZE (mm)

PISTON SIZE

TOP END

TOP END

BOTTOM END

PRO-X PISTON

LAPC PISTON

WISECO PISTON

WOSSNER PISTON

VERTEX PISTON

T.E. BEARING

COMETIC GASKET

L.A. SLEEVE GASKET

CRANKSHAFT

CON-ROD KIT

CON-ROD ASSEMBLY
Rod - Bearings - Seals

CRANK BEARING

CRANK SEAL KIT

KAWASAKI ATV-UTV TWO-STROKE

MODEL	Year	CC	FL	BORE	STROKE	PRO-X PISTON	LAPC PISTON	WISECO PISTON	WOSSNER PISTON	VERTEX PISTON	T.E. BEARING	COMETIC GASKET	L.A. SLEEVE GASKET	CRANKSHAFT	CON-ROD KIT	CON-ROD ASSEMBLY	CRANK BEARING	CRANK SEAL KIT
KFX-50 49cc 41MM	2003-06	CC	FL-5492	41.00 41.50 42.00 42.50 43.00	Std. .020 .040 .060 .080	01.3001 01.3001.100 01.3001.150		826M04100 826M04150 826M04200 826M04300			T.E. Bearing B1000		Top End 35-0850					
KFX-80 82cc 50mm	2003-06	RS/L	FL-5369	50.00 50.25 50.50 51.00 51.50 52.00	Std. .010 .020 .040 .060 .080	5210 5212 5214 5216		673M05000 673M05025 673M05050 673M05100 673M05150 673M05200	8282DA 8282D050 8282D100 8282D150 8282D200		T.E. Bearing 01215	Top End C7229	Top End 35-0849 Complete w/oil seals 37-1849		Pro-X 04932	39-4932	6204C3 Bearing / Seal Kit 494397	094397
KXT-250 Tecate 249cc 70mm	1984-85	AC/MO	KA-795	70.00 70.50 71.00	Std. .020 .040	Liquid Cooled		439M07000 439M07050 439M07100			T.E. Bearing 01337	Top End C7049	Complete w/oil seals 37-1818		Pro-X 04967 Hot Rods HR8108	39-6305	6305C3 Bearing / Seal Kit 496305	094488
KXT-250 Tecate KIPS 249cc 70mm	1986-87	AC/MO	KA-949	70.00 70.50 71.00	Std. .020 .040	Liquid Cooled		439M07000 439M07050 439M07100			T.E. Bearing 01337	Top End C7038	Complete w/oil seals 37-1819		Pro-X 04967 Hot Rods HR8108	39-6305	6305C3 Bearing / Seal Kit 496305	094488
KFX-250 Tecate 4 249cc 67.4mm	1987-88	AC	KA-5007	67.40 68.50 69.50	Std. .045 .084	Liquid Cooled		556M06740 556M06850 556M06950			T.E. Bearing 01337	Top End C7039	Complete w/oil seals 37-1820		Pro-X 04967 Hot Rods HR8108	39-4961	6328C3 Bearing / Seal Kit 494488	094491
KXF-250 to 295cc Big Bore Tecate 4 73mm <i>(HEAD MODIFICATION REQUIRED)</i>	1987-88	BB/MO	KA-5007B	73.00 74.00 69.50	Std. .040 .084				W5007PS W5007P4 <i>Limited to Available Stock</i>		T.E. Bearing 01337	Top End GS5007			Pro-X 04967 Hot Rods HR8108	39-4961	6328C3 Bearing / Seal Kit 494488	094491

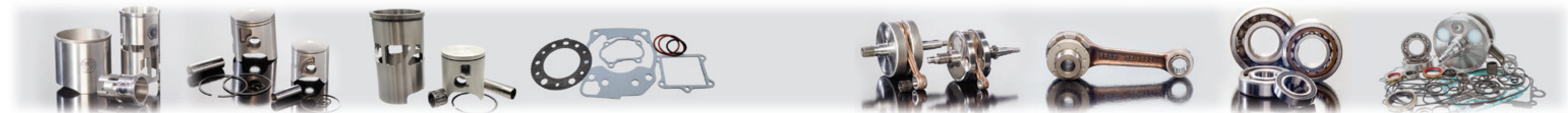

ATV-UTV ARCTIC CAT
ATV-UTV BOMBARDIER
ATV-UTV HONDA
ATV-UTV KAWASAKI
ATV-UTV KTM/KYMCO
ATV-UTV POLARIS
ATV-UTV SUZUKI
ATV-UTV YAMAHA
PERSONAL WATERCRAFT



MODEL
Engine Description
Cylinder I.D. (mm/in.)



SLEEVE

REBUILD KIT
Sleeve • Piston
Gasket • T.E. Bearing

BORE SIZE
(mm)

PISTON SIZE

TOP END

TOP END

VALVE TRAIN

BOTTOM END

PRO-X PISTON

LAPC PISTON

WISECO PISTON

WOSSNER PISTON

VERTEX PISTON

JE PISTON

COMETIC GASKET

L.A. SLEEVE GASKET

CYLINDER AFTERMARKET KITS

VALVE / SPRING KIT

VALVE GUIDE

CAMSHAFT

CAM CHAIN

CRANKSHAFT

CON-ROD KIT

CRANK BEARING

ENGINE OIL SEAL KIT

KAWASAKI ATV-UTV FOUR-STROKE (CONTINUED)

MODEL	Year	AC	FL	5430K	90.00	Std.	12.25:1 Comp.	12.25:1 Comp.	12.25:1 Comp.	11.3:1 Comp.	12:1 Comp.	Top End	Top End	Cylinder Works	Intake	Valve Guide	Hot Cams	CC-3403	HR4059	Pro-X	6306RI	49-822201
KFX-400 398cc Liquid Cooled 90mm 3.543" <i>RESLEEVEING REQUIRED FOR OVERSIZES</i> <i>CYLINDER WORKS COMPLETE KIT INCLUDES CYLINDER, PISTON KIT, GASKETS</i>	2003-06	AC	FL-5430	5430K	90.00	Std.	5220A	4713M09000	8563DA	VT22951A	180297	Top End C7978-EST (92mm)	Top End 35-3402 (90mm)	Cylinder Works 40001 (Std. 90mm)	28-34022	IN / EX 60-60060	2249-11N (Intake)	CC-3403	HR4059	Pro-X 04921	6306RI	49-822201
					91.00	.040	5220B	8563DB	VT22951B	28-34021	60-60060				2250-1E (Exhaust)	Hot Rods HR8630	Bearing / Seal Kit 494488					
KFX-400 Big Bore 434cc to 450cc 94mm 3.700" 434cc 94.00mm 440cc 94.50mm 443cc 95.00mm 450cc 95.50mm <i>COMPLETE CYLINDER KIT INCLUDES BIG BORE CYLINDER, PISTON KIT, AND TOP END GASKET KIT. PISTON KIT, GASKETS</i>	2003-06	BB	FL-5430B	5430K	94.00	.160		12.5:1 Comp.	12.2:1 Comp.	11.5:1 Comp.	12:1 Comp.	Top End C7979-EST (94mm)	Top End 37-3402	Cylinder Works Complete Kit 40001-K01 (Std. 90mm)	28-34022	IN / EX 60-60060	2249-11N (Intake)	CC-3403	HR4059	Pro-X 04921	6306RI	49-822201
					95.00	.200		8563D400	VT23533	183051	28-34021				60-60060	2250-1E (Exhaust)	Hot Rods HR8630			Bearing / Seal Kit 49K049		
					95.50	.220		8563D550	VT23533	243651	28-3402S				60-60061	2250-1E (Exhaust)	Hot Rods HR8630			Bearing / Seal Kit 49K049		
KFX-450R 449cc Liquid Cooled 96mm 3.780" <i>RESLEEVEING REQUIRED FOR OVERSIZES</i>	2008-14	AC	KA-5675	5675K	96.00	Std.	12.5:1 comp.	12.4:1 Comp.	12.5:1 Comp.	12.4:1 Comp.	12.8:1 Comp.	Top End C3201-EST (96mm)	Top End 35-0920	Cylinder Works Complete Kit 41001-K01 (434cc, 94mm)	40-40562	IN / EX 40-40570	2093-21N (Intake)	CC-2706	HR4086	Hot Rods HR8671	49-822334	49-822334
					96.01	Std.	4418A	4973M09600	8773DA	VT23543A	40-40566				40-40571	2093-21N (Intake)	Stroker +3mm HR4186 (470cc)			Bearing / Seal Kit 49K056		
					96.00	.080	4418B	8773DB	VT23543B	261971	28-44061				40-40550	2094-2E (Exhaust)	Hot Rods Bottom End Kit CBK0121 <i>Includes Crankshaft, Bearings Seals, Complete Gasket Set</i>					
KFX-450R	2008-14	AC	KA-5675	5675K	96.00	Std.		13.4:1 Comp.		13.4:1 Comp.	13.5:1 Comp.	Top End C3202-EST (98mm)	Complete w/oil seals 37-1920	Cylinder Works Complete Kit 41001-K01 (434cc, 94mm)	40-40566	O/S +.001 40-40571	2095-31N (Intake)	CC-2706	HR4086	Hot Rods HR8671	49-822334	49-822334
					98.00	.080		8773DB	VT23543B	261972	28-44061				40-40550	2096-3E (Exhaust)	Hot Rods Bottom End Kit CBK0121 <i>Includes Crankshaft, Bearings Seals, Complete Gasket Set</i>					
KFX-450R	2008-14	AC	KA-5675	5675K	96.00	Std.		14:1 Comp.		13.8:1 Comp.	13.8:1 Comp.	Top End GS5430 (97mm)	Complete w/oil seals 37-1920	Cylinder Works Complete Kit 41001-K01 (434cc, 94mm)	40-40566	O/S +.001 40-40571	2095-31N (Intake)	CC-2706	HR4086	Hot Rods HR8671	49-822334	49-822334
					96.00	.080		8709DA (Pro Series)	VT23544A	261970 (Pro Series)	28-44061				40-40550	2096-3E (Exhaust)	Hot Rods Bottom End Kit CBK0121 <i>Includes Crankshaft, Bearings Seals, Complete Gasket Set</i>					

ATV-UTV
ARCTIC CAT

ATV-UTV
BOMBARDIER

ATV-UTV
HONDA

ATV-UTV
KAWASAKI

ATV-UTV
KTM/KYMCO

ATV-UTV
POLARIS

ATV-UTV
SUZUKI

ATV-UTV
YAMAHA

PERSONAL
WATERCRAFT

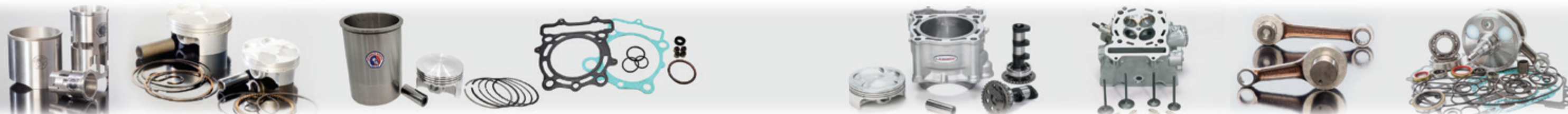



MODEL
Engine Description
Cylinder I.D. (mm/in.)



SLEEVE

REBUILD KIT
Sleeve • Piston
Gasket • T.E. Bearing

BORE SIZE (mm)

PISTON SIZE

TOP END

TOP END

VALVE TRAIN

BOTTOM END

PRO-X PISTON

LAPC PISTON

WISECO PISTON

WOSSNER PISTON

VERTEX PISTON

JE PISTON

COMETIC GASKET

L.A. SLEEVE GASKET

CYLINDER AFTERMARKET KITS

VALVE / SPRING KIT

VALVE GUIDE

CAMSHAFT

CAM CHAIN

CRANKSHAFT

CON-ROD KIT

CRANK BEARING

ENGINE OIL SEAL KIT

KAWASAKI ATV-UTV FOUR-STROKE (CONTINUED)

KVF-650 Prairie Brute Force 2002-10 2002-03 2005-10 633cc Liquid Cooled V-Twin 80mm 3.150"	RS	KA-5508	80.00 80.50 81.00 81.50 82.00	Std. .020 .040 .060 .080				11:1 Comp. 4782M08000 4782M08050 4782M08100 4782M08200	11:1 Comp. 8663DA 8663D050 8663D100 8663D150 8663D200				Top End C7981-EST C7982-EST (83mm)	Top End 35-0879 Complete w/oil seals 37-1879	Intake 40-40412 Exhaust 40-40416	Valve Guide IN / EX 40-40420 O/S +.001 40-40421	Hot Cams Camshaft 2036-1S					49-822251	
KVF-650 Prairie Big Bore to 750cc 2002-10 87mm 3.425"	BB	KA-5526B	87.00	.275									11:1 Comp. 221786	Top End GS5526			Hot Cams Camshaft 2036-1S						
Brute Force 650 4x4i 2005-16 633cc Liquid Cooled V-Twin 80mm 3.150"	AC	KA-5676	80.00	Std.				11:1 Comp. 4782M08000	11:1 Comp. 8663DA				Top End C7981-EST	Top End 35-0879 35-0953 (4x4i) Complete w/oil seals 37-1879 37-1953 (4x4i)	Intake 40-40412 Exhaust 40-40416 Valve Springs 40-40400	Valve Guide IN / EX 40-40420 O/S +.001 40-40421	Hot Cams Camshaft 2036-1S (06-11)					49-822251	
KFX-700 Prairie 700 2004-10 2004-06 697cc Liquid Cooled Twin 82mm 3.228"	RS	KA-5526	82.00 82.50 83.00 83.50 84.00	Std. .020 .040 .060 .080				11.5:1 Comp. 4896M08200 4896M08400	11.3:1 Comp. 8697DA 8697D050 8697D100 8697D150 8697D200	9.9:1 Comp. VT24488 VT24488050			Top End C7982-EST (83mm) C3125-EST (84mm)	Top End 35-0880 Complete w/oil seals 37-1880	Intake 40-40412 Exhaust 40-40416 Valve Springs 40-40400	Valve Guide IN / EX 40-40420 O/S +.001 40-40421	Hot Cams Camshaft 2036-1S	KFX CC-4705 46L (1 req.) CC-4706 92L (2 req.)	HR4089	Hot Rods HR8675 Rod Bolts HR00091		49-822251	
KFX-700 Prairie 700 Big Bore to 749cc, 784cc 2004-10 2004-06 85mm 3.346" 749cc 87mm 3.425" 797cc	BB	KA-5526B	85.00 87.00	.120 .275					11.3:1 Comp. 8697D300				11:1 Comp. 221786	Top End GS5526									
Mule Pro 700 2019-22 695cc Single Liquid Cooled 102mm 4.015"	AC	FL-5595																					

Hot Rods Bottom End Kit
CBK0177
Includes Crankshaft, Bearings
Seals, Complete Gasket Set

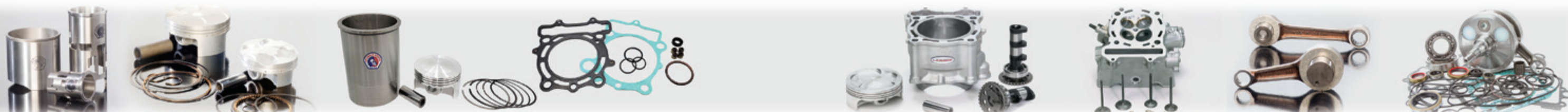

ATV-UTV ARCTIC CAT
ATV-UTV BOMBARDIER
ATV-UTV HONDA
ATV-UTV KAWASAKI
ATV-UTV KTM/KYMCO
ATV-UTV POLARIS
ATV-UTV SUZUKI
ATV-UTV YAMAHA
PERSONAL WATERCRAFT



MODEL
Engine Description
Cylinder I.D. (mm/in.)

SLEEVE

REBUILD KIT
Sleeve - Piston
Gasket - T.E. Bearing

BORE SIZE (mm)

PISTON SIZE

TOP END

TOP END

VALVE TRAIN

BOTTOM END

PRO-X PISTON

LAPC PISTON

WISECO PISTON

WOSSNER PISTON

VERTEX PISTON

JE PISTON

COMETIC GASKET

L.A. SLEEVE GASKET

CYLINDER AFTERMARKET KITS

VALVE / SPRING KIT

VALVE GUIDE

CAMSHAFT

CAM CHAIN

CRANKSHAFT

CON-ROD KIT

CRANK BEARING

ENGINE OIL SEAL KIT

KAWASAKI ATV-UTV FOUR-STROKE (CONTINUED)

MODEL	Engine Description	Cylinder I.D. (mm/in.)	SLEEVE	REBUILD KIT	BORE SIZE (mm)	PISTON SIZE	PRO-X PISTON	LAPC PISTON	WISECO PISTON	WOSSNER PISTON	VERTEX PISTON	JE PISTON	COMETIC GASKET	L.A. SLEEVE GASKET	CYLINDER AFTERMARKET KITS	VALVE / SPRING KIT	VALVE GUIDE	CAMSHAFT	CAM CHAIN	CRANKSHAFT	CON-ROD KIT	CRANK BEARING	ENGINE OIL SEAL KIT															
Brute Force 750 Teryx 750 4x4 749cc Liquid Cooled V-Twin 85mm 3.346"	2005-23 2008-13	AC KA-5592	85.00 85.01 87.00	Std. Std. .080	8.8:1 Comp. 4705A 4705B	(05-11) 4897M08500	(05-11) 4897M08700	(05-14) VT23908A VT23908B	(05-11) 274191 (Set of 2)	Top End C3284-EST	Top End 35-0881 (05-12)	Cylinder Works Front Cyl. 30007 Rear Cyl. 30008 (Std. 85mm)	(05-12) Intake 40-40412 Exhaust 40-40416 Valve Springs 40-40400	Valve Guide IN / EX 40-40420	Hot Cams Camshaft 2036-1S (Stage 1)	CC-4705 46L (1 req.) CC-4706 92L (2 req.)	Hot Rods HR4089 (05-11)	Hot Rods HR8675 (2 req.)	CC-4705 46L (1 req.) CC-4706 92L (2 req.)	Hot Rods HR4412 750 4x4i (12-20) Teryx 4x4 (13)	Rod Bolts HR00091	49-822251 (05-11)	49-822366 (12-14)	49-822881 (15-21)														
																									RESLEEVEING REQUIRED FOR OVERSIZES	CYLINDER WORKS COMPLETE KIT INCLUDES CYLINDERS (2), PISTON KITS (2), GASKETS	85.00 85.01 87.00	Std. Std. .080	40146M08500 (12-14)	40146M08700	11.5:1 Comp. VT23909A VT23909B	(12-20) 317182 (Set of 2)	Complete w/oil seals 37-1881 (05-12)	Cylinder Works Complete Kit Front/Rear Cyl. 30007-K03 (05-14) (Std. 85mm)	(13-18) 750 4x4i Intake 40-40920 Exhaust 40-40924	(13-18) 750 4x4i IN / EX 40-40910	Hot Rods Bottom End Kit CBK0178 (05-11)	Main Bearing / Seal Kit 49K075
Brute Force 750 Teryx 750 4x4 Big Bore to 840cc 90mm 3.543"	2005-23 2008-13	BB KA-5592B	90.00	.200				11.5:1 Comp. 274192 (Set of 2)	Top End C3251-EST																													
KRF Teryx 800 4x4 KRT Teryx 4 800 4x4 784cc V-Twin Liquid Cooled 85mm 3.346"	2014-24 2014-24	AC KA-5781	85.00	Std.					10.7:1 Comp. VT24487B			Top End 35-0038	Cylinder Works Front Cyl. 30013 Rear Cyl. 30014 (Std. 85mm)	Intake 40-40920 Exhaust 40-40924	Valve Guide IN / EX 40-40910								49-822396															
KRX Teryx 1000 1000cc Twin Liquid Cooled 92mm 3.622"	2020-24	AC KA-5813	92.00 92.01	Std. Std.		11.5:1 Comp. 40269M09200			11.5:1 Comp. VT24502A VT24502B			Top End 35-0040	Cylinder Works 30015 (Std. 92mm)																									
<p>RESLEEVEING REQUIRED FOR OVERSIZES</p> <p>CYLINDER WORKS COMPLETE KIT INCLUDES CYLINDERS (2), PISTON KITS (2), GASKETS</p> <p>CYLINDER WORKS COMPLETE KIT INCLUDES CYLINDER, PISTONS KITS (2), GASKET KIT.</p>																																						

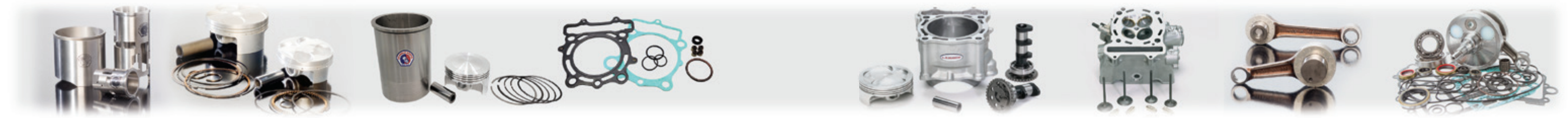

ATV-UTV ARCTIC CAT
ATV-UTV BOMBARDIER
ATV-UTV HONDA
ATV-UTV KAWASAKI
ATV-UTV KTM/KYMCO
ATV-UTV POLARIS
ATV-UTV SUZUKI
ATV-UTV YAMAHA
PERSONAL WATERCRAFT



MODEL
Engine Description
Cylinder I.D. (mm/in.)



SLEEVE

REBUILD KIT
Sleeve • Piston
Gasket • T.E. Bearing

BORE SIZE (mm)

PISTON SIZE

TOP END

TOP END

VALVE TRAIN

BOTTOM END

PRO-X PISTON

LAPC PISTON

WISECO PISTON

WOSSNER PISTON

VERTEX PISTON

JE PISTON

COMETIC GASKET

L.A. SLEEVE GASKET

CYLINDER AFTERMARKET KITS

VALVE / SPRING KIT

VALVE GUIDE

CAMSHAFT

CAM CHAIN

CRANKSHAFT

CON-ROD KIT

CRANK BEARING

ENGINE OIL SEAL KIT

KTM ATV-UTV FOUR-STROKE

450 XC 2008-12 448cc Liquid Cooled 89mm 3.504"	AC	FL-5442		89.00 89.01 89.00	Std. Std. Std.	11:1 Comp. 6413A 6413B		11:1 Comp. 4941M08900 12:1 Comp. 4942M08900	11:1 comp. 8581DA	11:1 Comp. VT23329A 12:1 Comp. VT23340A	12.5:1 Comp. 274221 13:1 Comp. 274219		Top End C3263-EST C3264-EST (91mm)	Top End 35-0317		Intake 28-65202 Exhaust 28-65201 Valve Springs 96-96000				Pro-X 04925 (08-09)	NJ206 Bearing / Seal Kit CBS64003	
450 SX 2009-11 449cc Liquid Cooled 97mm 3.818"	AC	FL-5638	5638K	89.00 97.00 97.01 97.00	Std. Std. Std.	12.5:1 Comp. 6427A 6427B		12.5:1 Comp. 4937M09700	12.5:1 Comp. 8665DA 8665DB	12.5:1 Comp. VT23342A VT23342B	12.5:1 Comp. 260955 13:1 Comp. 260956		Top End C3412-EST	Top End 35-0331		Intake Titanium 28-64272 Exhaust Titanium 28-64271			CC-6427	Pro-X 03.6427	NJ206 Bearing / Seal Kit CBS64007	49-822342
505 SX 2009-12 477cc Liquid Cooled 100mm 3.937"	AC	FL-5584		100.00 100.01 100.00	Std. Std. Std.	12.5:1 Comp. 6508A 6508B		12.5:1 Comp. 4947M10000 13.5:1 Comp. 4948M10000	12.5:1 Comp. 8705DA 8725DA	12.5:1 Comp. VT23417A			Top End C3413-EST	Top End 35-0942		Intake Titanium 28-64272 Exhaust Titanium 28-64271			CC-6427	Pro-X 03.6508	NJ206 Bearing / Seal Kit CBS64007	49-822342
525 XC 2008-12 510cc Liquid Cooled 95mm 3.740"	AC	FL-5437	5437K	95.00 97.00	Std. .080	11:1 Comp. 6520A		11:1 Comp. 4731M09500 4731M09700	11:1 Comp. 8547DA 8547D200	12.5:1 Comp. VT22969A	12.5:1 Comp. 274173		Top End C7944-EST (95mm) C7691-EST (97mm)	Top End 35-6528 Complete w/oil seals 37-6528		Intake 28-65202 Exhaust 28-65201 Valve Springs 96-96000	Valve Guides Intake 96-96010 O/S +.001 96-96011	Hot Cams Camshaft 3015-1		Pro-X 04925 Hot Rods HR8666	NJ206 Bearing / Seal Kit CBS64003	
525 XC 2008-12 Big Bore to 565cc 100mm 3.937"	BB	FL-5437B		100.00	.200								Top End GS5437 (100mm)									

KYMCO ATV-UTV FOUR-STROKE

MXU-250 2004-09 249cc Liquid Cooled 72.7mm 2.862"	AC	FL-5613																				
MXU-300 2009-15 Mongoose 300 2009-15 270cc Liquid Cooled 72.7mm 2.862"	AC	FL-5543																				
MXU-500 2008-17 UXV-500 2009-17 499cc Liquid Cooled 92mm 3.622"		FL-5392																				
MXU-700i 2014-23 UXV-700i 2014-23 695cc Single Liquid Cooled 102mm 4.016"	RS	FL-5787																				
MXU, UXV-700 2014-23 Big Bore to 740cc 105mm 4.134"	BB	FL-5787B																				

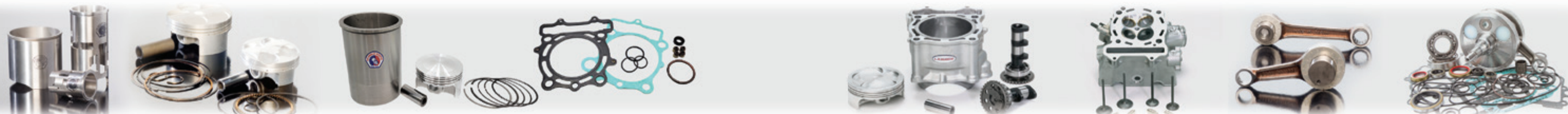

ATV-UTV ARCTIC CAT
ATV-UTV BOMBARDIER
ATV-UTV HONDA
ATV-UTV KAWASAKI
ATV-UTV KTM / KYMCO
ATV-UTV POLARIS
ATV-UTV SUZUKI
ATV-UTV YAMAHA
PERSONAL WATERCRAFT



MODEL
Engine Description
Cylinder I.D. (mm/in.)

SLEEVE

REBUILD KIT
Sleeve - Piston
Gasket - T.E. Bearing

BORE SIZE (mm)

PISTON SIZE

TOP END

TOP END

BOTTOM END

PRO-X PISTON

LAPC PISTON

WISECO PISTON

WOSSNER PISTON

VERTEX PISTON

T.E. BEARING

COMETIC GASKET

L.A. SLEEVE GASKET

CRANKSHAFT

CON-ROD KIT

CON-ROD ASSEMBLY
Rod - Bearings - Seals

CRANK BEARING

CRANK SEAL KIT

POLARIS ATV-UTV TWO-STROKE

MODEL	Year	Engine Description	Cylinder I.D. (mm/in.)	BORE SIZE (mm)	PISTON SIZE	PRO-X PISTON	LAPC PISTON	WISECO PISTON	WOSSNER PISTON	VERTEX PISTON	T.E. BEARING	COMETIC GASKET	L.A. SLEEVE GASKET	CRANKSHAFT	CON-ROD KIT	CON-ROD ASSEMBLY	CRANK BEARING	CRANK SEAL KIT		
Sportsman 90	2001-06	FL-5596		52.00	Std.			839M05200												
Scrambler 90	2001-05			52.50	.020			839M05250												
Predator 90	2001-06			53.00	.040			839M05300												
89cc	Single			53.50	.060			839M05350												
52mm	2.047"			43.00	.080			826M04300												
244	1985	CI FL-931	931K																	
244cc	Single			72.00	Std.			536M07200	8094DA											
72mm	2.834"			72.50	.020			536M07250	8094D050											
250 Trail Boss	1986-99	CI FL-5168	5168K					536M07300	8094D100											
Trail Blazer	1990-06			73.00	.040			536M07350	8094D150											
Xplorer 4x4	2000-02			73.50	.060			536M07400	8094D200											
244cc	Air Cooled			74.00	.080															
72mm	2.834"																			
300L	1994-99	CI FL-5273	5273K																	
Xplorer 300				74.50	Std.			721M07450	8095DA											
Xpress 300				75.00	.020			721M07500	8095D050											
283cc	Single			75.50	.040			721M07550	8095D100											
74.5mm	2.933"			76.00	.060			721M07600	8095D150											
				76.50	.080			721M07650	8095D200											
350L Trail Boss	1990-94	CI FL-5171																		
352cc	Liquid Cooled			80.00	Std.			639M08000	8096DA											
80mm	3.150"			80.50	.020			639M08050	8096D050											
				81.00	.040			639M08100	8096D100											
				81.50	.060			639M08150	8096D150											
				82.00	.080			639M08200	8096D200											
400L	1994-03	CI FL-5274	5274K																	
Xplorer 400,				83.00	Std.			675M08300	8097DA											
Scrambler 400				83.50	.020			675M08350	8097D050											
Sport 400, Trail Blazer				84.00	.040			675M08400	8097D100											
378cc	Liquid Cooled			84.50	.060			675M08450	8097D150											
83mm	3.268"			85.00	.080			675M08500	8097D200											



ATV-UTV ARCTIC CAT
ATV-UTV BOMBARDIER
ATV-UTV HONDA
ATV-UTV KAWASAKI
ATV-UTV KTM/KYMCO
ATV-UTV POLARIS
ATV-UTV SUZUKI
ATV-UTV YAMAHA
PERSONAL WATERCRAFT



MODEL
Engine Description
Cylinder I.D. (mm/in.)



SLEEVE

REBUILD KIT
Sleeve - Piston
Gasket - T.E. Bearing

BORE SIZE (mm)

PISTON SIZE

TOP END

TOP END

VALVE TRAIN

BOTTOM END

PRO-X PISTON

LAPC PISTON

WISECO PISTON

WOSSNER PISTON

VERTEX PISTON

JE PISTON

COMETIC GASKET

L.A. SLEEVE GASKET

CYLINDER AFTERMARKET KITS

VALVE / SPRING KIT

VALVE GUIDE

CAMSHAFT

CAM CHAIN

CRANKSHAFT

CON-ROD KIT

CRANK BEARING

ENGINE OIL SEAL KIT

POLARIS ATV-UTV FOUR-STROKE

MODEL	Engine Description	Cylinder I.D. (mm/in.)	SLEEVE	REBUILD KIT	BORE SIZE (mm)	PISTON SIZE	PRO-X PISTON	LAPC PISTON	WISECO PISTON	WOSSNER PISTON	VERTEX PISTON	JE PISTON	COMETIC GASKET	L.A. SLEEVE GASKET	CYLINDER AFTERMARKET KITS	VALVE / SPRING KIT	VALVE GUIDE	CAMSHAFT	CAM CHAIN	CRANKSHAFT	CON-ROD KIT	CRANK BEARING	ENGINE OIL SEAL KIT	
Phoenix 200	2005-24	CI	FL-5593																					
196cc	Single																							
65mm	2.562"																							
300 Hawkeye	2006-10	CI	FL-5623																					
300 Sportsman	2008-10																							
299cc	Single																							
78.5mm	3.090"																							
325 Trail Boss	2000-02	CI	FL-5367												Top End 35-0836									
325 Magnum	2000-02																							
325 Xpedition	2001-02																							
325cc	Single																							
78mm	3.070"																							
330 Magnum	2003-06	CI	FL-5509												Top End 35-0836									
330 Trail Boss	2003-13																							
330 Trail Blazer	2008-13																							
ATP 330	2005																							
329cc	Single																							
78.5mm	3.090"																							
ACE 325	2014-16	AC	FL-5791												Top End 35-0968									49-822375
Sportsman 325	2014-16																							
325cc	Single Liquid Cooled																							
78mm	3.070"																							
335 Sportsman 4x4	1999-00	CI	FL-5367												Top End 35-0837									
334cc	Single																							
78mm	3.070"																							
400 H.O. Sportsman	2008-14	CI	FL-5260												Top End 35-0821	Intake 82-82005 Exhaust 82-82008		Hot Cams Camshaft 5426-1 (Stage 1)		Hot Rods HR4438 (10-14)	Hot Rods HR8715 (08-14)	Bearing / Seal Kit HR00009 (10-14)		
400 Sportsman	2004-14														Complete w/oil seals 37-1821			5427-2 (Stage 2)						
400 Ranger	2010-13																							
455cc	Single Liquid Cooled																							
87.9mm	3.460"																							
425 Magnum	1995-98	CI	FL-5260												Top End C7311	Top End 35-0821	Intake 82-82005 Exhaust 82-82008							
425 Xpedition	2000-02																							
400 Sportsman 4x4	2001-05																							
425cc	Liquid Cooled																							
87.9mm	3.460"																							
450 H.O. Sportsman	2006-07	CI	FL-5260												Top End 35-0821	Intake 82-82005 Exhaust 82-82008		Hot Cams Camshaft 5426-1 (Stage 1)		Hot Rods HR8715				
455cc	Single Liquid Cooled																							
87.9mm	3.460"																							
450 H.O. Sportsman	2017-24	AC	FL-5826												Top End 35-24482						Hot Rods HR00027	Hot Rods HR8719		49-822141
499cc	Single Liquid Cooled																							
93mm	3.661"				93.00	Std.																		



ATV-UTV ARCTIC CAT
ATV-UTV BOMBARDIER
ATV-UTV HONDA
ATV-UTV KAWASAKI
ATV-UTV KTM/KYMCO
ATV-UTV POLARIS
ATV-UTV SUZUKI
ATV-UTV YAMAHA
PERSONAL WATERCRAFT



MODEL
Engine Description
Cylinder I.D. (mm/in.)



SLEEVE

REBUILD KIT
Sleeve, Piston
Gasket, T.E. Bearing

BORE SIZE
(mm)

PISTON SIZE

TOP END

TOP END

VALVE TRAIN

BOTTOM END

POLARIS ATV-UTV FOUR-STROKE (CONTINUED)

MODEL	AC	FL	BORE	STROKE	PRO-X PISTON	LAPC PISTON	WISECO PISTON	WOSSNER PISTON	VERTEX PISTON	JE PISTON	COMETIC GASKET	L.A. SLEEVE GASKET	CYLINDER AFTERMARKET KITS	VALVE / SPRING KIT	VALVE GUIDE	CAMSHAFT	CAM CHAIN	CRANKSHAFT	CON-ROD KIT	CRANK BEARING	ENGINE OIL SEAL KIT				
Outlaw 450 MXR 2008-11 KTM Engine 448cc Single Liquid Cooled 89mm 3.504" <i>RESLEEVEING REQUIRED FOR OVERSIZES</i>	AC	FL-5442	89.00 89.01	Std. Std.	11:1 Comp. 6413A 6413B		11:1 Comp. 4941M08900	11:1 Comp. 8581DA	11:1 Comp. VT23329A VT23329B	12:1 Comp. 274221				C3263-EST						Pro-X 04925	NJ206 Bearing / Seal Kit CBS64003				
			89.00	Std.			13:1 Comp. 4942M08900		12:1 Comp. VT23340A	13:1 Comp. 274219															
			89.00	Std.			13.5:1 Comp. 4959M08900		13:1 Comp. VT23552A																
500 H.O. 1997-13 Sportsman, Scrambler Magnum Ranger 4x4 2006-13 499cc Liquid Cooled 92mm 3.622" <i>RESLEEVEING REQUIRED FOR OVERSIZES</i>	CI	FL-5368	92.00 92.50 93.00	Std. .020 .040	(03-13) 01.5513.000 01.5513.050 01.5513.100		10.2:1 Comp. 4677M09200 4677M09250 4677M09300	10.2:1 Comp. 8691DA 8691D050 8691D100	10.2:1 Comp. VT24356 VT24356050 VT24356100					Top End C7312 (thru 05)	Top End thru 2010 Sportsman Scrambler 35-0830 (06-12) H.O. EFI X2 35-0903				Hot Cams Camshaft 5426-1 (Stage 1)	Hot Rods HR4438	Hot Rods HR8715	49-822143 Bearing / Seal Kit HR00009			
ACE 500 2017-19 Ranger 500 2017-22 500cc Single Liquid Cooled 93mm 3.661"	AC	FL-5826	93.00	Std.					10:1 Comp. VT24482B																
Predator 500 2003-07 Outlaw 500 2006-07 ATP 500 2005 499cc Liquid Cooled 99.2mm 3.905"	AC	FL-5564	99.20 99.20	Std. Std.			12.5:1 Comp. 4807M09920	12.5:1 Comp. 8692DA		11:1 Comp. 209286 12.5:1 Comp. 221843				Top End C7995-EST (100mm)	Top End 35-0876 Complete w/oil seals 37-1907				Intake 82-82052 Exhaust 82-82055 Valve Springs 82-82012	Valve Guide IN / EX 82-82030 O/S +.001 82-82031	Hot Cams Camshaft 5045-11N (Intake) 5046-1E (Exhaust)	CC-5146			49-822249
Big Bore to 560cc 105mm 4.125"	BB	FL-5564B	105.00	.230			4914M10483			222388				C7996-EST (105mm)											
Outlaw 525 2007-09 KTM Engine 510cc Single Liquid Cooled 95mm 3.740" <i>RESLEEVEING REQUIRED FOR OVERSIZES</i>	AC	FL-5437	95.00 97.00 95.00 97.00	Std. .080 Std. .080	11:1 Comp. 6520A		11:1 Comp. 4731M09500 4731M09700 12.5:1 Comp. 4732M09500 4732M09700	11:1 Comp. 8547DA 8547D200		12.5:1 Comp. 274173 13:1 Comp. 274174				Top End C7944-EST (95mm) C7691-EST (97mm)	Top End 35-6528				Intake 28-65202 Exhaust 28-65201 Valve Springs 96-96000	Valve Guide Intake 96-96010 O/S +.001 96-96011 Exhaust 96-96020 O/S +.001 96-96021	Hot Cams Camshaft 3015-1	Pro-X 04925 Hot Rods HR8666	NJ206 Bearing / Seal Kit CBS64003		
Outlaw 525 2007-09 Big Bore to 565cc 100mm 3.937"	BB	FL-5437B	100.00	.200																					
XP 550 2009-14 Sportsman 549cc Single Liquid Cooled 96.6mm 3.803"	CI	FL-5381																							
RZR 570 2012-22 Ranger 570 2012-24 Sportsman 570 2014-24 ACE 570 2015-19 567cc Single Liquid Cooled 99mm 3.937" <i>RESLEEVEING REQUIRED FOR OVERSIZES</i> <i>CYLINDER WORKS COMPLETE KIT INCLUDES CYLINDER, PISTONS, GASKETS</i>	AC	FL-5768	99.00 99.50 100.00	Std. .020 .100	10.2:1 Comp. 01.5512.000 01.5512.050 01.5512.100		10.2:1 Comp. 40105M09900	10.2:1 Comp. 8951DA 8951D050 8951D100	10:1 Comp. VT24396B					Top End C3258-EST	Top End 35-24396	Cylinder Works 60005 (99mm Std.) Complete Kit 60005-K02 (99mm Std.)						Hot Rods HR8719	49-822170		

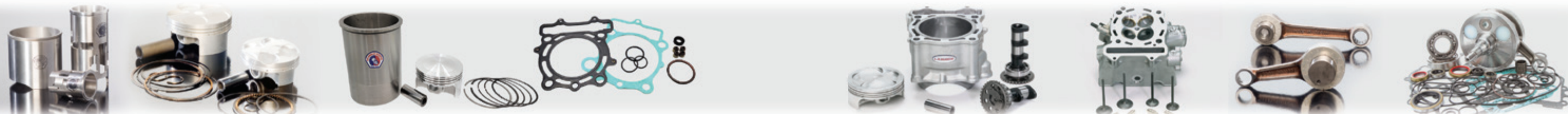

ATV-UTV ARCTIC CAT
ATV-UTV BOMBARDIER
ATV-UTV HONDA
ATV-UTV KAWASAKI
ATV-UTV KTM/KYMCO
ATV-UTV POLARIS
ATV-UTV SUZUKI
ATV-UTV YAMAHA
PERSONAL WATERCRAFT



MODEL
Engine Description
Cylinder I.D. (mm/in.)



SLEEVE

REBUILD KIT
Sleeve - Piston
Gasket - T.E. Bearing

BORE SIZE (mm)

PISTON SIZE

TOP END

TOP END

VALVE TRAIN

BOTTOM END

PRO-X PISTON

LAPC PISTON

WISECO PISTON

WOSSNER PISTON

VERTEX PISTON

JE PISTON

COMETIC GASKET

L.A. SLEEVE GASKET

CYLINDER AFTERMARKET KITS

VALVE / SPRING KIT

VALVE GUIDE

CAMSHAFT

CAM CHAIN

CRANKSHAFT

CON-ROD KIT

CRANK BEARING

ENGINE OIL SEAL KIT

POLARIS ATV-UTV FOUR-STROKE (CONTINUED)

MODEL	Year	AC	FL	BORE	STROKE	PRO-X PISTON	LAPC PISTON	WISECO PISTON	WOSSNER PISTON	VERTEX PISTON	JE PISTON	COMETIC GASKET	L.A. SLEEVE GASKET	CYLINDER AFTERMARKET KITS	VALVE / SPRING KIT	VALVE GUIDE	CAMSHAFT	CAM CHAIN	CRANKSHAFT	CON-ROD KIT	CRANK BEARING	ENGINE OIL SEAL KIT	
Sportsman 600 597cc Twin Liquid Cooled 76.5mm 3.012"	2003-05	AC	FL-5510																				
Sportsman 700 Ranger 700 683cc Twin Liquid Cooled 80mm 3.150"	2002-08 2007-09	AC	FL-5511	80.00	Std.					9.4:1 Comp. VT24430B (05-09)			Top End 35-0945 (04-09)	Cylinder Works 60002 (80mm Std.)					HR4422			Main Bearing / Seal Kit 49K084	
Sportsman 800 760cc Twin Liquid Cooled 80mm 3.150" <i>RESLEEVEING REQUIRED FOR OVERSIZES</i> <i>CYLINDER WORKS COMPLETE KIT INCLUDES CYLINDER, PISTONS, GASKETS</i>	2005-14	AC	FL-5594	80.00 80.01 82.00	Std. Std. .080	10:1 Comp. 5806A 5806B		10.2:1 Comp. 4961M08000 4961M08200		10.2:1 Comp. VT23643B VT23645A	10.75:1 Comp. 281815 * *(Set of 2) 281814 *		Top End C3250 (05-10) C3507 (82mm) (05-10)	Top End Sportsman 35-0945 (05-10) 35-0962 (11-14)	Cylinder Works 60002 (80mm Std.) Complete Kit 60002-K04 (80mm Std.) (11-14) 60002-K06 (80mm Std.)	Sportsman Intake 82-82065 Exhaust 82-82068 Valve Springs 82-82060	Sportsman Valve Guide Intake 82-82070 Exhaust 82-82080 Seals 71017-4	HC00051 (thru '09)	HR4091			49-822353 Main Bearing / Seal Kit 49K084	
Ranger 800 RZR 800 760cc Twin Liquid Cooled 80mm 3.150" <i>RESLEEVEING REQUIRED FOR OVERSIZES</i> <i>CYLINDER WORKS COMPLETE KIT INCLUDES CYLINDER, PISTONS, GASKETS</i>	2005-16 2008-14	AC	FL-5594	80.00 80.01 82.00	Std. Std. .080	10:1 Comp. 5805A 5805B (RZR)	10:1 Comp. 5806A 5806B (Ranger)	10.2:1 Comp. 4961M08000 4961M08200		10.2:1 Comp. VT23643B VT23645A	10.75:1 Comp. 281815 * *(Set of 2) 281814 *		Top End C3250 (08-10) C3507 (82mm) (08-10) C3506 (11-14) C3508 (82mm) (11-14)	Top End RZR 35-0945 (08-10) 35-0967 (11-14) Ranger 35-0945 (05-10) 35-0967 (11-16)	Cylinder Works 60002 (80mm Std.) Complete Kit Ranger (10) 60002-K04 (11-17) 60002-K05 RZR (08-10) 60002-K04	RZR Ranger (11-17) Intake 82-82312 Exhaust 82-82316 Valve Springs 82-82300	RZR Ranger (11-17) IN / EX 82-82320 Seals 71017-4	HC00051	HR4091 (08-16)			49-822353 Main Bearing / Seal Kit 49K084	
XP 850 Sportsman Scrambler XP 850 H.O. 850cc Twin Liquid Cooled 87mm 3.425" <i>RESLEEVEING REQUIRED FOR OVERSIZES</i>	2009-24 2013-24	CI AC	FL-5395	87.00 87.50 90.00	Std. .020 .120			11.1:1 Comp. 40106M08700	9.3:1 Comp. K8954DA-2 * K8954D050-2 * * Set of 2	11.1:1 Comp. VT24266B	11.5:1 Comp. 308408 (Set of 2) 308409 (Set of 2) Big Bore 909cc		Top End 35-0963 (09-13) 35-0992 (14-21) Complete w/oil seals 37-1992 (14-21)					HC0116	Hot Rods HR4430 (Thru 2021)	Hot Rods HR8720 Rod Bolts HR00090 (Thru 2021)		49-822188 Main Bearing / Seal Kit 49K241 (09-13) 49K242 (14-21)	



ATV-UTV ARCTIC CAT
ATV-UTV BOMBARDIER
ATV-UTV HONDA
ATV-UTV KAWASAKI
ATV-UTV KTM/KYMCO
ATV-UTV POLARIS
ATV-UTV SUZUKI
ATV-UTV YAMAHA
PERSONAL WATERCRAFT



MODEL
Engine Description
Cylinder I.D. (mm/in.)

SLEEVE

REBUILD KIT
Sleeve, Piston
Gasket, T.E. Bearing

BORE SIZE (mm)

PISTON SIZE

TOP END

TOP END

VALVE TRAIN

BOTTOM END

PRO-X PISTON

LAPC PISTON

WISECO PISTON

WOSSNER PISTON

VERTEX PISTON

JE PISTON

COMETIC GASKET

L.A. SLEEVE GASKET

CYLINDER AFTERMARKET KITS

VALVE / SPRING KIT

VALVE GUIDE

CAMSHAFT

CAM CHAIN

CRANKSHAFT

CON-ROD KIT

CRANK BEARING

ENGINE OIL SEAL KIT

POLARIS ATV-UTV FOUR-STROKE (CONTINUED)

MODEL	Year	AC	FL	SLEEVE	BORE SIZE (mm)	PISTON SIZE	PRO-X PISTON	LAPC PISTON	WISECO PISTON	WOSSNER PISTON	VERTEX PISTON	JE PISTON	COMETIC GASKET	L.A. SLEEVE GASKET	CYLINDER AFTERMARKET KITS	VALVE / SPRING KIT	VALVE GUIDE	CAMSHAFT	CAM CHAIN	CRANKSHAFT	CON-ROD KIT	CRANK BEARING	ENGINE OIL SEAL KIT	
RZR 900 XP EFI Ranger XP 900 ACE 900 875cc Liquid Cooled Mono-Block Twin 93mm 3.661" RESLEEVEING REQUIRED FOR OVERSIZES CYLINDER WORKS COMPLETE KIT INCLUDES CYLINDER, PISTONS, GASKETS	2011-24	AC	FL-5769				(14-21) Stock Comp. 5913A		(11-14) 10.6:1 Comp. 40045M09300 40092M09500	(14-21) RZR XP (15-19) Ranger XP	(14-19) 10.5:1 Comp. VT24398B	(11-14) 9:1 Comp. 363979 * 306364 * 306370 *	Top End C3446-EST (93.5mm) (11-14) C3447-EST (96mm) (11-14)	Top End Ranger, ACE (13-19) 35-0969 RZR 35-0969 (15-22) 35-0970 (11-14)	Cylinder Works (11-16) 60004 (93mm Std.) (17-23) 60007 (93mm Std.) Complete Kit (11-16) 60004-K02 (93mm Std.) (17-23) 60007-K02 (93mm Std.)	Ranger XP900 (13-19) RZR 900 (15-22) Intake 82-82255 Exhaust 82-82258 Valve Springs 82-82400	Valve Guide Intake 82-82270 O/S +.001 82-82271 Exhaust 82-82420 O/S +.001 82-82421	Hot Cams Camshaft (13-22) HC00043 (Intake) HC00044 (Exhaust)	CC-5511 (11-14) CC-5144 (17-22)	Hot Rods HR00016 Ranger 13-19 ACE 16-19 RZR 15-21 HR4423 RZR 13-14 HR4421 RZR 11-12	Hot Rods HR8716 Ranger 13-19 ACE 16-19 RZR 15-21 HR8704 RZR 11-14 Rod Bolts HR00089	Main Bearing / Seal Kit 49K101 (18-22) 49K087 (13-17)	49-822198 (11-15) 49-822200 (17-21)	
	93.00	Std.							12.5:1 Comp. 40046M09300 40093M09500	12:1 Comp. K8930DA-2 * K8930D200-2 * K8930D300-2 *	11.5:1 Comp. VT24028A	11:1 Comp. 363681 * 363366 * 306372 *												
	93.00	Std.											12:1 Comp. 363383 * 306368 * 306374 *											
900 RZR Big Bore 96mm 932cc to 98mm 971cc Special Siamese Flanged Sleeves Sold as a Set of 2 Sleeves Custom Machining required.	2011-21		FL-5769BX2							12:1 Comp. K8930D300-2 (Set of 2)		11:1 Comp. 306372 (Set of 2)	C3447-EST (96mm)											
										12:1 Comp. K8930D500-2 (Set of 2)		12:1 Comp. 306380 (Set of 2)												
General 1000 999cc Liquid Cooled Mono-Block Twin 93mm 3.661" RESLEEVEING REQUIRED FOR OVERSIZES CYLINDER WORKS COMPLETE KIT INCLUDES CYLINDER, PISTONS, GASKETS	2016-24	AC	FL-5777						11:1 Comp. 40128M09300	12:1 Comp. K8930DA-2 * K8930D200-2 *	10.5:1 Comp. VT24398B	9.5:1 Comp. 363684 *	C3546-EST (94mm) C3563-EST (96mm)	Top End 35-0969 Complete w/oil seals 37-1969	Cylinder Works 60003 (16) (93mm Std.) 60006 (17-23) (93mm Std.) Complete Kit (17-23) 60006-K02	Intake 82-82612 Exhaust 82-82616 Complete Head Service Kit 82-83150 Includes Std. Valves, Guides Spring Kit, Seals, Gaskets	Valve Guide Intake 82-82620 Exhaust 82-82630		HC5144	Hot Rods HR4424 Rod Bolts HR00080	Hot Rods HR8708 Rod Bolts HR00080	Main Bearing / Seal Kit 49K024	49-822200	
	93.00	Std.										10.5:1 Comp. 363685 * 11.5:1 Comp. 363387 * * Set of 2												
	93.00	Std.																						
Ranger 1000 XP EPS RZR 1000 XP EPS 999cc Liquid Cooled Mono-Block Twin 93mm 3.661" RESLEEVEING REQUIRED FOR OVERSIZES CYLINDER WORKS COMPLETE KIT INCLUDES CYLINDER, PISTONS, GASKETS.	2017-24	AC	FL-5777				10.5:1 Comp. 5913A		11:1 Comp. 40128M09300	12:1 Comp. K8930DA-2 * K8930D200-2 *	10.5:1 Comp. VT24398B	9.5:1 Comp. 363684 *	Top End C3546-EST (94mm) C3563-EST (96mm)	Top End Ranger XP RZR XP 35-0969 Complete w/oil seals 37-1969	Cylinder Works Ranger XP 60006 Complete Kit 60006-K02 RZR XP EPS 60003 (14-18) (93mm Std.) 60006 (19-20) (93mm Std.) Complete Kit 60003-K02 (93mm Std.) use w/ Polaris Tensioner #3022152 60006-K02 (93mm Std.)	RZR Intake 82-82612 Exhaust 82-82616 Turbo (16-22) Valve Set of 8 82-83100	RZR Valve Guide Intake 82-82620 Exhaust 82-82630	Hot Cams Ranger XP HC00043 (Intake) HC00044 (Exhaust) RZR XP Stage 1 5274-11N (Intake) 5275-1E (Exhaust) Stage 2 5276-21N (Intake) 5277-2E (Exhaust)	HC5144 Hot Cams Cam Chain Tensioner Conversion Kit HC00063	Hot Rods Ranger XP RZR (16-21) HR4424 Hot Rods Bottom End Kit RZR 1000 XP HR00111 (14-16) HR00110 (17) HR00106 (18-20) Includes Crankshaft, Bearings Seals, Complete Gasket Set	Hot Rods Ranger XP RZR XP HR8708 (2 Req.) Rod Bolts HR00080	Main Bearing / Seal Kit 49K088 (14-16) 49K087 (17) 49K024 (18-22 RZR) 49K101 (17-22 Ranger)	49-822200	
	93.00	Std.									RZR (14-23) 11.5:1 Comp. VT24028A	10.5:1 Comp. 363685 * 11.5:1 Comp. 363387 * * Set of 2												
	93.00	Std.																						
RZR 1000 Big Bore Big Bore to 1035cc 96mm Big Bore to 1110cc**98mm Special Closed Deck Ductile Iron Siamese Flanged Sleeves Sold in Set of 2 Sleeves			FL-5777CDSF							12:1 Comp. K8930D300-2 K8930D500-2 * Set of 2	11.5:1 Comp. VT24029A		Top End C3563-EST (96mm)											
										13:1 Comp. K8929D500-2 * Set of 2												Hot Rods HR8708 (2 Req.) Rod Bolts HR00080		



ATV-UTV
ARCTIC CAT

ATV-UTV
BOMBARDIER

ATV-UTV
HONDA

ATV-UTV
KAWASAKI

ATV-UTV
KTM/KYMCO

ATV-UTV
POLARIS

ATV-UTV
SUZUKI

ATV-UTV
YAMAHA

PERSONAL
WATERCRAFT



MODEL
Engine Description
Cylinder I.D. (mm/in.)



SLEEVE

REBUILD KIT
Sleeve - Piston
Gasket - T.E. Bearing

BORE SIZE (mm)

PISTON SIZE

TOP END

TOP END

VALVE TRAIN

BOTTOM END

PRO-X PISTON

LAPC PISTON

WISECO PISTON

WOSSNER PISTON

VERTEX PISTON

JE PISTON

COMETIC GASKET

L.A. SLEEVE GASKET

CYLINDER AFTERMARKET KITS

VALVE / SPRING KIT

VALVE GUIDE

CAMSHAFT

CAM CHAIN

CRANKSHAFT

CON-ROD KIT

CRANK BEARING

ENGINE OIL SEAL KIT

POLARIS ATV-UTV FOUR-STROKE (CONTINUED)

MODEL	AC	LA-5823**	90.50	Std.			12:1 Comp. K8940DA-2 * * Set of 2	11:1 Comp. VT24564B			Top End 35-0964 Complete w/oil seals 37-1964						HC0116	Hot Rods HR00026 (14-21) Rod Bolts HR00090	Hot Rods HR8720 (2 Req.) Rod Bolts HR00090	Main Bearing / Seal Kit 49K242	49-822188	
Scrambler 1000 XP 2014-24 Sportsman 1000 XP 2014-24 952cc Twin Liquid Cooled 90.50mm 3.562" <i>** INDIVIDUAL SLEEVE WITH NO FLANGE FOR SLEEVEING ONE CYLINDER.</i> <i>* SIAMESE FLANGED SLEEVES SOLD IN SET OF 2 SLEEVES</i>	AC	LA-5823**	90.50	Std.			12:1 Comp. K8940DA-2 * * Set of 2	11:1 Comp. VT24564B			Top End 35-0964 Complete w/oil seals 37-1964							HC0116	Hot Rods HR00026 (14-21) Rod Bolts HR00090	Hot Rods HR8720 (2 Req.) Rod Bolts HR00090	Main Bearing / Seal Kit 49K242	49-822188
Ranger XD 1500 2024 1498cc Triple Liquid Cooled 93mm 3.661" <i>* SIAMESE FLANGED SLEEVES SOLD IN SET OF 3 SLEEVES (2 END SLEEVES, 1 CENTER SLEEVE)</i>	ACI	FL-5856																				
RZR Pro R Sport 2.0L 2022-24 1997cc 4-Cyl. Liquid Cooled 93mm 3.661" <i>* SIAMESE FLANGED SLEEVES SOLD IN SET OF 4 SLEEVES (2 END SLEEVES, 2 CENTER SLEEVES)</i> <i>SINGLE FLAT FLANGED END SLEEVE</i> <i>DOUBLE FLAT FLANGED CENTER SLEEVE</i>	ACI	FL-5856																				

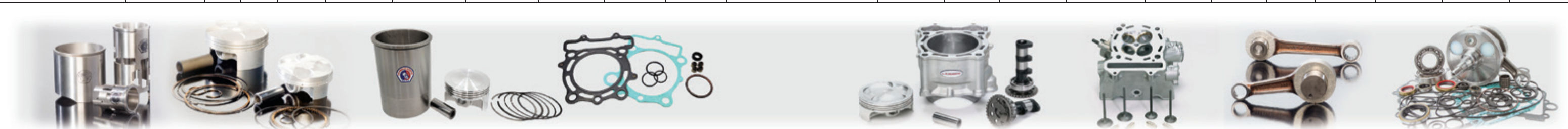

ATV-UTV ARCTIC CAT
ATV-UTV BOMBARDIER
ATV-UTV HONDA
ATV-UTV KAWASAKI
ATV-UTV KTM/KYMCO
ATV-UTV POLARIS
ATV-UTV SUZUKI
ATV-UTV YAMAHA
PERSONAL WATERCRAFT



MODEL
Engine Description
Cylinder I.D. (mm/in.)

SLEEVE

REBUILD KIT
Sleeve - Piston
Gasket - T.E. Bearing

BORE SIZE (mm)

PISTON SIZE

TOP END

TOP END

BOTTOM END

PRO-X PISTON

LAPC PISTON

WISECO PISTON

WOSSNER PISTON

VERTEX PISTON

T.E. BEARING

COMETIC GASKET

L.A. SLEEVE GASKET

CRANKSHAFT

CON-ROD KIT

CON-ROD ASSEMBLY
Rod - Bearings - Seals

CRANK BEARING

CRANK SEAL KIT

SUZUKI ATV-UTV TWO-STROKE

MODEL	Year	CC	FL	Stroke	Bore (mm)	Stroke (mm)	Stroke (in.)	PRO-X PISTON	LAPC PISTON	WISECO PISTON	WOSSNER PISTON	VERTEX PISTON	T.E. BEARING	COMETIC GASKET	L.A. SLEEVE GASKET	CRANKSHAFT	CON-ROD KIT	CON-ROD ASSEMBLY	CRANK BEARING	CRANK SEAL KIT		
LT-50 49cc 41mm	2002-05	CC	FL-5492		41.00 41.50 42.00 42.50 43.00	Std. .020 .040 .060 .080	01.3001 01.3001.50 01.3001.100			826M04100 826M04150 826M04200 826M04250 826M04300			T.E. Bearing B1000		Top End 35-0850							
QuadSport LT-80 82cc 50mm	All Years	RS	FL-5369		50.00 50.25 50.50 51.00 51.50 52.00	Std. .010 .020 .040 .060 .080	5210 5212 5214 5216			673M05000 673M05025 673M05050 673M05100 673M05150 673M05200	8282DA 8282D050 8282D100 8282D150 8282D200		T.E. Bearing 01215	Top End C7259	Top End 35-0849 Complete w/oil seals 37-1849		Pro-X 04932	39-4932	6204C3	094397 Bearing / Seal Kit 494397		
LT-250RF 247cc 70mm	1985 Liquid Cooled 2.756"	CI	FL-942		70.00 70.50 71.00 71.50 72.00	Std. .020 .040 .060 .080				534M07000 534M07050 534M07100 534M07150 534M07200	8257DA 8257D050 8257D100 8257D150 8257D200		T.E. Bearing 01401	Top End C7070	Complete w/oil seals 37-1834				Left 6232C3 Right 6206C3	094130 Bearing / Seal Kit 494130		
LT-250RG 247cc 70mm	1986 Liquid Cooled 2.756"	CI	FL-988		70.00 70.50 71.00 71.50 72.00	Std. .020 .040 .060 .080				534M07000 534M07050 534M07100 534M07150 534M07200	8257DA 8257D050 8257D100 8257D150 8257D200		T.E. Bearing 01401	Top End C7070	Complete w/oil seals 37-1834				Left 6232C3 Right 6206C3	094130 Bearing / Seal Kit 494130		
LT-250RH 246cc 67mm	1987 Liquid Cooled 2.637"	CS	FL-5020		67.00 67.50 68.00 68.50 69.00	Std. .020 .040 .060 .080				552M06700 552M06750 552M06800 552M06850 552M06900	8258DA 8258D050 8258D100 8258D150 8258D200		T.E. Bearing 01401	Top End C7071	Complete w/oil seals 37-1822		Hot Rods HR8164		Left 6232C3 Right 6206C3	094131 Bearing / Seal Kit 494131		
LT-250RJ, K, L, M, N QuadRacer 246cc 67mm	1988-92 Liquid Cooled 2.637"	CS	FL-5064	5064K	67.00 67.50 68.00 68.50 69.00	Std. .020 .040 .060 .080				571M06700 571M06750 571M06800 571M06850 571M06900	8259DA 8259D050 8259D100 8259D150 8259D200		T.E. Bearing 01401	Top End C7071	Complete w/oil seals 37-1822	HR4027 Hot Rods HR8164			Left 6232C3 Right 6206C3	094397 Bearing / Seal Kit 494131 Hot Rods Bottom End Kit CBK0065 Includes Crankshaft, Bearings Seals, Complete Gasket Set		
LT-500RH QuadRacer 499cc 86mm	1987 Single 6 Stud 3.386"	CI	FL-5021	5021K	86.00 86.50 87.00 87.50 88.00	Std. .020 .040 .060 .080				561M08600 561M08650 561M08700 561M08750 561M08800	8260DA 8260D050 8260D100 8260D150 8260D200		T.E. Bearing 01401	Top End C7072 (88mm) C7273 (89.5mm)	Complete w/oil seals 37-1835		Hot Rods HR8155		6306C3	094131 Bearing / Seal Kit 494132		
LT-500RJ, K, L QuadRacer 499cc 86mm	1988-90 Single 7 Stud 3.386"	CS	FL-5021H	5021K-1	88.50 89.00 89.50	.100 .120 .140				561M08850* 561M08900* 561M08950*	8260D250 8260D300 8260D350		T.E. Bearing 01401	Top End C7125 (91mm)						6306C3	094131 Bearing / Seal Kit 494132	
LT-500RJ, K, L QuadRacer 499cc 86mm	1988-90 Single 7 Stud 3.386"	CI	FL-5073	5073K	86.00 86.50 87.00 87.50 88.00	Std. .020 .040 .060 .080				561M08600 561M08650 561M08700 561M08750 561M08800	8260DA 8260D050 8260D100 8260D150 8260D200		T.E. Bearing 01401	Top End C7073 (88mm) C7274 (89.5mm) C7122 (91mm)	Complete w/oil seals 37-1823		Hot Rods HR8155				6306C3	094131 Bearing / Seal Kit 494132
LT-500RJ, K, L QuadRacer 499cc 86mm	1988-90 Single 7 Stud 3.386"	CS	FL-5073H	5073K-1	88.50 89.00 89.50	.100 .120 .140				561M08850* 561M08900* 561M08950*	8260D250 8260D300 8260D350		T.E. Bearing 01401	Top End C7122 (91mm)								

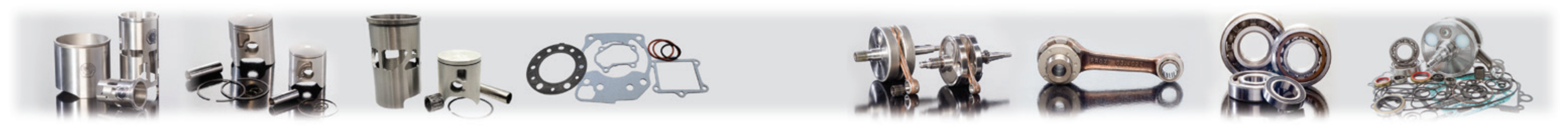

ATV-UTV
ARCTIC CAT
BOMBARDIER
HONDA
KAWASAKI
KTM/KYMCO
POLARIS
SUZUKI
YAMAHA
PERSONAL
WATERCRAFT



MODEL
Engine Description
Cylinder I.D. (mm/in.)

SLEEVE

REBUILD KIT
Sleeve - Piston
Gasket - T.E. Bearing

BORE SIZE
(mm)

PISTON SIZE

TOP END

TOP END

VALVE TRAIN

BOTTOM END

PRO-X PISTON

LAPC PISTON

WISECO PISTON

WOSSNER PISTON

VERTEX PISTON

JE PISTON

COMETIC GASKET

L.A. SLEEVE GASKET

CYLINDER AFTERMARKET KITS

VALVE / SPRING KIT

VALVE GUIDE

CAMSHAFT

CAM CHAIN

CRANKSHAFT

CON-ROD KIT

CRANK BEARING

ENGINE OIL SEAL KIT

SUZUKI ATV-UTV FOUR-STROKE

MODEL	Year Range	Engine Description	Cylinder I.D. (mm/in.)	PRO-X PISTON	LAPC PISTON	WISECO PISTON	WOSSNER PISTON	VERTEX PISTON	JE PISTON	COMETIC GASKET	L.A. SLEEVE GASKET	CYLINDER AFTERMARKET KITS	VALVE / SPRING KIT	VALVE GUIDE	CAMSHAFT	CAM CHAIN	CRANKSHAFT	CON-ROD KIT	CRANK BEARING	ENGINE OIL SEAL KIT							
QuadSport Z50	2006-09, 2017-24	49cc 36mm	1.417"																								
QuadSport Z90	2007-09, 2014-24	90cc 45.5mm	1.791"																								
LT, ALT-125	1982-87	124cc 57mm	Single 2.244"														CC-098		Left 6207C3 Right (83-84) 6328C3 Right (85-87) 6228C3								
LT-160, LT-F160	1989-04	158cc 58mm	Single 2.283"								Top End 35-0848		(IN / EX Set) 07-206				CC-098			49-822150							
LT, ALT-185	1984-87	178cc 63mm	Single 2.480"														CC-098		Left 6207C3 Right 6328C3								
LT-230	1985-94	229cc 66mm	Single 2.598"			66.00 66.50 67.00 67.50 68.00	Std. .020 .040 .060 .080					9.2:1 Comp. 2720 2722 2724	10.25:1 Comp. 4382M06600 4382M06650 4382M06700 4382M06750 4382M06800					Top End C7074 (thru 1993)	Complete w/oil seals 37-1809 (thru 1993)	(IN / EX Set) 07-204				Left 6207C3 Right 6328C3	49-822280		
LT-230 Big Bore to 260cc	1985-94	70mm	2.756"			70.00	Std.					W866PS								Left 6207C3 Right 6328C3 (85-88)	49-822280						
LT-250E, F, G	1985-94	249cc 72mm	Single 2.834"																								
LT-4WD Quadrunner 250 LTF-250, LT-F4WD, LT-F250F Ozark 250, Z250	1987-14	246cc 66mm	Single 2.598"			66.00 66.50 67.00 67.50 68.00	Std. .020 .040 .060 .080					9.2:1 Comp. 2720 2722 2724	10.25:1 Comp. 4382M06600 4382M06650 4382M06700 4382M06750 4382M06800	10.25:1 Comp. 8805DA 8805D050 8805D100 8805D150 8805D200					Top End C7260 (88-14)	Top End 35-0810 (87-01) 35-0886 (02-14)	(IN / EX Set) 07-205 (87-01) 07-204 (03-09)			CC-104	Left 6207C3 Right 6328C3	49-822151 (87-01) 49-822254 (02-14)	
LT-4WDX300 King Quad LT-F300F	1991-02	280cc 68.5mm	Single 2.697"			68.50 69.00 69.50	Std. .020 .040					8.5:1 Comp. 2730 2732 2734	8.9:1 Comp. 4673M06900 4673M06950							Top End C7314 (91-00)	Top End 35-0832 Complete w/oil seals 37-1832	(IN / EX Set) 07-205			CC-108	Left 6207C3 Right 6328C3	49-822152
LT-300E Quadrunner	1987-89	293cc 72mm	Single 2.835"										Top End C7459														
Eiger 400 King Quad 400	2002-24	376cc 82mm	Single 3.228"			82.00 82.50 83.00	Std. .020 .040						9:1 Comp. 2740 2742 2744								Top End 35-0846	(IN / EX Set) 07-2072			CC-108 (02-13)		49-822239



ATV-UTV ARCTIC CAT
ATV-UTV BOMBARDIER
ATV-UTV HONDA
ATV-UTV KAWASAKI
ATV-UTV KTM/KYMCO
ATV-UTV POLARIS
ATV-UTV SUZUKI
ATV-UTV YAMAHA
PERSONAL WATERCRAFT



MODEL
Engine Description
Cylinder I.D. (mm/in.)



SLEEVE

REBUILD KIT
Sleeve - Piston
Gasket - T.E. Bearing

BORE SIZE (mm)

PISTON SIZE

TOP END

TOP END

VALVE TRAIN

BOTTOM END

PRO-X PISTON

LAPC PISTON

WISECO PISTON

WOSSNER PISTON

VERTEX PISTON

JE PISTON

COMETIC GASKET

L.A. SLEEVE GASKET

CYLINDER AFTERMARKET KITS

VALVE / SPRING KIT

VALVE GUIDE

CAMSHAFT

CAM CHAIN

CRANKSHAFT

CON-ROD KIT

CRANK BEARING

ENGINE OIL SEAL KIT

SUZUKI ATV-UTV FOUR-STROKE (CONTINUED)

MODEL	Engine Description	Cylinder I.D. (mm/in.)	SLEEVE	REBUILD KIT	BORE SIZE (mm)	PISTON SIZE	PRO-X PISTON	LAPC PISTON	WISECO PISTON	WOSSNER PISTON	VERTEX PISTON	JE PISTON	COMETIC GASKET	L.A. SLEEVE GASKET	CYLINDER AFTERMARKET KITS	VALVE / SPRING KIT	VALVE GUIDE	CAMSHAFT	CAM CHAIN	CRANKSHAFT	CON-ROD KIT	CRANK BEARING	ENGINE OIL SEAL KIT			
Quadsport Z400 2002-14 398cc Liquid Cooled 90mm 3.543"	AC	FL-5430	5430K	90.00	Std.	12.25:1 Comp.	12.25:1 Comp.	12.25:1 Comp.	11.3:1 Comp.	12:1 Comp.			Top End C7978-EST (92mm)	Top End 35-3402	Cylinder Works 40001 (Std. 90mm)	Intake 28-34022 Exhaust 28-34021 Set 28-3402S	Valve Guide IN / EX 60-60060	Hot Cams Camshaft Stage 1 2249-11N (Intake)	CC-3403	HR4059	Pro-X 04921	6306RI	49-822201			
				90.01	Std. .040	5220A 5220B 5224	4713M09000	8563DA 8563DB	VT22951A VT22951B	180297						C7979-EST (94mm)	Complete w/oil seals 37-3402 (02-08)	Cylinder Works Complete Kit 40001-K01 (Std. 90mm)	O/S +.001 60-60061	2250-1E (Exhaust)			Hot Rods HR8630	Bearing / Seal Kit 49K049		
RESLEEVEING REQUIRED FOR OVERSIZES CYLINDER WORKS COMPLETE KIT INCLUDES CYLINDER, PISTON KIT AND TOP END GASKETS				90.00	Std.		4713M09200	13.5:1 Comp. 4714M09000	13.5:1 Comp. 8567DA	13.5:1 Comp. VT23550A						Intake O/S Valve +1mm 60-60051		2251-2IN (Intake)								
																Exhaust O/S Valve +1mm 60-60054		2252-2E (Exhaust)								
																Complete Head Service Kit 60-61790 Includes Std. Valves, Guides Spring Kit, Seals, Gaskets										
Quadsport Z400 2002-14 Big Bore 434cc to 450cc 94mm 3.700"	BB	FL-5430B		94.00	.160		12.5:1 Comp.	12.5:1 Comp.	11.5:1 Comp.	12:1 Comp.			Top End C7979-EST (94mm)		Cylinder Works 41001 (434cc 94mm)	Intake 28-34022 Exhaust 28-34021 Set 28-3402S	Valve Guide IN / EX 60-60060	Hot Cams Camshaft Stage 1 2249-11N (Intake)	CC-3403	HR4059	Pro-X 04921		Bearing / Seal Kit 49K049			
				94.50	.180		4795M09450	12:1 Comp. 8563D400																		
				95.00	.200			8563D550		12:1 Comp. 243651																
				95.50	.220																					
434cc 94.00mm 440cc 94.50mm 443cc 95.00mm 450cc 95.50mm				94.50	.180		13.5:1 Comp. 4796M09450						C3138-EST (96mm)		Cylinder Works Complete Kit 41001-K01 (434cc, 94mm)	Intake O/S Valve +1mm 60-60051		2250-1E (Exhaust)								
																Intake O/S Valve +1mm 60-60051			Stage 2 2251-2IN (Intake)							
																Exhaust O/S Valve +1mm 60-60054			2252-2E (Exhaust)							
																Valve Springs 60-60045										
																Valve Springs 60-60045										
																Valve Springs 60-60045										
King Quad 450 2007-10 454cc Single Liquid Cooled 84mm 3.307"	AC	FL-5678																								



ATV-UTV ARCTIC CAT
ATV-UTV BOMBARDIER
ATV-UTV HONDA
ATV-UTV KAWASAKI
ATV-UTV KTM/KYMCO
ATV-UTV POLARIS
ATV-UTV SUZUKI
ATV-UTV YAMAHA
PERSONAL WATERCRAFT



MODEL
Engine Description
Cylinder I.D. (mm/in.)

SLEEVE

REBUILD KIT
Sleeve, Piston
Gasket, T.E. Bearing

BORE SIZE
(mm)

PISTON SIZE

TOP END

TOP END

VALVE TRAIN

BOTTOM END

PRO-X PISTON

LAPC PISTON

WISECO PISTON

WOSSNER PISTON

VERTEX PISTON

JE PISTON

COMETIC GASKET

L.A. SLEEVE GASKET

CYLINDER AFTERMARKET KITS

VALVE / SPRING KIT

VALVE GUIDE

CAMSHAFT

CAM CHAIN

CRANKSHAFT

CON-ROD KIT

CRANK BEARING

ENGINE OIL SEAL KIT

SUZUKI ATV-UTV FOUR-STROKE (CONTINUED)

MODEL	AC	FL-5625	5625K	95.50 Std. 95.51 Std. 98.00 .100	11.7:1 Comp. 01.3406A 01.3406B	11.7:1 Comp. 4911M09550	11.7:1 Comp. 8667DA 8667DB 8667D250	11.7:1 Comp. VT23532A VT23532B VT23521A	12.8:1 Comp. 252743	Top End C3208-EST (96mm) C3157-EST (98mm) C3158-EST (101mm)	Top End 35-0916 Complete w/oil seals 37-1916 (06-08) 37-1935 (09)	Cylinder Works Plated Bore 40002 (Std. 95.5mm) Cylinder Works Complete Kit 40002-K01 (Std. 95.5mm)	Steel Intake 60-60310 Steel Exhaust 60-60313 Valve Springs 60-60280	Valve Guide Intake 60-60290 Exhaust 60-60300 Seals 71016-4	Hot Cams Camshaft 2072-11N Exhaust 2073-1E	CC-2706	HR4076	Hot Rods HR8648	Bearing / Seal Kit 49K051	49-822327	
Quad Racer LT-R450 2006-11 449cc Single Liquid Cooled 95.5mm 3.760"	AC	FL-5625	5625K	95.50 Std. 95.51 Std. 98.00 .100	11.7:1 Comp. 01.3406A 01.3406B	11.7:1 Comp. 4911M09550	11.7:1 Comp. 8667DA 8667DB 8667D250	11.7:1 Comp. VT23532A VT23532B VT23521A	12.8:1 Comp. 252743	Top End C3208-EST (96mm) C3157-EST (98mm) C3158-EST (101mm)	Top End 35-0916 Complete w/oil seals 37-1916 (06-08) 37-1935 (09)	Cylinder Works Plated Bore 40002 (Std. 95.5mm) Cylinder Works Complete Kit 40002-K01 (Std. 95.5mm)	Steel Intake 60-60310 Steel Exhaust 60-60313 Valve Springs 60-60280	Valve Guide Intake 60-60290 Exhaust 60-60300 Seals 71016-4	Hot Cams Camshaft 2072-11N Exhaust 2073-1E	CC-2706	HR4076	Hot Rods HR8648	Bearing / Seal Kit 49K051	49-822327	
<i>RESLEEVEING REQUIRED FOR OVERSIZES</i> <i>CYLINDER WORKS COMPLETE KIT INCLUDES CYLINDER, PISTON KIT AND TOP END GASKETS.</i>				95.50 Std.		13:1 Comp. 4912M09550	12.5:1 Comp. 8699DA	13:1 Comp. VT23553A	13.5:1 Comp. 252742				Cylinder Head Service Kit 60-67180 (06-09) <i>Includes Std. Valves, Guides Spring Kit, Seals, Gaskets</i>					Hot Rods Bottom End Kit CBK0177 <i>Includes Crankshaft, Bearings Seals, Complete Gasket Set</i>			
Quad Racer LT-R450 2006-11 Big Bore to 493cc 98mm to 100mm	BB/MO	FL-5625B		98.00 100.00	.100 .180	11.7:1 Comp. 4911M09800	11.7:1 Comp. 8667D250	11.7:1 Comp. VT23521A	12.8:1 Comp. 252747	Top End C3157-EST (98mm) C3158-EST (101mm)		Cylinder Works Complete Kit 41002-K01 (474cc 98mm)									
<i>COMPLETE CYLINDER KIT INCLUDES BIG BORE CYLINDER, PISTON KIT, AND TOP END GASKET KIT.</i>				87.50 87.51	Std. Std.		Vinson 10.2:1 Comp. 4068DA 4068DB				Top End 35-0828		(IN / EX Set) 07-2072 (98-07)								49-822259
LT-F500F 1998-06 LT-A500F 2000-17 Vinson 500 2002-08 King Quad 500 2008-24 493cc Single Liquid Cooled 87.5mm 3.444"	AC	FL-5370		87.50 87.51	Std. Std.		Vinson 10.2:1 Comp. 4068DA 4068DB				Top End 35-0828		(IN / EX Set) 07-2072 (98-07)								49-822259
Twin Peaks 700 2004-05 697cc V-Twin Liquid Cooled 82mm 3.228"	CI	KA-5526		82.00 82.50 83.00 83.50 84.00	Std. .020 .040 .060 .080	11.5:1 Comp. 4896M08200	11.3:1 Comp. 8697DA 8697D050 8697D100 8697D150 8697D200	9.9:1 Comp. VT24488 VT24488050		Top End C7982-EST (83mm) C3125-EST (84mm)	Top End 35-0880 Complete w/oil seals 37-1880		(IN / EX Set) 07-2072 (98-07)		Hot Cam Camshaft (Set IN / EX) 2031-S	CC-092 (2 Req.) CC-5046 (1 Req.)	Hot Rods HR4089	Hot Rods HR8675 (2 Req.) Rod Bolts HR00091	Main Bearing / Seal Kit 49K075	49-822251	
King Quad 700 2005-07 695cc Single Liquid Cooled 102mm 4.015"	AC	FL-5595		102.00	Std.		11.5:1 Comp. 8879DA											Wossner WR4045			
King Quad 700 2005-07 Big Bore to 750cc 106mm 4.170"	BB MO	FL-5595B		106.00	.160	11.5:1 Comp. CPM4014				Top End C3128-EST (106mm)											
King Quad 750 AXI 2009-24 722cc Single Liquid Cooled 104mm 4.094"	AC	FL-5374											Intake 60-61512 Exhaust 60-61516 Valve Springs 60-61550	Valve Guide IN / EX 60-61520 O/S+.001 60-61521							



ATV-UTV
ARCTIC CAT

ATV-UTV
BOMBARDIER

ATV-UTV
HONDA

ATV-UTV
KAWASAKI

ATV-UTV
KTM/KYMCO

ATV-UTV
POLARIS

ATV-UTV
SUZUKI

ATV-UTV
YAMAHA

PERSONAL
WATERCRAFT



MODEL
Engine Description
Cylinder I.D. (mm/in.)



SLEEVE

REBUILD KIT
Sleeve • Piston
Gasket • T.E. Bearing

BORE SIZE (mm)

PISTON SIZE

TOP END

TOP END

BOTTOM END

PRO-X PISTON

LAPC PISTON

WISECO PISTON

WOSSNER PISTON

VERTEX PISTON

T.E. BEARING

COMETIC GASKET

L.A. SLEEVE GASKET

CRANKSHAFT

CON-ROD KIT

CON-ROD ASSEMBLY
Rod • Bearings • Seals

CRANK BEARING

CRANK SEAL KIT

YAMAHA ATV-UTV TWO-STROKE

YFS-200 Blaster 1988-06 195cc Single 66mm 2.598" <i>SPECIAL HEAVY O.D. TO REPAIR BROKEN CYLINDER SKIRT.</i>	CI	YA-5035	5035K	66.00 66.25 66.50 66.75	Std. .010 .020 .030	4170 4171 4172 4173		573M06600 573M06625 573M06650 573M06675	8101DA 8101D050	VT22569 VT22569025 VT22569050 VT22569075		T.E. Bearing 01201	Top End C7093	Top End 35-2280	Hot Rods HR4005	Pro-X 04963	39-4963	Left (Ignition) 83A915 Right (Drive) 6305RI	Engine Oil Seal Kit 49-822153	
	CS	YA-5035H	5035K-1	67.00 67.25 67.50 67.75 68.00 68.25	.040 .050 .060 .070 .080 .100	4174 4176 4177 4178		573M06700 573M06725 573M06750 573M06775 573M06800 573M06825	8101D100 8101D150 8101D200	VT22569100 VT22569150 VT22569200				Complete w/oil seals 37-2280		Hot Rods HR8144			Bearing / Seal Kit 49K017	
YFS-200 Blaster 1988-06 Big Bore to 240cc 72mm 2.835" <i>(HEAD MODIFICATION REQUIRED)</i>	CS	YA-5035B		72.00 72.50 73.00	Std. .020 .040							T.E. Bearing 01201	Top End GS5035		HR4005	Pro-X 04963	39-4963		Bearing / Seal Kit 49K017	
								W240PS W240P2 W240P4								Hot Rods HR8144				
Tri-Z 250N 1985-89 (No. 38W) 246cc Liquid Cooled 68mm 2.677"	CS	YA-879	879K	68.00 68.50 69.00 69.50 70.00	Std. .020 .040 .060 .080			515M06800 515M06850 515M06900 515M06950 515M07000	8175DA 8175D050 8175D100 8175D150 8175D200			T.E. Bearing 01251	Top End C7153			Pro-X 04981	39-4981	6206C3	094284	
																			Bearing / Seal Kit 494284A	
YFZ-350 Banshee 1987-06 347cc Twin Liquid Cooled 64mm 2.520" <i>SPECIAL HEAVY O.D. TO REPAIR BROKEN CYLINDER SKIRT. ALSO FOR USE WITH 2.5MM AND 3MM OVERSIZE PISTONS.</i>	CI	YA-5023	5023K	64.00 64.25 64.50 64.75 65.00 65.25 65.50 65.75 66.00 66.25 66.50 67.00	Std. .010 .020 .030 .040 .050 .060 .070 .080 .090 .100 .120	4190 4191 4192 4193 4194 4195 4196 4197 4198		513M06400 513M06425 513M06450 513M06475 513M06500 513M06525 513M06550	8075DA 8075D050 8075D100 8075D150	VT22568 VT22568025 VT22568050 VT22568075 VT22568100		T.E. Bearing 01201	Top End C7094	Top End 35-2019	Hot Rods HR4001	Pro-X 04913	39-4958	Pinned Left, Center 83464A	Seal Kit 094958	
	CS	YA-5023H						513M06500 513M06525 513M06550 513M06600 513M06625 513M06650	8075D100 8075D150 8075D200 8075D250 8075D300	VT22568100 VT22568150 VT22568200				Complete w/oil seals 37-2019		Hot Rods HR8121	Long Rod Kit (+ 5mm) HR8158	Grooved Right 83406	Engine Oil Seal Kit 49-822154	
																			Bearing / Seal Kit 49K225	
YFZ-350 Banshee 1987-06 Big Bore to 409cc 68mm 2.677" <i>(HEAD MODIFICATION REQUIRED, ALTERNATE: PRO-DESIGN HEAD, PART NO. CH5023)</i>	CS	YA-5023B		68.00 68.25 68.50 69.00 69.50	Std. .010 .020 .040 .060							T.E. Bearing 01201	Top End C7316 (68mm) C7710 (69.50mm)			Pro-X 04913	39-4958	Pinned Left, Center 83464A	094958	
								W5023PS W5023P2 W5023P4 W5023P6 CAST PX409P2 PX409P4 PX409P6 <i>Limited To Available Stock</i>	8075D400 8075D425 8075D450							Hot Rods HR8121		Grooved Right 83406	Bearing / Seal Kit 49K225	



ATV-UTV
ARCTIC CAT

ATV-UTV
BOMBARDIER

ATV-UTV
HONDA

ATV-UTV
KAWASAKI

ATV-UTV
KTM/KYMCO

ATV-UTV
POLARIS

ATV-UTV
SUZUKI

ATV-UTV
YAMAHA

PERSONAL
WATERCRAFT



MODEL
Engine Description
Cylinder I.D. (mm/in.)



SLEEVE

REBUILD KIT
Sleeve - Piston
Gasket - T.E. Bearing

BORE SIZE (mm)

PISTON SIZE

TOP END

TOP END

VALVE TRAIN

BOTTOM END

PRO-X PISTON

LAPC PISTON

WISECO PISTON

WOSSNER PISTON

VERTEX PISTON

JE PISTON

COMETIC GASKET

L.A. SLEEVE GASKET

CYLINDER AFTERMARKET KITS

VALVE / SPRING KIT

VALVE GUIDE

CAMSHAFT

CAM CHAIN

CRANKSHAFT

CON-ROD KIT

CRANK BEARING

ENGINE OIL SEAL KIT

YAMAHA ATV-UTV FOUR-STROKE

MODEL	Year	CI	YA-#	SLEEVE	REBUILD KIT	BORE SIZE (mm)	PISTON SIZE	PRO-X PISTON	LAPC PISTON	WISECO PISTON	WOSSNER PISTON	VERTEX PISTON	JE PISTON	COMETIC GASKET	L.A. SLEEVE GASKET	CYLINDER AFTERMARKET KITS	VALVE / SPRING KIT	VALVE GUIDE	CAMSHAFT	CAM CHAIN	CRANKSHAFT	CON-ROD KIT	CRANK BEARING	ENGINE OIL SEAL KIT		
YFZ-50 49cc 39mm	2017-24	CI	YA-5563														Top End 35-0878									
Moto-4, YFM-80, 1985-08 Badger Raptor 80, Grizzly 79cc 47mm		CI	YA-941			47.00 47.50 48.00	Std. .020 .040			9.6:1 Comp. 2810 2812 2814							Top End 35-0851						(IN / EX Set) 07-309			
Raptor 90 Grizzly 90 88cc 47mm	2016-23 2019-24	CI	YA-5691																							
Raptor 110 112cc 52.4mm	2024 Single 2.063"		YA-5863																							
YFM-100 Champ 98cc 49mm	1987-91 Single 1.929"	CI	YA-5022																					6304C3		
YFA 125 Grizzly 125 Breeze 125 124cc 49mm	2005-13 1989-05 Single 1.929"	CI	YA-5230																					49-822259		
Raptor 125 124cc 54mm	2012-13 Single 2.124"	RS	YA-5426			54.00 54.50 55.00	Std. .020 .040																			
Tri-Moto 200, YTM-200L, YFM-200 196cc 67mm	1984-91 Single 2.638"	RS	YA-762			67.00 67.50 68.00	Std. .020 .040			9:1 Comp. 2820 2822 2824							Top End C7095 (85-89)							Pro-X 32320	49-822273	
BW-200N 196cc 67mm	1985-90 Single 2.638"	RS	YA-762																						Pro-X 32320	
Tri-Moto 225, YTM-225, YFM-225 223cc 70mm	1984-89 Single 2.756"	RS	YA-812			70.00 70.50 71.00	Std. .020 .040			9.5:1 Comp. 2830 2832 2834							Top End C7253 (YFM 86-88)								(IN / EX Set) 07-301	49-822273
YFB-250 Timberwolf YFM-250 Bear Tracker 1990-04 Big Bear 250 Bruin 250 229cc 71mm	1990-00 1999-04 2007-09 2005-06 Single 2.795"	RS	YA-5101			71.00 71.50 72.00 72.50 73.00	Std. .020 .040 .060 .080			Stock Comp. 2840 2842 2844							Top End C7254								(IN / EX Set) 07-301	

ATV-UTV
ARCTIC CAT

ATV-UTV
BOMBARDIER

ATV-UTV
HONDA

ATV-UTV
KAWASAKI

ATV-UTV
KTM/KYMCO

ATV-UTV
POLARIS

ATV-UTV
SUZUKI

ATV-UTV
YAMAHA

PERSONAL
WATERCRAFT





SLEEVE	REBUILD KIT <small>Sleeve - Piston Gasket - T.E. Bearing</small>	BORE SIZE (mm)	PISTON SIZE	TOP END							TOP END			VALVE TRAIN				BOTTOM END			
				PRO-X PISTON	LAPC PISTON	WISECO PISTON	WOSSNER PISTON	VERTEX PISTON	JE PISTON	COMETIC GASKET	L.A. SLEEVE GASKET	CYLINDER AFTERMARKET KITS	VALVE / SPRING KIT	VALVE GUIDE	CAMSHAFT	CAM CHAIN	CRANKSHAFT	CON-ROD KIT	CRANK BEARING	ENGINE OIL SEAL KIT	

YAMAHA ATV-UTV FOUR-STROKE (CONTINUED)

Raptor 250 2008-13 249cc Single 74mm 2.913" <i>RESLEEVEING REQUIRED FOR OVERSIZES</i>	AC	YA-5679	5679K	74.00	Std.			10.5:1 Comp.	12:1 Comp.		10.5:1 Comp.	Top End	Top End						Hot Rods		49-822339				
					76.00	.080									C3223-EST (74mm)	C35-0924					HR8676	Bearing / Seal Kit	49K059		
Raptor 250 Big Bore 270cc 77mm 277cc 78mm 283cc 80mm 300cc 81mm	BB MO	YA-5679B	77mm-78mm	77.00	.120			11:1 Comp.	12:1 Comp.			Top End													
					78.00	.160									C3224-EST (76mm)	Complete w/oil seals 37-1924									
				BB	YA-5726		80.00	.240																	
				MO			81.00	.280																	
YFM-350 Grizzly 350 2007-14 Raptor 350 2005-13 Bruin 350 2004-06 Wolverine 1995-09 Warrior 1987-05 Big Bear 1987-99 BW-350 1987-88 349cc Single 83mm 3.268"	RS	YA-5024	5024K	83.00	Std.	9.2:1 Comp.	9.2:1 Comp.	10.25:1 Comp.	10.5:1 Comp.	10.25:1 Comp.	10.5:1 Comp.	Top End	Top End	05041 (83mm Std.)	Intake	Valve Guide	Hot Cams	CC-2487	Hot Rods	Hot Rods	49-822279				
					83.25	.010	01.2487.000	65.6810A	4419M08300	8605DA	VT23103				C7096-EST (84mm)	C35-2160		28-24872 Exhaust	IN / EX 80-8010	4017-1 (Stage 1)	Raptor, Warrior	Raptor Warrior	Raptor Warrior	Bearing / Seal Kit	
					83.50	.020	01.2487.050	65.6810.025	4419M08350	8605D050	VT23103050								28-24871			CC-5110 Bruin, Grizzly	HR4043	HR8605	49K239
					83.75	.030	01.2487.100	65.6810.075	4419M08400	8605D100	VT23103100								Valve Springs 80-8000				Hot Rods Bottom Kit CBK0082 <i>Raptor / Warrior Includes Crankshaft, Bearings Seals, Complete Gasket Set</i>		Raptor / Warrior
Kodiak 400 1993-99 Big Bear 400 2000-12 387cc Single 83mm 3.268"	RS	YA-5231	5231K	83.00	Std.		8.6:1 Comp.	8.6:1 Comp.	8.6:1 Comp.			Top End	Top End		Intake	Valve Guide	Hot Cams				49-822218				
					83.25	.010		65.6815A	4676M08300	8903DA								28-24872 Exhaust	IN / EX 80-8010	4017-1 (Stage 1)			(99-06)		
					83.50	.020		65.6815.050	4676M08350	8903D050								28-24871						49-822279	
					83.75	.030		65.6815.075	4676M08400	8903D100								Valve Springs 80-8000						(thru 06)	(93-98)
Kodiak 400 2000-06 Grizzly 400 2007-08 401cc Liquid Cooled 84.5mm 3.327" (Cylinder No. 5GH)	RS	YA-5425	5425K	84.50	Std.		Stock Comp.	10.5:1 Comp.	10.5:1 Comp.				Top End								49-822247				
					85.00	.020		4720	40076M08450	8901DA															
					85.00	.040		4722	40076M08500	8901D050															
					85.50	.040		4724	40076M08500	8901D100															
Grizzly 450 2007-14 Kodiak 450 2003-06 Wolverine 450 2006-10 421cc Liquid Cooled 84.5mm 3.327" (Cylinder No. 5ND)	RS	YA-5513	5513K	84.50	Std.		10:1 Comp.	11:1 Comp.	11:1 Comp.	10:1 Comp.	10.5:1 Comp.	Top End	Top End					CC-0116	Hot Rods	HR8703	49-822247				
					85.00	.020		4710	4939M08450	8904DA	VT24483											HR4413		Bearing / Seal Kit	
					85.50	.040		4712	4939M08500	8904D050	VT24483050													49K081	
					86.50	.080		4714	4939M08550	8904D100													Hot Rods Bottom End Kit CBK0192 <i>Includes Crankshaft, Bearings Seals, Complete Gasket</i>		
Kodiak 450 2018-24 421cc Liquid Cooled 84.5mm 3.327" (Cylinder No. 5ND)	RS	YA5513	5513K-1	84.50	Std.		10:1 Comp.	11:1 Comp.	11:1 Comp.	10:1 Comp.	10.5:1 Comp.	Top End	Top End					CC-0116			49-822247				
					85.00	.020		4710	4939M08450	8904DA	VT24483														
					85.00	.040		4712	4939M08500	8904D050	VT24483050														
					86.50	.080		4714	4939M08550	8904D100															



ATV-UTV ARCTIC CAT
 BOMBARDIER
 HONDA
 KAWASAKI
 KTM/KYMCO
 POLARIS
 SUZUKI
 YAMAHA
 PERSONAL WATERCRAFT



MODEL
Engine Description
Cylinder I.D. (mm/in.)



SLEEVE

REBUILD KIT
Sleeve - Piston
Gasket - T.E. Bearing

BORE SIZE (mm)

PISTON SIZE

TOP END

TOP END

VALVE TRAIN

BOTTOM END

PRO-X PISTON

LAPC PISTON

WISECO PISTON

WOSSNER PISTON

VERTEX PISTON

JE PISTON

COMETIC GASKET

L.A. SLEEVE GASKET

CYLINDER AFTERMARKET KITS

VALVE / SPRING KIT

VALVE GUIDE

CAMSHAFT

CAM CHAIN

CRANKSHAFT

CON-ROD KIT

CRANK BEARING

ENGINE OIL SEAL KIT

YAMAHA ATV-UTV FOUR-STROKE (CONTINUED)

MODEL	Year	Code	Part No.	Bore	Stroke	Comp.	Comp.	Comp.	Comp.	Comp.	Comp.	Top End	Top End	Cylinder Works	Intake	Exhaust	Seals	Hot Cams	CC	Hot Rods	Bottom End	Bearing / Seal Kit	Part No.	
Rhino 450 421cc Liquid Cooled 84.5mm 3.327" (Cylinder No. 5ND)	2006-09	RS	YA-5513	5513K	84.50	Std.	10:1 Comp. 4710	11:1 Comp. 4939M08450	11:1 Comp. 8904DA	10:1 Comp. VT24483	10.5:1 Comp. 261962	Top End 35-0875							CC-0116	Hot Rods HR4413	HR8703	Bearing / Seal Kit 49K081	49-822247	
YFZ-450 (Cylinder No. 5TA) 439cc, 449cc Liquid Cooled 95mm 3.740" RESLEEVE REQUIRED FOR OVERSIZES COMPLETE CYLINDER KIT INCLUDES CYLINDER, PISTON KIT, AND TOP END GASKET KIT.	2004-13	AC	YA-5495	5495K	95.00	Std.	(04-05) 12:1 Comp. (06-13) 11.4:1 Comp.	(04-05) 12:1 (06-13) 11.4:1	(04-05) 12:1 (06-13) 11.4:1	(04-05) 12:1 (06-13) 11.4:1	(06-13) 12.5:1 Comp. 247957	Top End C3066-EST (96mm)	Top End 35-2434	Cylinder Works 20001 (Std. 95mm)	Intake 1X Titanium 28-24232 Steel	Valve Guides Intake 80-80220	Hot Cams Stage 2 (04-09) 4023-1IN (Intake) 4044-1E (Exhaust)	CC-2423	Hot Rods (04-05) HR4062	(04-05) Pro-X 04922	83C072C	49-822238		
YFZ-450 Big Bore to 478cc 98mm 3.858"	2004-13		YA-5495		95.00	Std.		4865M09500	4067DA	4067DB	247953	C3445-EST (97mm)	Complete w/oil seals 37-2434	Cylinder Works Complete Kit 20001-K01 (Std. 95mm)	80-80215H	Exhaust 80-80230	Seals 80-80710			Hot Rods (06-09) HR4073	Hot Rods HR8620			
YFZ-450R YFZ-450X (Cylinder No. 2S2) 449cc Liquid Cooled 95mm 3.740" RESLEEVE REQUIRED FOR OVERSIZES COMPLETE CYLINDER KIT INCLUDES CYLINDER, PISTON KIT, AND TOP END GASKET KIT.	2009-24 2011-11	AC	YA-5627	5267K-1	95.00	Std.	11.6:1 Comp. 4680A	11.4:1 Comp. 4865M09500	11.4:1 Comp. 4607DA	12:1 Comp. VT22984A	12.5:1 Comp. 247957	Top End C7908-EST (95mm)	Top End 35-0944	Cylinder Works 20003 (Std. 95mm)	Intake 1X Titanium 28-24232 Steel	Valve Guides Intake 80-80220	Hot Cams Camshaft Stage 1 4286-1IN (Intake) 4287-E (Exhaust)	CC-2429	Hot Rods (09-13) HR4405	Pro-X (09-13) 03.2439	SX06C84	49-822350		
YFZ-450R Big Bore to 480cc 98mm 3.858"	2009-23	BB	YA-5627		98.00	.120		4865M09600	4607DB	4607DC	247953	C3178-EST (98mm)	Complete w/oil seals 37-1944	Cylinder Works Complete Kit 20003-K02 (Std. 95mm)	80-80215H	Exhaust 80-80230				Hot Rods (14-22) HR00047	Hot Rods HR8688			
Grizzly 550 558cc Liquid Cooled 92mm 3.622"	2009-14	RS	YA-5690								247956	Top End C3279-EST (99mm)			Intake 2X Titanium 28-24233 Steel	Stage 2 4288-2IN (Intake) 4289-1E (Exhaust)	Cylinder Head Service Kit 80-82060 Includes Std. Valves, Guides Spring Kit, Seals, Gaskets		Hot Rods Bottom End Kit HR00124 (14-22) CBK0179 (09-13) Includes Crankshaft, Bearings Seals, Complete Gasket Set					
YFZ-450R Big Bore to 480cc 98mm 3.858"	2009-23	BB	YA-5627		98.00	.120				12:1 Comp. VT23403A	13:1 Comp. 247952	Top End C3178-EST		Cylinder Works Big Bore Complete Kit 21003-K02 (478cc, 98mm)						Hot Cams Camshaft Stage 2 4288-2IN (Intake) 4289-1E (Exhaust)				



ATV-UTV
ARCTIC CAT
BOMBARDIER
HONDA
KAWASAKI
KTM/KYMCO
POLARIS
SUZUKI
YAMAHA
PERSONAL
WATERCRAFT



SLEEVE				TOP END								TOP END				VALVE TRAIN				BOTTOM END			
REBUILD KIT Sleeve, Piston Gasket, T.E. Bearing	BORE SIZE (mm)	PISTON SIZE		PRO-X PISTON	LAPC PISTON	WISECO PISTON	WOSSNER PISTON	VERTEX PISTON	JE PISTON		COMETIC GASKET	L.A. SLEEVE GASKET	CYLINDER AFTERMARKET KITS	VALVE / SPRING KIT	VALVE GUIDE	CAMSHAFT	CAM CHAIN	CRANKSHAFT	CON-ROD KIT	CRANK BEARING	ENGINE OIL SEAL KIT		

YAMAHA ATV-UTV FOUR-STROKE (CONTINUED)

Grizzly 600 595cc 95mm	1998-01 Single 3.740"	RS	YA-814		95.00 95.50 95.75 96.00 96.25 96.50 96.75 97.00	Std. .020 .030 .040 .050 .060 .070 .080	8.5:1 Comp. 7050 7052 7053 7054 7055 7056 7057 7058		8.5:1 Comp. 4797M09500		8.5:1 Comp. 8501DA 8501D050			Top End C7213	Top End 35-0833			(IN / EX Set) 07-3112					
Grizzly 600 to 635cc 98mm	3.858"	BB MO	YA-814BB		98.00	.120			10:1 Comp. 4607M09800		9:1 Comp. 8501D300			Top End C7276									
YFM-660 Raptor Grizzly 660 660cc 100mm	2001-06 2002-08 Liquid Cooled 3.937"	RS	YA-7018	7018K (Raptor) 7018K-1 (Grizzly)	100.00 100.50 101.00 102.00	Std. .020 .040 .080	9.1:1 COMP. 4670 4672 4674	9.9:1 COMP. 65.6820A 65.6820.050 65.6820.100	11:1 Comp. 4737M10000 4737M10050 4737M10100 4811M10200	9.1:1 Comp. 8507DA 8507D050 8507D150 8507D200	9.1:1 Comp. VT23104 VT23104050 VT23104100	10.75:1 Comp. 272144 272146 272148 272145 272147 272149		Top End C7044-EST (100mm) C7798-EST (102mm)	Raptor Top End 35-2660 Complete w/oil seals 37-2660 Grizzly Top End 35-0865 Complete w/oil seals 37-1865		Intake 28-26612 Exhaust 28-26611 Valve Springs 80-80030	Valve Guide Intake 80-80040 O/S +.001 80-80041 Exhaust 80-80050 O/S +.001 80-80051	Hot Cams Camshaft Raptor 4011-1 (Stage 1) 4005-2 (Stage 2) Grizzly 4034-1 Mudbuster Grizzly 4100-1 (Stage 1)	Raptor CC-2661 Grizzly HR4080	Raptor HR4044 Grizzly HR4080	Pro-X 04939 (02-08) Hot Rods HR8614 (02-08)	6307C3 Bearing / Seal Kit 49K070 <i>Used when Rebuilding Crankshaft</i> Bearing / Seal Kit 49K024 <i>Used with New Crankshaft</i>
YFM-660 Raptor Grizzly 660 Big Bore to 727cc 105mm <i>CASE MODIFICATION REQUIRED</i>	2001-06 2002-08 4.134"	BB MO	YA-7018B		105.00	.196							12:1 Comp. 314758	Top End C7909-EST									
Rhino 660 660cc Single Liquid Cooled 100mm	2005-08 3.937"	RS	YA-7018		100.00 100.50 101.00 102.00	Std. .020 .040 .080	9.1:1 COMP. 4670 4672 4674	9.9:1 COMP. 65.6820A 65.6820.050 65.6820.100	9.9:1 Comp. 4966M10000 4966M10050 4966M10100 4966M10200	9.1:1 Comp. 8507DA 8507D050 8507D150 8507D200	9.1:1 Comp. VT23104 VT23140050 VT23104100	10.75:1 Comp. 272144 272146 272148		Top End C7044-EST (100mm) C7798-EST (102mm)	Top End 35-0865 Complete w/oil seals 37-1865	Intake 28-26612 Exhaust 28-26611 Valve Springs 80-80030	Valve Guide Intake 80-80040 O/S +.001 80-80041 Exhaust 80-80050 O/S +.001 80-80051	Hot Cams Camshaft 4034-1 Mudbuster 4100-1 (Stage 1)	CC-1331	Hot Rods HR4080	Pro-X 04939 Hot Rods HR8614	6307C3 Bearing / Seal Kit 49K240 <i>Used when Rebuilding Crankshaft</i> Bearing / Seal Kit 49K024 <i>Used with New Crankshaft</i>	
Rhino 660 Big Bore to 727cc 105mm <i>CASE MODIFICATION REQUIRED</i>	2005-08 4.134"	BB MO	YA-7018B		105.00	.196							12:1 Comp. 314758	Top End C7909-EST									

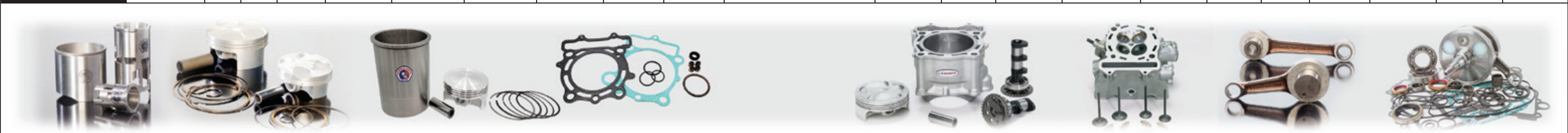

ATV-UTV ARCTIC CAT
ATV-UTV BOMBARDIER
ATV-UTV HONDA
ATV-UTV KAWASAKI
ATV-UTV KTM/KYMCO
ATV-UTV POLARIS
ATV-UTV SUZUKI
ATV-UTV YAMAHA
PERSONAL WATERCRAFT



MODEL
Engine Description
Cylinder I.D. (mm/in.)

SLEEVE

REBUILD KIT
Sleeve, Piston
Gasket, T.E. Bearing

BORE SIZE (mm)

PISTON SIZE

TOP END

TOP END

VALVE TRAIN

BOTTOM END

PRO-X PISTON

LAPC PISTON

WISECO PISTON

WOSSNER PISTON

VERTEX PISTON

JE PISTON

COMETIC GASKET

L.A. SLEEVE GASKET

CYLINDER AFTERMARKET KITS

VALVE / SPRING KIT

VALVE GUIDE

CAMSHAFT

CAM CHAIN

CRANKSHAFT

CON-ROD KIT

CRANK BEARING

ENGINE OIL SEAL KIT

YAMAHA ATV-UTV FOUR-STROKE (CONTINUED)

MODEL	Year	AC	YA-5609	5609K (06-14)		(06-14)	(06-14)	(06-14)	(06-14)	(06-14)		Top End C3142-EST (103mm)	Top End (06-14) 35-0923	Cylinder Works 20004 (Std. 102mm)	Intake 80-80430	Valve Guide IN / EX 80-80420	Hot Cams Camshaft (09-21) Stage 1 4131-1 Stage 2 4132-2 Stage 3 4133-3	CC-2706	Hot Rods HR4078	Pro-X 03.2706	6308YA3	49-822338		
Raptor 700R (Cylinder No. 1S3) 686cc Liquid Cooled 102mm 4.016" <i>RESLEEVEING REQUIRED FOR OVERSIZES</i> <i>CYLINDER WORKS COMPLETE CYLINDER KIT INCLUDES CYLINDER, PISTON KIT, AND TOP END GASKETS.</i>	2006-24	AC	YA-5609	5609K-1 (15-22)	102.00 102.01 103.00	Std. Std. .040	9.1:1 Comp. 01.2706A 01.2706B	9.2:1 Comp. 4902M10200 4902M10300	11:1 Comp. 8673DA 8673D100 8673D200	9.2:1 Comp. VT23623A VT23623B	10:1 Comp. 300175	C3143-EST (104mm)	(15-22) 35-0974	Complete Kit (06-14) 20004-K01 (Std. 102mm)	O/S +1mm 80-80431 Exhaust 80-80433	O/S +.001 80-80421	Hot Cams Camshaft (06-08) Stage 1 4064-1 Stage 2 4065-2 Stage 3 4091-3			Hot Rods HR8651	Wossner WR4031	Bearing / Seal Kit 49K053 <i>Used with Hot Rods HR4078</i>		
					102.00 102.01 103.00	Std. Std. .040	11:1 Comp. 01.2707A	11:1 Comp. 4903M10200 4903M10300	11:1 Comp. 8673DA 8673D100 8673D200	11:1 Comp. VT23548A	11:1 Comp. 300176		Complete w/oil seals (06-14) 37-1923	(15-22) 20004-K02 (Std. 102mm)	O/S +1mm 80-80434						Hot Rods Bottom End Kit CBK0114 (06-14) HR00112 (15-20) <i>Includes Crankshaft, Bearings Seals, Complete Gasket Set</i>		Bearing / Seal Kit 49K054 <i>Used when Rebuilding Crankshaft</i>	
					102.00 102.01 103.00	Std. Std. .040	(15-24) 10:1 Comp. 01.2714A 01.2714B	(15-24) 40119M10200 40119M10300	(15-24) 8980DA	(15-24) 10:1 Comp. VT23965A VT23965B	(15-24) 324101		(15-21) 37-1974		Valve Springs 80-80410									
					102.00 102.01 103.00	Std. Std. .040				11:1 Comp. VT23966A VT23966B	11:1 Comp. 324102				Cylinder Head Service Kit 80-82080 <i>Includes Std. Valves, Guides Spring Kit, Seals, Gaskets</i>									
Big Bore to 727cc 727cc 105mm 735cc 105.5mm 741cc 106mm <i>CYLINDER WORKS COMPLETE CYLINDER KIT INCLUDES CYLINDER, PISTON KIT, AND TOP END GASKETS.</i>		BB	YA-5609		105.00 105.50 106.00	.120 .140 .160				9.2:1 Comp. VT23626A	11:1 Comp. 284766 300181	C3144-EST (105.5mm)		Cylinder Works Big Bore Complete Kit Raptor 21004-K01 (727cc)										
Grizzly 700 2007-15 2019-24 Kodiak 700 2019-24 Rhino 700 2008-13 Viking 700 2014-24 (Cylinder No. 384) 686cc Liquid Cooled 102mm 4.016" <i>RESLEEVEING REQUIRED FOR OVERSIZES</i> <i>CYLINDER WORKS COMPLETE KIT INCLUDES CYLINDER, PISTON KIT AND TOP END GASKETS</i>		AC	YA-5609	5609K-3 (07-13) Grizzly Rhino	102.00 102.01 103.00	Std. Std. .040	9.1:1 Comp. 01.2706A 01.2706B	9.2:1 Comp. 4902M10200 4902M10300	11:1 Comp. 8673DA 8673D100 8673D200	9.2:1 Comp. VT23623A VT23623B	10:1 Comp. 300175	C3143-EST (104mm)	(14-24) 35-0974	Complete Kit (07-13) 20104-K01 (Std. 102mm)	O/S +1mm 80-80431 Exhaust 80-80433	O/S +.001 80-80421	Hot Cams Camshaft Grizzly (07-13) 4126-M (Mudbuster) 4127-1 (Stage 1) 4128-2 (Stage 2) Rhino 4129-2 (Stage 2) 4130-3 (Stage 2)	CC-2706	Hot Rods HR4079 (thru '22)	Pro-X 04907 Hot Rods HR8651	6308YA3	49-822349		
				5609K-2 (14-22) Grizzly Kodiak Viking	102.00 103.00 104.00	Std. .040 .080	11:1 Comp. 01.2707A	11:1 Comp. 4903M10200 4903M10300	11:1 Comp. 8673DA 8673D100 8673D200	11:1 Comp. VT23548A	11:1 Comp. 300176		Complete w/oil seals (07-13) Grizzly (08-13) Rhino (14-17) Viking 37-1941	(14-23) 20104-K02 (Std. 102mm)	O/S +1mm 80-80434						Hot Rods Bottom End Kit Grizzly (07-13) Rhino (08-13) Viking (14-20) CBK0015 <i>Includes Crankshaft, Bearings Seals, Complete Gasket Set</i>		Bearing / Seal Kit 49K054 <i>Used when Rebuilding Crankshaft</i>	
					102.00 102.01 103.00	Std. Std. .040	(14-15, 19-24) 10:1 Comp. 01.2714A 01.2714B	(14-15, 19-24) 40119M10200 40119M10300	(14-15, 19-24) 8980DA	(14-15, 19-24) 10:1 Comp. VT23965A VT23965B	(14-15, 19-24) 324101				Cylinder Head Service Kit 80-82080 <i>Includes Std. Valves, Guides Spring Kit, Seals, Gaskets</i>									
					102.00 102.01 103.00	Std. Std. .040				11:1 Comp. VT23966A VT23966B	11:1 Comp. 324102													
Big Bore to 727cc 727cc 105mm 735cc 105.5mm 741cc 106mm <i>CYLINDER WORKS COMPLETE KIT INCLUDES CYLINDER, PISTON KIT AND TOP END GASKETS.</i>		BB	YA-5609		105.00 105.50 106.00	.120 .140 .160				(07-13) 9.2:1 Comp. VT23626A	(07-13) 11:1 Comp. 284766 300181	C3144-EST (105mm)		Cylinder Works Big Bore Complete Kit Rhino Grizzly (07-13) 21104-K01 (727cc)										
					105.00	.120				(14-22) 10.1:1 Comp. 23967A				Grizzly (14-22) Kodiak, Viking 21104-K02 (727cc)										

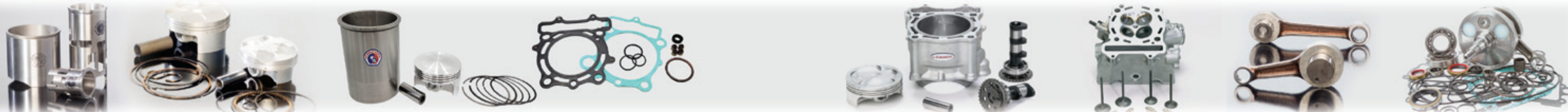

ATV-UTV ARCTIC CAT
ATV-UTV BOMBARDIER
ATV-UTV HONDA
ATV-UTV KAWASAKI
ATV-UTV KTM/KYMCO
ATV-UTV POLARIS
ATV-UTV SUZUKI
ATV-UTV YAMAHA
PERSONAL WATERCRAFT



MODEL
Engine Description
Cylinder I.D. (mm/in.)



SLEEVE

REBUILD KIT
Sleeve • Piston
Gasket • T.E. Bearing

BORE SIZE (mm)

PISTON SIZE

TOP END

TOP END

VALVE TRAIN

BOTTOM END

PRO-X PISTON

LAPC PISTON

WISECO PISTON

WOSSNER PISTON

VERTEX PISTON

JE PISTON

COMETIC GASKET

L.A. SLEEVE GASKET

CYLINDER AFTERMARKET KITS

VALVE / SPRING KIT

VALVE GUIDE

CAMSHAFT

CAM CHAIN

CRANKSHAFT

CON-ROD KIT

CRANK BEARING

ENGINE OIL SEAL KIT

YAMAHA ATV-UTV FOUR-STROKE (CONTINUED)

MODEL	Year	AC	YA-#	BORE SIZE (mm)	PISTON SIZE	PRO-X PISTON	LAPC PISTON	WISECO PISTON	WOSSNER PISTON	VERTEX PISTON	JE PISTON	COMETIC GASKET	L.A. SLEEVE GASKET	CYLINDER AFTERMARKET KITS	VALVE / SPRING KIT	VALVE GUIDE	CAMSHAFT	CAM CHAIN	CRANKSHAFT	CON-ROD KIT	CRANK BEARING	ENGINE OIL SEAL KIT		
Grizzly 700 Kodiak 700 Wolverine 700 (Cylinder No. 2MB) 708cc Single Liquid Cooled 103mm 4.055"	2016-18	AC	YA-5784	103.00	Std.				10.1:1 Comp. 40140M10300					Top End C3599-EST										
	2016-18			103.00	Std.																			
Wolverine 850 R-Spec 2018-24 847cc Twin Liquid Cooled 82mm 3.228"	2018-24	AC	YA-5827																					
	2021-24 999cc Liquid Cooled Mono-Block Twin 93mm 3.661"	AC	FL-5777	93.00	Std.					10.2:1 Comp. K4055DA-2 *													CC-2818	
				93.00	Std.				11.2:1 Comp. 40282M09300	11.2:1 Comp. K4056DA-2 *														
RMAX 1000 Big Bore Big Bore to 1035cc 96mm Big Bore to 1110cc** 98mm SPECIAL CLOSED DECK DUCTILE IRON SIAMESE FLANGED SLEEVES SOLD IN SET OF 2 SLEEVES SPECIAL CUSTOM MACHINING REQUIRED.	2021-24	AC	FL-5777CDSF																					
YZX1000R 998cc Triple Liquid Cooled 80mm 3.150" SPECIAL SIAMESED FLANGED SLEEVES SOLD IN SET OF 3 SLEEVES (2 END SLEEVES, 1 CENTER SLEEVE) SINGLE FLAT FLANGED END SLEEVE DOUBLE FLAT FLANGED CENTER SLEEVE	2016-24	AC	YA-5810	80.00	Std.				11.3:1 Comp. K8977DA * (* Set of 3)					Top End (16-21) C3617 (82.5mm)	Intake 80-81312 Exhaust 80-81316	Valve Guide IN/ EX 80-81320 O/S +.001 80-81321 Seals 71014-12			CC-2916					
				80.00	Std.			13:1 Comp. 40160M08000	13:1 Comp. K4048DA * (* Set of 3)															
			YA-5810CDX3	80.00	Std.			Turbo 9.5:1 Comp. 40161M08000	Turbo 9.5:1 Comp. K8978DA * (* Set of 3)		Turbo 9.5:1 Comp. 245192 * (*Set of 3)													
			YA-5810SF																					
	YA-5810DF													Cylinder Head Service Kit 80-82090 Includes Std. Valves, Guides Spring Kit, Seals, Gaskets										

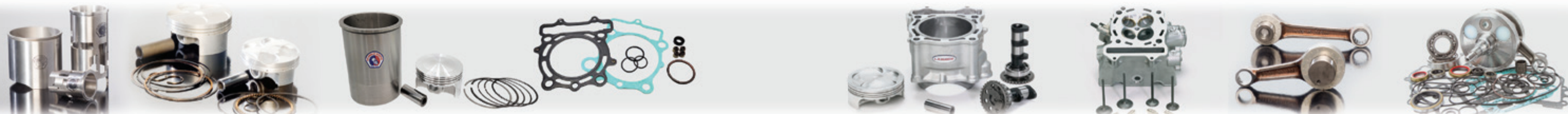

ATV-UTV ARCTIC CAT
ATV-UTV BOMBARDIER
ATV-UTV HONDA
ATV-UTV KAWASAKI
ATV-UTV KTM/KYMCO
ATV-UTV POLARIS
ATV-UTV SUZUKI
ATV-UTV YAMAHA
PERSONAL WATERCRAFT



ATV/UTV CYLINDER REBUILD KITS

Model	Year	Part #
HONDA 2-STROKE		
ATC-250R	1985-86	845K
TRX-250R	1986	845K
TRX-250R	1987-89	5032K
HONDA 4-STROKE		
TRX-500FA Foreman Rubicon 499cc Liquid-Cooled Single	2002-14	5504K
TRX-500 FE, FM Foreman 4x4 475cc Air Cooled Single	2005-11	5591K
TRX-450R, ER	2006-14	5537K-1
TRX-450R	2004-05	5561K
TRX-450 ES, S Foreman	1998-04	5365K
Fourtrax 420 Rancher	2009-18	5497K
Fourtrax 400 Rancher	2004-07	5630K
TRX-400 EX, X Sportrax	1999-14	5293K-1
TRX-400FW Foreman 4x4	1995-04	5286K
TRX-350 ES, TM Rancher	2000-09	5443K
Fourtrax 350	1986-89	952K
ATC-350X	1985-86	952K
TRX-300 EX, X (4 Valve)	1993-09	5062K
TRX-300 FW (2 Valve)	1988-00	5062K-1
TRX-250 EX, X, Sportrax	2001-21	5560K
Fourtrax 250 Recon	2002-09	5366K-1
TRX-250D Recon	1997-01	5366K
Fourtrax 250 X	1987-92	5028K
TRX-200D	1991-97	989K-2
TRX-200 SX	1986-88	989K
TRX-200	1984	103K
ATC-200X	1986-87	989K
ATC-200 E, ES, M	1981-86	103K
KAWASAKI 4-STROKE		
KFX-450R	2008-14	5675K
KFX-400	2003-06	5430K
KLF-300 Bayou	1985-05	986K
KEF-300 Lakota	1995-03	986K
KVF-300 Prairie	1999-03	986K
Mojave 250 KSF, KFX	1987-05	5018K
KLF-250 Bayou	2011-13	5506K
KLF-220 Bayou	1988-02	5063K
POLARIS 2-STROKE		
250 Trail Boss	1986-99	5168K
250 Trail Blazer	1990-06	5168K
250 Xplorer 4x4	2000-02	5168K
300 Xplorer, Xpress	1994-99	5273K
350L Trail Boss	1990-94	5171K
400L Trail Blazer, Scrambler, Xplorer	1994-03	5274K
SUZUKI 2-STROKE		
LT-500R J,K,L	1988-90	5073K
LT-500R J,K,L (Heavy sleeve repairs broken cylinder)		5073K-1
LT-500RH	1987	5021K
LT-500RH (Heavy sleeve repairs broken cylinder)		5021K-1
LT-250R J,K,L,M,N	1988-92	5064K
LT-250RH	1987	5020K
LT-250RG	1986	988K
LT-250RF	1985	942K

Model	Year	Part #
SUZUKI 4-STROKE		
LT-R450 Quadracer	2006-11	5625K
LT-Z400 QuadSport	2002-14	5430K
LTA, LTF-400 Eiger	2002-17	5512K
King Quad 400	2008-22	5512K-1
LTF-300 King Quad	1991-02	5136K
LT-230	1985-94	866K
YAMAHA 2-STROKE		
Banshee 350 (Rebuilds 2 Cylinders)	1987-06	5023K
Tri-Z 250	1985-89	879K
Blaster 200 (Heavy sleeve repairs broken cylinder)	1988-06	5035K 5035K-1
YAMAHA 4-STROKE		
Raptor 700R (Cyl. No. 1S3)	2015-21	5609K-1
Raptor 700R (Cyl. No. 1S3)	2006-14	5609K
Rhino 700 (Cyl. No. 3B4)	2008-13	5609K-3
Viking 700 (Cyl. No. 3B4)	2014-22	5609K-2
Grizzly 700 (Cyl. No. 3B4)	2019-22	5609K-2
Grizzly 700 (Cyl. No. 3B4)	2014-15	5609K-2
Grizzly 700 (Cyl. No. 3B4)	2007-13	5609K-3
Kodiak 700 (Cyl. No. 3B4)	2019-22	5609K-2
YFM-660 Grizzly	2002-08	7018K-1
YFM-660 Raptor	2001-06	7018K
YFZ-450R (Cyl. No. 2S2)	2009-22	5627K-1
YFZ-450R (Cyl. No. 5TA)	2004-13	5495K
Grizzly 450 (Cyl. No. 5ND)	2007-14	5513K
Kodiak 450 (Cyl. No. 5ND)	2018-21	5513K
Kodiak 450 (Cyl. No. 5ND)	2003-06	5513K
Rhino 450 (Cyl. No. 5ND)	2006-09	5513K
Wolverine 450 (Cyl. No. 5ND)	2006-10	5513K
Grizzly 400 (Cyl. No. 5GH)	2007-08	5425K
Kodiak 400 (Cyl. No. 5GH)	2000-06	5425K
Kodiak 400	1993-99	5231K
Big Bear 400	2000-12	5231K
YFM-350 Grizzly	2007-14	5024K
YFM-350 Raptor	2005-13	5024K
YFM-350 Bruin	2004-06	5024K
YFM-350 Wolverine	1995-09	5024K
YFM-350 Warrior	1987-05	5024K
YFM-350 Big Bear	1987-99	5024K
BW-350	1987-88	5024K
Raptor 250	2008-13	5679K
YFM-250 Big Bear	2007-09	5101K
YFM-250 Bruin	2005-06	5101K
YFM-250 Bear Tracker	1999-04	5101K
YFB-250 Timberwolf	1990-00	5101K



WATERCRAFT





PERSONAL WATERCRAFT SLEEVES

MODEL Cyl. I.D. MM/Inches	★	SLEEVE	BORE SIZE	PISTON SIZE	PRO-X PISTON	WISECO PISTON	WOSSNER PISTON	T.E. BEARING	GASKET	CRANKSHAFT PARTS
------------------------------	---	--------	--------------	----------------	--------------	---------------	-------------------	-----------------	--------	---------------------

HONDA 4-STROKE

Aqua Trax F12 1235cc 79mm	2002-07 Inline 4-Cyl. 3.110"	CI	H-5853							
--	---	----	---------------	--	--	--	--	--	--	--

KAWASAKI JET SKI 2-STROKE

JS-300 Single 76mm <i>CRANKCASE CLEAN-UP REQUIRED FOR PISTON 77.50MM AND LARGER</i>	1986-93 2.992"	CS/MO	KA-951H	76.00 76.50 77.00 77.50 78.00	Std. .020 .040 .060 .080		549M07600 549M07650 549M07700 549M07750 549M07800	6029DA 6029D050 6029D100 6029D150 6029D200	01337	Top End Vertex 610100	Crank Bearing 6305C3
JS-440 Aluminum Twin Cylinder 68mm	1976-80 2.677"	RS/MO	KA-630	68.00 68.50 69.00 69.50 70.00	Std. .020 .040 .060 .080	4458	2084M06850 2084M06900 2084M06950	6025D050 6025D100 6025D150	01312	Top End Vertex 610101	Crank Bearing 6206NR (MAG & PTO) 6305NR (Inner # 1&2) Oil Seal Set 091572
JS-440 Iron Twin Cylinder 68mm	1981-92 2.677"	CC/L	KA-835	68.00 68.50 69.00 69.50 70.00	Std. .020 .040 .060 .080	4458	2084M06850 2084M06900 2084M06950	6025D050 6025D100 6025D150	01312	Top End Cometic C6002 Vertex (81-88) 610101 (89-92) 610102	Crank Bearing 6206NR (MAG & PTO) 6305NR (Inner # 1&2) Oil Seal Set 091572
JS-550 Twin 75mm <i>CRANKCASE CLEAN-UP REQUIRED FOR PISTON 76.50MM AND LARGER</i>	1982-85 2.952"	CS/L	KA-836	75.00 75.50 76.00 76.50 77.00	Std. .020 .040 .060 .080		516M07500 516M07550 516M07600 516M07650 516M07700	6015DA 6015D050 6015D100 6015D150 6015D200	01312	Top End Vertex 610103	Crank Bearing 6206NR (MAG & PTO) 6305NR (Inner # 1&2) Oil Seal Set 091572
JS-550 Twin Iron Cylinder 75mm <i>CRANKCASE CLEAN-UP REQUIRED FOR PISTON 76.50MM AND LARGER</i>	1986-90 2.952"	CC/L	KA-5033	75.00 75.50 76.00 76.50 77.00	Std. .020 .040 .060 .080		516M07500 516M07550 516M07600 516M07650 516M07700	6015DA 6015D050 6015D100 6015D150 6015D200	01312	Top End Vertex 610103	Crank Bearing 6206NR (MAG & PTO) 6305NR (Inner # 1&2) Oil Seal Set 091572
JS-550SX Reed Twin 75mm <i>CRANKCASE CLEAN-UP REQUIRED FOR PISTON 76.50MM AND LARGER</i>	1991-95 2.952"	CI/L	KA-5135	75.00 75.50 76.00 76.50 77.00	Std. .020 .040 .060 .080		608M07500 608M07550 608M07600 608M07650		01312	Top End Vertex 610402	Crank Bearing 6206NR (MAG & PTO) 6305NR (Inner # 1&2) Oil Seal Set 091576
Jet Ski 550 PJS Cylinder Aluminum Twin Reed Cylinder 75mm	2.952"	RS/MO	KA-5234								

PERSONAL WATERCRAFT SLEEVES



WATERCRAFT

MODEL Cyl. I.D. MM/Inches	★	SLEEVE	BORE SIZE	PISTON SIZE	PRO-X PISTON	WISECO PISTON	WOSSNER PISTON	T.E. BEARING	GASKET	CRANKSHAFT PARTS
KAWASAKI JET SKI 2-STROKE (CONTINUED)										
JS-650, JL, JF Twin 1986-96 76mm 2.992" <i>CRANKCASE CLEAN-UP REQUIRED FOR PISTON 77.50MM AND LARGER</i>	CS	KA-999	76.00 76.50 77.00 77.50 78.00	Std. .020 .040 .060 .080		549M07600 549M07650 549M07700 549M07750 549M07800	6029DA 6029D050 6029D100 6029D150 6029D200	01337	Top End Cometic C6005 Vertex 610104	Con-Rod Kit 01573 Crank Bearing 6306C3 (MAG & PTO) 6306C3 (Inner #1) 6306NR (Inner #2) Oil Seal Set 42.4505
JS-750SX Twin 1992-95 A1, A2, A3, A4 JS-750SS A1, A2 1992-93 80mm 3.150" <i>TOP SLEEVE TO TOP EXHAUST 1.693" SPECIAL HEAVY SLEEVE 3.600" O.D.</i>	CI CS/MO	KA-5166 KA-5166H	80.00 80.50 81.00 81.50 82.00	Std. .020 .040 .060 .080		813M08000 813M08050 813M08100 813M08150 813M08200	6006DA 6006D050 6006D100 6006D150 6006D200	01320 (20mm)	Top End Vertex 610403 Cometic C6043 (83mm)	Crank Bearing 6306C3 (MAG & PTO) 6306C3 (Inner #1) 6306NR (Inner #2) Oil Seal Set 42.4505
JH-750 Twin 1993-95 SSxi B1, B2, B3 JH-750 SS A3, A4 1994-95 JH-750 XiR DI 1994 JT-750 ST, A1, A1A, A2 1994-95 Cylinder No. 22, 30 80mm 3.150" <i>TOP SLEEVE TO TOP EXHAUST 1.614" SPECIAL HEAVY SLEEVE 3.600" O.D.</i>	CI CS/MO	KA-5567 KA-5567H	80.00 80.50 81.00 81.50 82.00	Std. .020 .040 .060 .080		813M08000 813M08050 813M08100 813M08150 813M08200	6006DA 6006D050 6006D100 6006D150 6006D200	01320 (20mm)	Top End Vertex 610403 Cometic C6043 (83mm)	Crank Bearing 6306C3 (MAG & PTO) 6306C3 (Inner #1) 6306NR (Inner #2) Oil Seal Set 42.4505
JH-750 Twin 1995-97 Zxi C1, C2, C3 JH-750 1996-97 SSxi F1, F2, SS E1, E2 JH-750 Xi Sport G1, G2 1998-99 JS-750 SXi B1, B2 1995-96 JS-750 1998-02 SXi C1, C2, C3, C4, C5 JT-750 1995-98 STS B1, B2, B3, STX C1 80mm 3.150" Cylinder No. 24, 31 and 49 <i>Top Sleeve to Top Exhaust 1.535"</i> Cylinder No. 29 <i>Top Sleeve to Top Exhaust 1.560"</i>	CS/MO CI/L CS/MO	KA-5280H KA-5280 KA-5685H	80.00 80.50 81.00 81.50 82.00	Std. .020 .040 .060 .080	4490 4492 4494 4496	809M08000 809M08050 809M08100 809M08150 809M08200	6007DA 6007D050 6007D100 6007D150 6007D200	01326 (22mm)	Top End Vertex 610403 Cometic C6043 C6126 (ZXi 95-97) (SXi 98-02) (STX 98)	Con-Rod Kit HR8131 Crank Bearing 6306C3 (MAG & PTO) 6306C3 (Inner #1) 6306NR (Inner #2) Oil Seal Set 42.4505
800 SX-R 2003-11 782cc Twin 82mm 3.228" <i>SPECIAL HEAVY O.D. SLEEVE REPAIRS BROKEN CYLINDER SKIRTS</i>	CI CS/MO	KA-5496 KA-5496H	82.00 82.50 83.00	Std. .020 .040	4510 4512 4514	837M08200 837M08250	6010DA 6010D050 6010D096	01326 (22mm)	Top End Vertex 610409 Cometic C6126	Con-Rod Kit HR8131 Crank Bearing 6306C3 (MAG & PTO) 6306C3 (Inner #1) 6306NR (Inner #2) Oil Seal Set 42.4505



PERSONAL WATERCRAFT SLEEVES

MODEL Cyl. I.D. MM/Inches	★	SLEEVE	BORE SIZE	PISTON SIZE	PRO-X PISTON	WISECO PISTON	WOSSNER PISTON	T.E. BEARING	GASKET	CRANKSHAFT PARTS
KAWASAKI JET SKI 2-STROKE (CONTINUED)										
JH-900, JS-900, JT-900 1995-06 891cc Triple 73mm 2.874" <i>SPECIAL HEAVY O.D. SLEEVE REPAIRS BROKEN CYLINDER SKIRTS</i>	CI	KA-5283	73.00	Std.		659M07300	6009DA	01320	Top End Vertex 610404	Crank Bearing 5207-1LT (Mag Side) 6207NLT (Inner #1) 82A844A (Inner #2,3,4) 83A948 (PTO Side) Oil Seal Set 42.4519
				73.50	.020	4502	659M07350	6009D050		
			73.75	.030	4503					
			74.00	.040	4504	659M07400	6009D100			
			74.25	.050	4505					
			74.50	.060		659M07450	6009D150		Cometic C6118	
	CS	KA-5283H								
JH-1100, JT-1100 1996-03 ULTRA 130 D.I. 2001-04 1071cc Triple 80mm 3.150" <i>SPECIAL HEAVY O.D. SLEEVE REPAIRS BROKEN CYLINDER SKIRTS</i>	CI	KA-5303	80.00	Std.	4490	809M08000	6007DA	01326 (22mm)	Top End Vertex 610405	Crank Bearing 5207-1LT (Mag Side) 6207NLT (Inner #1) 82A844A (Inner #2,3,4) 83A948 (PTO Side) Oil Seal Set 42.4519
				80.50	.020	4492	809M08050	6007D050		
			81.00	.040	4494	809M08100	6007D100			
			81.50	.060	4496	809M08150	6007D150		Cometic C6145 (81mm)	
			82.00	.080		809M08200	6007D200			
	CS/MO	KA-5303H								
JH-1200, ULTRA 150 1999-05 STX-R 1200 2002-05 1176cc Triple 80mm 3.150" <i>RESLEEVEING REQUIRED FOR OVERSIZES</i>	AC	KA-5415	80.00	Std.	4520A	749M08000	6013DA	B1075	Top End Vertex 610410	
				80.01	Std.	4520B				
			80.50	.020		749M08050	6013D050			
			81.00	.040			6013D100		Cometic C6202 (81mm)	

KAWASAKI JET SKI 4-STROKE										
JT-1200 STX-12F 2003-07 1199cc Inline 4-Cyl. 83mm 3.267"	AC	KA-5433							Top End Vertex 610417	
STX-15F 2004-19 ULTRA X, LX 2007-21 SX-R JS-1500 2017-23 STX-160 X, LX JT-1500 2020-23 1498cc Inline 4-Cyl. 83mm 3.267" <i>NOTE: Cylinder Height 4.300"</i>	AC	KA-5565	83.00	Std.	10.6:1 Comp. 4554A	10.6:1 Comp. 40052M08300	12.5:1 Comp. 6517DA		Top End Vertex 610417	
				83.01	Std.	4554B		6517DB		
ULTRA 250X, LX 2007-08 ULTRA 260X, LX 2009-10 1498cc Inline 4-Cyl. 83mm 3.267" <i>NOTE: Cylinder Height 4.560"</i>	AC	KA-5776	83.00	Std.	Ultra 260 7.8:1 Comp. 4559B	Ultra 260 8.4:1 Comp. 40048M08300	Ultra 260 8.4:1 Comp. 6506DA		Top End Vertex 610419	
ULTRA 300X, LX 2011-13 1498cc Inline 4-Cyl. 83mm 3.267" <i>NOTE: Cylinder Height 4.560"</i>	AC	KA-5776	83.00	Std.	8.4:1 Comp. 4561B		8.4:1 Comp. 6510DA		Top End Vertex 610420	
ULTRA 310 R, X, LX 2014-23 1498cc Inline 4-Cyl. 83mm 3.267" <i>NOTE: Cylinder Height 4.560"</i>	AC	KA-5776	83.00	Std.		8.2:1 Comp. 40203M08300				

PERSONAL WATERCRAFT SLEEVES



WATERCRAFT

MODEL Cyl. I.D. MM/Inches	★	SLEEVE	BORE SIZE	PISTON SIZE	PRO-X PISTON	WISECO PISTON	WOSSNER PISTON	T.E. BEARING	GASKET	CRANKSHAFT PARTS
SEA DOO 2-STROKE										
SEA DOO 580 TWIN 1988 SEA DOO 580 TWIN 1989-96 76mm 2.992"	RS/L RS/L	FL-5102 FL-5125	76.00 76.50 77.00 77.50	Std. .020 .040 .060	8026	734M07600 734M07650 734M07700	6008DA 6008D050 6008D100	01181	Top End Vertex 610200 (White Engine) 610110 (88-91) (Yello Eng.)	Con-Rod Kit 02522 Crank Bearing 6206NRC4 (Mag #1 & 2) 6305NR (Inner #1) 6206NR (Inner #2) Oil Seal Set 42.5506
SEA DOO 650 TWIN 1993-95 78mm 3.071"	RS/L	FL-5244	78.00 78.50 79.00 79.50	Std. .020 .040 .060		633M07800 633M07850 633M07900 633M07950	6022DA 6022D050 6022D100 6022D150	01322	Top End Cometic C6056	Crank Bearing 6206NRC4 (Mag #1 & 2) 6206NRC4 (Inner #1 & 2) Oil Seal Set 42.5507
SEA DOO 650 TWIN 1993-95 78mm 3.071"	RS/L	FL-5244	78.00 78.50 79.00 79.50	Std. .020 .040 .060		633M07800 633M07850 633M07900 633M07950	6022DA 6022D050 6022D100 6022D150	01322	Top End Cometic C6056	Crank Bearing 6206NRC4 (Mag #1 & 2) 6206NRC4 (Inner #1 & 2) Oil Seal Set 42.5507
SEA DOO 750 (720) 1995-05 GS, GSI, HX, GTI, GTS, XP 718cc Twin 82mm 3.228"	RS/L	FL-5268	82.00 82.50 83.00 83.50 84.00	Std. .020 .040 .060 .080			6002DA 6002D050 6002D100 6002D150 6002D200	01328	Top End Vertex 610204 Cometic C6119	Con-Rod Kit 02534 (PTO) 02536 (MAG) Crank Bearing 6206NRC4 (Mag #1 & 2) 6206NRC4 (Inner #1 & 2) Oil Seal Set 42.5507
SEA DOO 785 1995-05 GTI, GTX, GSX, SPX, XP 782cc Twin 82mm 3.228"	RS	FL-5290	82.00 82.50 83.00 83.50 84.00	Std. .020 .040 .060 .080	8050 8052 8054 8056	778M08200 778M08250 778M08296	6001DA 6001D050 6001D100 6001D150 6001D200	01328	Top End Vertex 610205 Cometic C6154	Con-Rod Kit 02537 Oil Seal Set 092535
SEA DOO 785 RFI 1998-05 GTI, GTX, GSX, SPX, XP RFI DIRECT INJECT MOTOR 782cc Twin 82mm 3.228"	RS	FL-5583	82.00 82.50 83.00 83.50 84.00	Std. .020 .040 .060 .080	8050 8052 8054 8056	778M08200 778M08250 778M08296	6001DA 6001D050 6001D100 6001D150 6001D200	01328	Top End Vertex 610209 Cometic C6154	Con-Rod Kit 02537 Oil Seal Set 092535
SEA DOO 951 1997-06 GSX LTD, XP, GTX, LRV, RX 951cc Twin 88mm 3.464"	RS	FL-5322	88.00 88.50 89.00 89.50 90.00	Std. .020 .040 .060 .080	8060 8062 8064 8066	716M08800 716M08850 716M08894 716M08950 716M09000	6011DA 6011D050 6011D100 6011D150 6011D200	01242	Top End Vertex 610206 Cometic C6157	Con-Rod Kit 02542 Oil Seal Set 42.5515
SEA DOO 951 DI 2000-07 GTX, LRV, RX, XP, 3D DIRECT INJECT MOTOR 951cc Twin 88mm 3.464"	RS	FL-5578	88.00 88.50 89.00 89.50 90.00	Std. .020 .040 .060 .080	8060 8062 8064 8066	716M08800 716M08850 716M08894 716M08950 716M09000	6011DA 6011D050 6011D100 6011D150 6011D200	01242	Top End Vertex 610210	Con-Rod Kit HR8628 Oil Seal Set 42.5515



PERSONAL WATERCRAFT SLEEVES

MODEL Cyl. I.D. MM/Inches	★	SLEEVE	BORE SIZE	PISTON SIZE	PRO-X PISTON	WISECO PISTON	WOSSNER PISTON	T.E. BEARING	GASKET	CRANKSHAFT PARTS
SEA DOO 4-STROKE										
900 HO ACE 2014-24 899cc Mono-Block Triple 74mm 2.913"	AC	FL-5809	74.00 74.50 75.00	Std. .020 .040			9.5:1 Comp. 6513DA 6513D050 6513D100		Top End Vertex 610216	
<i>RESLEEVEING REQUIRED FOR OVERSIZES</i>										
1503, 1500 HO ACE 2004-16 4-TEC, GTI 130/155, GTX 130/155, RXP RXP-X 255, RXT, RXT-X 260, WAKE 1494cc Triple 100mm 3.937"	CI	FL-5500	100.00 100.50 101.00	Std. .020 .040	8.4:1 comp. 01.5594.000 01.5594.050 01.5594.100	8.4:1 Comp. 40038M10000 40038M10050 40038M10100	9.5:1 Comp. 6503DA 6503D050 6503D100		Top End (04-15) Vertex 610214	
1503, 1500 ACE 2017-19 GTI, GTR, GTS 130, GTX 155/230/260, RXT 230/260 1494cc Triple, Plasma Coated Cylinder 100mm 3.937"	AC	FL-5500	100.00	Std.			9.5:1 Comp. 6503DA		Top End (18-19) Vertex 610217	
1630 ACE 2016-23 GTI, GTR, GTX, 170 / 230 1630cc Triple 100mm 3.937"	AC	FL-5822								
1630 ACE 2016-23 GTX, RXP, RXT 300 1630cc Triple 100mm 3.937"	AC	FL-5822	100.00 100.01 100.50 101.00	Std. Std. .020 .040	8.4:1 comp. 5596A 5596B	8.4:1 comp. 40270M10000	9.5:1 Comp. 6512DA 6512D050 6512D100		Top End Vertex 610217	
<i>RESLEEVEING REQUIRED FOR OVERSIZES</i>										

YAMAHA 2-STROKE										
650 Wave Runner, LX 1991-93 Wave Runner III 1990-95 Wave Runner VXR 1991-92 (to 816999) 633cc Twin 77mm 3.031"	RS/L	YA-5176	77.00 77.50 78.00 78.50 79.00	Std. .020 .040 .060 .080			6016DA 6016D050 6016D100 6016D150 6016D200	01252	Top End Vertex 610119 Pro-X 35-2506	Con-Rod Kit 02531NP (W/O Crank Pin) 02531 (W/ Crank Pin) Crank Bearing MAG - N/A PTO - N/A 6207YR (Inner #1 & 2) Oil Seal Set 42.2510
650 Super Jet 1990-93 Wave Runner VXR 1992-95 (from 817001) Wave Runner III 1996 633cc Twin 77mm 3.031"	RS/L	YA-5139	77.00 77.50 78.00 78.50 79.00	Std. .020 .040 .060 .080			6016DA 6016D050 6016D100 6016D150 6016D200	01252	Top End Vertex 610119 Pro-X 35-2506	Con-Rod Kit 02531NP (W/O Crank Pin) 02531 (W/ Crank Pin) Crank Bearing MAG - N/A PTO - N/A 6207YR (Inner #1 & 2) Oil Seal Set 42.2510

PERSONAL WATERCRAFT SLEEVES



MODEL Cyl. I.D. MM/Inches	★	SLEEVE	BORE SIZE	PISTON SIZE	PRO-X PISTON	WISECO PISTON	WOSSNER PISTON	T.E. BEARING	GASKET	CRANKSHAFT PARTS
YAMAHA 2-STROKE (CONTINUED)										
700 Super Jet 1994-20 Wave Blaster 1993-97 Wave Raider 1996-97 Wave Runner Pro VXR 1993-94 Wave Runner III GP 1995-97 FX-700 1994-95 Cylinder No. 61X 701cc Twin 81mm 3.188"	RS	YA-5187	81.00 81.25 81.50 82.00 82.50 83.00	Std. .010 .020 .040 .060 .080	7090 7091 7092 7094 7096 7098	790M08100 790M08150 790M08200 790M08250 790M08300	6005DA 6005D050 6005D100 6005D150 6005D200	01252	Top End (SJ 94-95) (WB 93-96) (WR 94-97) Vertex 610601 (SJ 96-20) 610605	Con-Rod Kit 02531NP (W/O Crank Pin) 02531 (W/ Crank Pin) Crank Bearing MAG - N/A PTO - N/A 6207YR (Inner #1 & 2) Oil Seal Set 42.2510
700 Wave Raider DX 1995 XL700 Wave Runner 1999-05 700 Wave Venture 1995-98 Cylinder No. 62T 701cc Twin 81mm 3.188"	RS	YA-5284	81.00 81.25 81.50 82.00 82.50 83.00	Std. .010 .020 .040 .060 .080	7090 7091 7092 7094 7096 7098	790M08100 790M08150 790M08200 790M08250 790M08300	6005DA 6005D050 6005D100 6005D150 6005D200	01252	Top End Vertex 610602	Con-Rod Kit 02531NP (W/O Crank Pin) 02531 (W/ Crank Pin) Crank Bearing MAG - N/A PTO - N/A 6207YR (Inner #1 & 2) Oil Seal Set 42.2510
700 Big Bore 754cc to 790cc Super Jet, Wave Blaster Wave Raider, Wave Runner, XL700, FX700	RS/MO	YA-5187B	84.00 84.50 85.00 85.50 86.00	754cc 763cc 771cc 780cc 789cc		790M08400 757M08450 757M08500 757M08550 757M08600	6005D300	01252	Top End Cometic C6149 (85mm)	
GP760 1996-00 Wave Blaster, Wave Runner Wave Venture, XL760 754cc Twin 84mm 3.307"	RS	YA-5304	84.00 84.25 84.50 85.00 85.50 86.00	Std. .010 .020 .040 .060 .080	7110 7111 7112 7114 7116	757M08400 757M08450 757M08500 757M08550 757M08600	6012DA 6012D050 6012D100 6012D150 6012D200	01252	Top End Vertex 610603 Cometic C6149 (85mm)	Con-Rod Kit 02531NP (W/O Crank Pin) 02531 (W/ Crank Pin) Oil Seal Set 42.2510

WATERCRAFT



PERSONAL WATERCRAFT SLEEVES

MODEL Cyl. I.D. MM/Inches	★	SLEEVE	BORE SIZE	PISTON SIZE	PRO-X PISTON	WISECO PISTON	WOSSNER PISTON	T.E. BEARING	GASKET	CRANKSHAFT PARTS
YAMAHA 2-STROKE (CONTINUED)										
GP800 R 1998-05 XL800 2000-01 XLT800 2002-04 Cylinder No. 66E00 784cc Twin 80mm 3.150"	AC	YA-5356	80.00 80.01 80.02 80.50 81.00	Std. Std. Std. .020 .040	7170A 7170B 7170C 7172	758M08000 758M08100	6004DA 6004D050 6004D100	B1074	Top End Vertex 610607 Pro-X 35-2518	Con-Rod Kit HR8606 Oil Seal Set 092543
1100 Wave Raider 1995-97 1100 Wave Venture 1051cc Triple 81mm 3.188"	RS	YA-5284	81.00 81.25 81.50 82.00 82.50 83.00	Std. .010 .020 .040 .060 .080	7090 7091 7092 7094 7096 7098 (Without Intake Hole)	791M08100 791M08150 791M08200 791M08250	6005DA 6005D050 6005D100 6005D150 6005D200 (Without Intake Hole)	01252	Top End Vertex 610604 Cometic C6121 (83mm)	Con-Rod Kit 02531NP (W/O Crank Pin) 02531 (W/ Crank Pin) Crank Bearing 6207YR (Inner #1,2,3,4) MAG - N/A PTO - N/A Oil Seal Set 42.2510
GP1200 Wave Runner 1997-99 XL1200 Wave Runner 1998 SUV1200 1999-04 1131cc Triple 84mm 3.307"	RS	YA-5349	84.00 84.25 84.50 85.00 85.50 86.00	Std. .010 .020 .040 .060 .080	7110 7111 7112 7114 7116	757M08400 757M08450 757M08500 757M08550 757M08600	6012DA 6012D050 6012D100 6012D150 6012D200	01252	Top end Vertex 610606 Cometic C6160 (86mm)	Con-Rod Kit 02531NP (W/O Crank Pin) 02531 (W/ Crank Pin) Crank Bearing 6207YR (Inner #1,2,3,4) MAG - N/A PTO - N/A Oil Seal Set 42.2510
GP1200, SUV1200 1997-04 Big Bore to 1185cc 86mm 3.386"	MO	YA-5349B	86.00	1185cc		757M08600	6012D200	01252	Top End Cometic C6160	
GP1200R 2000-02 XL 1200 LTD 1999-00 XLT 1000 2001-05 Cylinder No. 66V00 1176cc Triple 80mm 3.150"	AC	YA-5469	80.00 80.01 80.02 80.50 81.00	Std. Std. Std. .020 .040	7170A 7170B 7170C 7172	758M08000 758M08100	6004DA 6004D050 6004D100	B1074	Top End Vertex 610608 Pro-X 35-2515	Oil Seal Set 42.2520
GP 1300R 2003-08 Cylinder No. 60T00 1296cc Triple 84mm 3.307"	AC	YA-5502	84.00 84.01 84.02	Std. Std. Std.	7190A 7190B 7190C	857M08400	6003DA 6003DB 6003DC	B1074	Top End Vertex 610107	

PERSONAL WATERCRAFT SLEEVES



MODEL Cyl. I.D. MM/Inches	★	SLEEVE	BORE SIZE	PISTON SIZE	PRO-X PISTON	WISECO PISTON	WOSSNER PISTON	T.E. BEARING	GASKET	CRANKSHAFT PARTS
YAMAHA WAVE RUNNER 4-STROKE										
FX140, FX1000 Wave Runner FX Cruiser 998cc 74mm	2003-08 4-Cyl. 2.913"	AC CI	YA-5501 74.00 74.01 74.02	Std. Std. Std.	7200A 7200B 7200C	4707M07400	6501DA			
FX HIGH OUTPUT VX110, VX1100 1052cc 76mm	2003-08 2005-15 Inline 4-Cyl. 2.992"	AC	YA-5566 76.00 76.01	Std. Std.	11.4:1 Comp. 2905A 2905B	11.4: Comp. 40051M07600	11.4:1 Comp. 6509DA		Top End Vertex (VX1100) 610614	
TR-1 HIGH OUTPUT, VX1050 VX CRUISER, DELUXE, HO, LTD EX, EXR, DELUXE, SPORT, 1049cc 82mm	2016-24 Inline 4-Cyl. 3.228"	CI	YA-5802 82.00	Std.			11:1 Comp. 6516DA			
FX 1800 CRUISER FX, FZR, HO, SHO, SVHO, VXR 1812cc 86mm	2008-23 Inline 4-Cyl. 3.386"	AC	YA-5688 86.00 86.01 86.50	Std. Std. .020	(08-14) 8.6:1 Comp. 2909A 2909B	(Thru 2021) 8.6:1 Comp. 40280M08600	(Thru 2021) 8.6:1 Comp. 6505DA 6505D050			
GP-1800R SVHO 1812cc 86mm	2017-24 Inline 4-Cyl. 3.386"	AC	YA-5688 86.00	Std.		8.6:1 Comp. 40280M08600	11.4:1 Comp. 6509DA			

WATERCRAFT



DIRT BIKE CARBURETOR KITS



Shindy Carb Repair Kits are made in Japan using only the finest materials. Each kit rebuilds OEM carburetors. Included are main and pilot jets, jet needle sets, float valves, float chamber gaskets and O-rings. Idle screw sets, pilot screw sets and air screw sets also included if applicable.

HONDA DIRT BIKE

MODEL	YEAR	PART #
CRF50F	04-05	03-715
CRF50F	06-16	03-726
XR50R	00-03	03-715
Z50R	88-99	03-715
CRF70F	04-05	03-716
CRF70F	06-12	03-727
CT70	91-94	03-7A6
XR70R	97-03	03-716
CR80R	96-02	03-701
CRF80F	04-05	03-717
CRF80F	06-12	03-728
XR80R	87-03	03-717
CR85R	03-04	03-701
CR85R	05-07	03-706
CRF100F	04-05	03-718
CRF100F	06-16	03-729
XR100R	85-00	03-737
XR100R	01-03	03-718
CRF110F	13-18	03-7A7

MODEL	YEAR	PART #
CR125R	96-98	03-7A1
CR125R	00-01	03-702
CR125R	02-03	03-703
CR125R	04-07	03-707
CRF125F	14-18	03-7A2
CRF150F	03-05	03-719
CRF150F	06-17	03-730
CRF150R	07-09	03-739
XR200R	86-96	03-731
XR200R	98-02	03-732
CRF230F	03-05	03-720
CRF230F	06-19	03-733
CRF230L	08-09	03-742
CR250R	97-98	03-7A3
CR250R	99-00	03-704
CR250R	01-03	03-705
CR250R	04-07	03-708
CRF250R	04	03-709
CRF250R	05	03-710

MODEL	YEAR	PART #
CRF250R	06	03-736
CRF250R	07-08	03-711
CRF250X	04-06	03-723
CRF250X	07-12	03-740
XR250L	91-96	03-743
XR250R	86-95	03-734
XR250R	96-04	03-735
XR400R	96-97	03-7A4
XR400R	98-04	03-721
CRF450R	02-04	03-712
CRF450R	05-06	03-713
CRF450R	07-08	03-714
CRF450X	05-06	03-724
CRF450X	07-09	03-725
CR500R	91-01	03-7A5
XR600R	92-00	03-738
XR650L	93-16	03-741
XR650R	00-06	03-722

KAWASAKI DIRT BIKE

MODEL	YEAR	PART #
KX60	84-03	03-767
KX65	00-01	03-761
KX65	02-20	03-757
KX85	01-20	03-751
KE100	87-01	03-768
KX100	01-13	03-762
KLX110	02-05	03-759
KLX110	06-09	03-758
KX125	01-02	03-752

MODEL	YEAR	PART #
KX125	03-05	03-753
KLX140/L	08-20	03-760
KDX200	95-06	03-763
KDX220R	97-05	03-764
KL250	87-05	03-794
KL250G	00-03	03-795
KLX250S	06-07	03-796
KLX250S/SF	09-14	03-793
KX250	00-07	03-754

MODEL	YEAR	PART #
KX250F	04-08	03-755
KLX300R	97-07	03-765
KLX400R	03-04	03-808
KLX450R	08-09	03-769
KLX400SR	03-04	03-841
KX450F	06-08	03-756
KX500	97-03	03-766
KLR650	87-07	03-791
KLR650	08-18	03-792

* Parts included for two carburetors.



DIRT BIKE CARBURETOR KITS

KTM DIRT BIKE

MODEL	YEAR	PART #
250SX-F	05-10	03-901
250SXS-F	06-08	03-901
250XC/XC-W	06-14	03-903
250XC-F	07-09	03-901
250XCF-W	06-11	03-901
300XC-W	06-07	03-903
300XC-W	11-14	03-903
400EXC	04-05	03-904
EXC-G	06	03-902
400XC-W	07-10	03-902
450EXC/EXC-G	06-11	03-902
450EXC-G	03-05	03-904

MODEL	YEAR	PART #
450EXC-R	08	03-902
450MXC-G	03-05	03-904
450SMR	06-09	03-902
450SMR	12	03-902
450SX/SXS	03-05	03-905
450SX/SX-F	06-12	03-902
450SXS-F	07-08	03-902
450XC/XC-F	07-09	03-902
450XC-G/XC-W	06-11	03-902
450XCR-W	08	03-902
505SX-F	08	03-902
505XC-F	08-09	03-902

MODEL	YEAR	PART #
525EXC/EXC-G	06-07	03-902
525EXC-G	03-05	03-904
525MXC-G	03-05	03-904
525SMR	05	03-905
525SX	03-05	03-905
525SX	06	03-902
525XC/XC-W	06	03-902
530EXC/EXC-R	08-11	03-902
530XC-W	09-11	03-902
530XCR-W	08	03-902
540SXS	03-05	03-905
540SXS	06	03-902

SUZUKI DIRT BIKE

MODEL	YEAR	PART #
JR50	00-06	03-809
DR-Z70	08-18	03-810
DS80	83-00	03-811
JR80	01-04	03-811
RM85	02-09	03-801
DR-Z125/L	03-09	03-806
RM125	01-06	03-802
DR200SE	96-09	03-843
DR-Z250	01-05	03-807
RM250	01-08	03-803
RM-Z250	05-06	03-755
RM-Z250	07-09	03-804
DR350SE	90-99	03-844
DR-Z400/E	00-07	03-808
DR-Z400S	00-19	03-841
RM-Z450	05-07	03-805
DR650SE	96-17	03-842

YAMAHA DIRT BIKE

MODEL	YEAR	PART #
PW50	85-06	03-866
PW50	08-21	03-880
TT-R50E	06-09	03-867
TT-R50E	12-21	03-881
PW80	91-06	03-873
YZ80	97-01	03-851
YZ85	02-05	03-852
YZ85	06-18	03-857
TT-R90/E	00-05	03-874
TT-R90E	06-07	03-876
TT-R110E	08-21	03-882
TT-R125	00-05	03-875
TT-R125/L	06-07	03-868
TTR125/E/L/LE	08-21	03-883
YZ125	99-00	03-853
YZ125	01	03-878
YZ125	02-04	03-854
YZ125	05-08	03-858
TW200	87-00	03-891
TW200	01-21	03-892
TT-R225	00-04	03-877
XT225	92-00	03-877

MODEL	YEAR	PART #
XT225	01-07	03-893
TT-R230	05-20	03-869
TT-R250	00-06	03-886
WR250F	03-04	03-884
WR250F	05-09	03-870
XT250	08-12	03-894
YZ250	00-01	03-855
YZ250	02-06	03-856
YZ250	07-21	03-859
YZ250F	01-02	03-860
YZ250F	03-06	03-861
YZ250F	07-08	03-862
XT350	85-00	03-887
WR400F	00	03-888
YZ400F	98-99	03-879
WR426F	01-02	03-888
YZ426F	00-02	03-863
WR450F	03	03-885
WR450F	04-06	03-871
WR450F	07-09	03-872
YZ450F	03-04	03-864
YZ450F	05-09	03-865

* Parts included for two carburetors.

GAS GAS
HONDA
HUSQVARNA
KAWASAKI
KTM
SUZUKI
YAMAHA
DIRT BIKE SLEEVES
STREET BIKE SLEEVES
ACCESSORIES
TECHNICAL



ATV CARBURETOR REPAIR KITS

Shindy Carb Repair Kits are made in Japan using only the finest materials. Each kit rebuilds OEM carburetors. Included are main and pilot jets, jet needle sets, float valves, float chamber gaskets and O-rings. Idle screw sets, pilot screw sets and air screw sets also included if applicable.



HONDA

MODEL	YEAR	PART #
TRX90 FourTrax	93-98	03-041
TRX90 FourTrax	99-00	03-047
TRX90 SporTrax	01-05	03-047
TRX90 SporTrax	06	03-056
TRX90EX	07-08	03-056
TRX90X	09	03-056
TRX90X	12	03-056
TRX90X	13-20	03-058
ATC110	78-93	03-003
ATC110	84-85	03-024
ATC185	80	03-006
ATC185S	81-82	03-006
ATC185S	83	03-026
ATC200	81-82	03-006
ATC200	83	03-026
ATC200E	82-83	03-027
ATC200ES Big Red	84	03-027
ATC200M	84-85	03-027
ATC200S	84-86	03-007
ATC200X	83-85	03-008
ATC200X	86-87	03-009
TRX200	84	03-036
TRX200	91	03-032
TRX200D	92-93	03-033
TRX200D	94-96	03-034
TRX200SX FourTrax	86	03-057

MODEL	YEAR	PART #
TRX200SX FourTrax	87-88	03-010
ATC250ES Big Red	85	03-015
ATC250ES Big Red	86-87	03-028
ATC250R	81-82	03-012
ATC250R	83-84	03-013
ATC250R	85	03-014
ATC250SX	85	03-015
ATC250SX	86-87	03-028
TRX250 Fourtrax	85	03-016
TRX250 Fourtrax	86-87	03-017
TRX250 Recon	97-01	03-042
TRX250TE/TM Recon	02	03-042
TRX250EX SporTrax	01-05	03-042
TRX250EX SporTrax	06-08	03-052
TRX250TE Recon ES	02-05	03-042
TRX250TE Recon ES	06-11	03-051
TRX250TE/TM	12-13	03-051
TRX250TE/TM	16-21	03-060
TRX250TM Recon	02-05	03-042
TRX250TM Recon	06-11	03-051
TRX250R Fourtrax	86-87	03-018
TRX250R Fourtrax	88	03-019
TRX250X Fourtrax	87-92	03-020
TRX250X Recon	99	03-042
TRX250X	09-12	03-052
TRX250X	16-21	03-059

MODEL	YEAR	PART #
TRX300 FourTrax	88-90	03-021
TRX300 FourTrax	91-92	03-029
TRX300 FourTrax	93-00	03-031
TRX300EX	06-08	03-038
TRX300EX FourTrax	93-00	03-038
TRX300EX SporTrax	01-05	03-038
TRX300FW	88-90	03-021
TRX300FW 4x4	91-92	03-029
TRX300FW 4x4	93-00	03-031
TRX350 FourTrax	86-87	03-023
TRX350 Foreman	88	03-023
TRX350 Foreman	87	03-023
TRX350FE Rancher ES	00-03	03-039
TRX350FE Rancher ES	04-06	03-053
TRX350FM Rancher	00-03	03-039
TRX350FM Rancher ES	04-06	03-053
TRX350TE Rancher ES	00-03	03-039
TRX350TE Rancher ES	04-06	03-053
TRX350TM Rancher	00-03	03-039
TRX350TM Rancher	04-06	03-053
TRX400EX FourTrax	99-00	03-044
TRX400EX SporTrax	01-04	03-044
TRX400EX SporTrax	05	03-054
TRX400EX	06-08	03-054
TRX400FA Rancher	04-07	03-045
TRX400FGA Rancher	04-07	03-045

MODEL	YEAR	PART #
TRX400FW Foreman	95-03	03-037
TRX400X	12-14	03-054
TRX450ER	06-09	03-050
TRX450ER	12-14	03-050
TRX450ES	98-01	03-040
TRX450FE Foreman ES	02-04	03-040
TRX450FM Foreman S	02-04	03-040
TRX450R	04-05	03-049
TRX450R	06-09	03-050
TRX450S	98-01	03-040
TRX500FA Rubicon	01-04	03-043
TRX500FA Rubicon	05-09	03-055
TRX500FA Rubicon	11-12	03-055
TRX500FE Foreman ES	05-11	03-048
TRX500FGA Rubicon	04	03-043
TRX500FGA Rubicon	05-08	03-055
TRX500FM Foreman	05-11	03-048
TRX500FPA Rubicon	09-12	03-055
TRX500FPE Foreman	07-11	03-048
TRX500FPM Foreman	07-11	03-048
TRX500TM	05-06	03-048
TRX650FA Rincon	03-05	03-046
TRX650FGA Rincon	04-05	03-046

KAWASAKI

MODEL	YEAR	PART #
KSF50 KFX	03-06	03-222
KSF50 KFX	07-21	03-124
KSF80 KFX	03-06	03-114
KSF90 KFX	07-09	03-117
KSF90 KFX	10-21	03-125
KLF220 Bayou	88-02	03-101
KLF250 Bayou	03-06	03-111
KLF250 Bayou	07-11	03-120
KSF250 KFX Mojave	87-04	03-106

MODEL	YEAR	PART #
KEF300 Lakota	95-03	03-118
KLF300 Bayou	86-88	03-103
KLF300 Bayou	89-04	03-104
KLF300 Bayou 4x4	89-04	03-105
KVF300 Brute Force	12-18	03-121
KVF300 Brute Force	20	03-121
KVF300 Prairie	99-02	03-109
KVF360 Prairie	03-09	03-112
KVF360 Prairie	10-13	03-112

MODEL	YEAR	PART #
KAF400 Mule 600	07-16	03-122
KAF400 Mule 610 4x4	07-16	03-122
KAF400 Mule SX	17-19	03-122
KLF400 Bayou	93-95	03-107
KLF400 Bayou 4x4	96-99	03-108
KSF400 KFX400	03-06	03-221
KVF400 Prairie	99-02	03-110
KAF620A Mule 2510	97-00	03-123
KAF620B Mule 2520	97-00	03-123

MODEL	YEAR	PART #
KAF620C Mule 2500	97-00	03-123
KVF650 Prairie	02	03-113*
KVF650 Prairie 4x4	03	03-113*
KVF650 Brute Force	05	03-113*
KVF650 Brute Force 4x4	06-13	03-113*
KSV700 KFX	04-09	03-116*
KVF700 Prairie 4x4	04-06	03-113*
KVF750 Brute Force	05-07	03-119*

* Parts included for two carburetors.



ATV CARBURETOR REPAIR KITS

POLARIS

MODEL	YEAR	PART #
Outlaw 50	08-13	03-419
Predator 50	05-06	03-418
Predator 50	07	03-419
Outlaw 90	07-08	03-422
Outlaw 90	09-14	03-420
Predator 90	03	03-433
Predator 90	04-06	03-421
Scrambler 90	02	03-433
Sportsman 90	02-03	03-433
Sportsman 90	04-06	03-421
Sportsman 90	08	03-422
Sportsman 90	09-14	03-420
Ranger RZR170	09-14	03-431
Phoenix 200	05-14	03-411
Trail Blazer 250	90-95	03-401
Trail Blazer 250	96-00	03-405
Trail Blazer 250	03-06	03-405
Trail Boss 250	89-99	03-401

MODEL	YEAR	PART #
Trail Boss 250 2x4	89-93	03-401
Trail Boss 250 4x4	89-93	03-401
Hawkeye 300 2x4	06-09	03-427
Hawkeye 300 4x4	06-07	03-427
Sportsman 300	08-10	03-427
Magnum 325 2x4	00-02	03-423
Magnum 325 4x4	00-02	03-423
Magnum 330 2x4	00-01	03-423
Magnum 330 2x4	03-05	03-409
Magnum 330 4x4	03-06	03-409
Trail Blazer 330	08-13	03-409
Trail Boss 330	03-13	03-409
Ranger 400	10-14	03-426
Sportsman 400	01-02	03-412
Sportsman 400	03-05	03-413
Sportsman 400	10-14	03-414
Sportsman 400 HO	08-09	03-414
Sportsman 450	06-07	03-414

MODEL	YEAR	PART #
Outlaw 500	06-07	03-415
Predator 500	03-07	03-415
Ranger 500 2x4	04-09	03-425
Ranger 500 4x4	04-07	03-425
Scrambler 500 2x4	01-02	03-408
Scrambler 500 4x4	98-02	03-408
Scrambler 500 4x4	03-09	03-410
Scrambler 500 4x4	10-12	03-432
Scrambler 500 HO	01-13	03-410
Sportsman 500	99-00	03-416
Sportsman 500	01-02	03-408
Sportsman 500	03-05	03-410
Sportsman 500	10-13	03-410
Outlaw 525	07-11	03-429
Sportsman 600	03-04	03-430
Sportsman 700	02-06	03-417

SUZUKI

MODEL	YEAR	PART #
LT-Z50 QuadSport	06-09	03-223
LT-Z50 QuadSport	17-19	03-223
LT80 QuadSport	87-06	03-210
LT-Z90 QuadSport	07-09	03-225
LT-Z90 QuadSport	14-19	03-225
LT160 QuadRunner	03-04	03-208
LT160E Quad Runner	89-92	03-208
LT-F160 QuadRunner	91-01	03-208
LT250R QuadRacer	85-86	03-203
LT250R QuadRacer	88-92	03-218
LT4WD 250	87-89	03-206
LT-4WD QuadRunner	90-96	03-207

MODEL	YEAR	PART #
LT-F250 QuadRunner	88-89	03-206
LT-F250 QuadRunner	90-96	03-207
LT-F250 QuadRunner	97-99	03-211
LT-F250 QuadRunner	00-01	03-214
LT-F250 Ozark	03-09	03-215
LT-F250 Ozark	12-14	03-215
LT-F250F QuadRunner	99	03-211
LT-F250F QuadRunner	00-02	03-214
LT-F4WD	97-98	03-207
LT-Z250 QuadSport	04-09	03-219
LT-F4WDX KingQuad	91-98	03-209
LT-F300F KindQuad	99	03-209

MODEL	YEAR	PART #
LT-F300F KingQuad	00-02	03-220
LT-A400 Eiger 2x4	02-07	03-213
LT-A400F Eiger 4x4	02-07	03-213
LT-A400F KingQuad	08-10	03-224
LT-F400F Eiger 4x4	02-07	03-213
LT-F400F KingQuad	08-10	03-224
LT-Z400/Z QuadSport	03-08	03-221
LT-A500F Vinson	02-07	03-216
LT-F500F QuadRunner	98-99	03-212
LT-F500F QuadRunner	00-02	03-212
LT-F500F Vinson	03-07	03-216

YAMAHA

MODEL	YEAR	PART #
YFM50 Raptor	04	03-323
YFM50R Raptor	05-08	03-323
YFM80 Badger	92-01	03-309
YFM80R Raptor	02-08	03-309
YFM90R Raptor	09-13	03-334
YFM90R Raptor	16-21	03-337
YFA-1 Breeze	89-04	03-319
YFM125 Grizzly	04-06	03-319
YFM125G Grizzly	07-13	03-329
YFM125R Raptor	11-13	03-335
YFS200 Blaster	88-06	03-301
YFB250 Timberwolf	92-98	03-306
YFB250FW Timberwolf	99-00	03-306
YFB250U Timberwolf	96-98	03-306
YFM250 Beartracker	99-02	03-316
YFM250B Big Bear	07-09	03-324

MODEL	YEAR	PART #
YFM250B Bruin	05-06	03-324
YFM250R Raptor	08-13	03-325
YFM250X Beartracker	03-04	03-316
YFM350 Bruin 2WD/4WD	04-06	03-321
YFM350 Grizzly 2WD/4WD	07-14	03-321
YFM350ER Moto-4	89-93	03-304
YFM350F Big Bear 4WD	97-99	03-330
YFM350FX Wolverine	96-05	03-326
YFM350R Raptor	04-08	03-322
YFM350R Raptor	09-13	03-322
YFM350U Big Bear 2WD	96-99	03-304
YFM350X Warrior	88-04	03-307
YFM350X Wolverine	06-09	03-331
YFZ350 Banshee	88-06	03-308
YFM400A Kodiak 2WD	00-04	03-313
YFM400F Big Bear	00-12	03-312

MODEL	YEAR	PART #
YFM400F Kodiak	96-98	03-311
YFM400FW Kodiak	93-95	03-304
YFM400M Big Bear	00-04	03-312
YFM450/EPS Grizzly	13-14	03-332
YFM450FA Kodiak	03-06	03-317
YFM450FG Grizzly	07-12	03-332
YFM450FX Wolverine	07-10	03-332
YFZ450	04-09	03-320
YFZ450	12-13	03-336
YXR450F Rhino	06-09	03-327
YFM600 Grizzly	98-00	03-314
YFM600F Grizzly	01	03-314
YFM660 Grizzly	02-05	03-318
YFM660F Grizzly	06-08	03-333
YFM660R Raptor	01-05	03-315*
YXR660F Rhino	04-07	03-328

* Parts included for two carburetors.

GAS GAS
HONDA
HUSQVARNA
KAWASAKI
KTM
SUZUKI
YAMAHA
DIRT BIKE SLEEVES
STREET BIKE SLEEVES
ACCESSORIES
TECHNICAL



UNIBAT BATTERIES

Unibat Batteries, since 1994 has been providing Europe with high quality and performance batteries to the Powersports market. Unibat is a leader in AGM battery technology with quality, performance and affordability. Since 2005, Unibat continues to be an OEM supplier to top brands including Ducati, Beta Motorcycles, Benelli, Husqvarna and Fantic. Unibat is a team sponsor to Gresini Racing Ducati in MotoGP. Through these relationships, Unibat continues to develop batteries that can perform at the highest level. Unibat continues to push development with our ultra-powerful and ultra-light Lithium-Ion batteries as well as Factory Activated AGM batteries. Switching to Unibat gives the confidence and comfort of knowing your battery will not let you down. Unibat Batteries, now available to you in the USA.



THE MF SERIES MAINTENANCE FREE AGM BATTERY is constructed with a lead calcium alloy and Absorbed Glass Mat technology. Free of maintenance, no spills or leaks. The highest AH capacity and the best endurance of charging performance are high marks of Unibat. Fiberglass mat separators and high cell concentration extend battery life and eliminate worries caused by vehicle vibration.



READY TO USE CX SERIES

This maintenance free High Performance AGM battery is 100% sealed and completely leak proof. 30% more powerful than traditional AGM batteries. Constructed with a lead calcium alloy and Absorbed Glass Mat technology. Free of maintenance, no spills or leaks. The highest AH capacity and the best endurance of charging performance are high marks of Unibat. Tightly packed construction and calcium reinforced grid plates prevent plate separation and high cell concentration extend battery life and eliminate worries caused by vehicle vibration. There's no need to add electrolyte water since the cells are already charged and ready to use.



LITHIUM EXTRA

The innovative range of Unibat lithium-ion batteries for motorcycles and powersports has been engineered for the most demanding users always looking for higher and safer performance, faster acceleration, extreme weight reduction (about 3X lighter than traditional) and much longer battery life. The strong starting currents generated by the battery power allow safe, repeated and consecutive starts, even at low temperatures. Ready to go, its' very long life is estimated to be over 5 years and over 2000 complete charge/discharge cycles ensures operation even after long periods of inactivity.



UNIBAT BATTERIES MOTORCYCLE

CC	MODEL	YEAR	MF SERIES	CX SERIES	LITHIUM EXTRA	CC	MODEL	YEAR	MF SERIES	CX SERIES	LITHIUM EXTRA
BMW						DUCATI (Continued)					
450	G450/X	2009-11	CTZ7S-BS		ULT1	803	SCRAMBLER DESERT SLED/NS	2015-22	CT12B-BS		ULT2
450	R45N	1978-84	12N20AH-BS		ULT3	803	MONSTER	2017-18	CT12B-BS		ULT2
500	R50/R/S	1956-64	12N20AH-BS		ULT3	821	MONSTER	2014-18	CT12B-BS		ULT2
600	C600 SPORT	2011-12	CTZ12S-BS		ULT2	848	848/STREETFIGHTER	2008-13	CT12B-BS		ULT2
600	C600 SPORT	2013-16	CBTX14-BS	CX14	ULT3	899	PANIGALE	2013-16	CT7B-BS		ULT1
650	C650 GT	2012-13	CTZ12S-BS		ULT2	900	CHROMO/DARK/M DARK	2001-02	CT12B-BS		ULT2
650	F650/S	1993-00	CIX30L-BS	CX30L	ULT5	900	SPORT	1999-	CT12B-BS		ULT2
650	F650 GS	2008-12	CBTX14-BS	CX14	ULT3	900	SS/SUPERSPORT	2001-07	CT12B-BS		ULT2
650	G650X CHALLENGE, MOTO, COUNTRY	2006-09	CTZ10S-BS		ULT2	904	SUPERSPORT 900	1999-			ULT3
700	F700 GS	2011-18	CBTX14-BS	CX14	ULT3	906	PASO	1990-92	CBTX20-BS		ULT4
700	F700 GS (auxiliary)	2011-18	CTZ14S-BS		ULT3	907	I.E. PASO	1990-94	CBTX20-BS		ULT4
800	F800ST/GS/GT	2007-18	CBTX14-BS	CX14	ULT3	916	BIPOSTO/SENNA/STRADA	1994-98			ULT3
800	R80/RT	1984-95	CIX30L-BS	CX30L	ULT5	916	I.E./SP/SPS	1994-98			ULT3
800	R80/7/RT	1978-84	CIX30L-BS	CX30L	ULT5	916	MONSTER S4	2001-07	CT12B-BS		ULT2
800	R80 ET	2000-	CIX30L-BS	CX30L	ULT5	916	SPORT TOURING 4	ALL	CT12B-BS		ULT2
850	F850 GS	2016-23	CBTX12-BS	CX12	ULT2	937	HYPERMOTARD 939/950	2016-22	CT12B-BS		ULT2
900	R90/G R90S	1969-84	CIX30L-BS	CX30L	ULT5	937	MULTISTRADA 950	2017-22	CT12B-BS		ULT2
900	R90 ST	2000-			ULT3	937	MONSTER 950	2019-22	CT12B-BS		ULT2
900	F900R /XR	2019-23	CBTX12-BS	CX12	ULT2	937	SUPERSPORT 950/S	2021-22	CT12B-BS		ULT2
1000	100 RS	1976-84	CIX30L-BS	CX30L	ULT5	944	ST2	1997-00			ULT3
1000	HP4	2012-14	CTZ7S-BS		ULT1	944	ST2	2001-02	CT12B-BS		ULT2
1000	HP4 (with alarm)	2012-14	CTZ10S-BS		ULT2	950	DESERT X	2022-24	CT12B-BS		ULT2
1000	HP4 RACE	2017-18			ULT2	955	PANIGALE V2	2016-23	CT7B-BS		ULT1
1000	K100/RS/RT	1983-93	CIX30L-BS	CX30L	ULT5	955	STREETFIGHTER/S V2	2016-22	CT7B-BS		ULT1
1000	MODELLI R	1977-94	CIX30L-BS	CX30L	ULT5	992	ST3	2004-07	CT12B-BS		ULT2
1000	R100 (ALL MODELS)	1976-95	CIX30L-BS	CX30L	ULT5	996	ST4/ST4S	2001-05	CT12B-BS		ULT2
1000	R100R	2000-	12N20AH-BS		ULT3	996	MONSTER/BIPOSTO	2001-06	CT12B-BS		ULT2
1000	R100RT/RS	1985-	CIX30L-BS	CX30L	ULT5	996	SPORT TOURING 4	2001-02	CT12B-BS		ULT2
1000	S1000RR DWA	2009-11	CTZ12S-BS		ULT2	996	MONOPOSTO	2001-02	CT12B-BS		ULT2
1000	S1000RR DWA	2014-16	CTZ10S-BS		ULT2	998	998/999	2002-07	CT12B-BS		ULT2
1000	S1000RR	2009-23	CTZ10S-BS		ULT2	998	MONOPOSTO/BIPOSTO	2001-03	CT12B-BS		ULT2
1000	S1000RR	2014-16	CTZ7S-BS		ULT1	998	SUPERLEGGERA V4	2020-22	CT12B-BS		ULT2
1000	S1000RR	2017-23	CBTX9-BS	CX9	ULT2	999	999 BIPOSTO/RS/SR	2003-05	CT12B-BS		ULT2
1000	S1000R	2014-23	CTZ10S-BS		ULT2	1000	DESMOSEDICI RR	2008-09	CT12B-BS		ULT2
1000	S1000XR	2015-23	CBTX9-BS	CX9	ULT2	1000	GT1000/EUROPE/TOURING	2007-09	CT12B-BS		ULT2
1000	S1000XR W/ALARM	2015-23	CBTX12-BS	CX12	ULT2	1000	MONSTER S/S2R/S4RS	2003-08	CT12B-BS		ULT2
1000	S1000XR DWA	2015-23	CTZ10S-BS		ULT2	1000	MULTISTRADA/SPORT	2003-06	CT12B-BS		ULT2
1100	K1100LT/RS	1990-95			ULT3	1000	SPORT/S BIPOSTO/GT ST3	2001-07	CT12B-BS		ULT2
1100	R1100R/GS/RT/RS	1994-01			ULT3	1000	ST2	ALL			ULT3
1100	R1100S ABS	1998-05			ULT3	1000	ST3	2004-07	CT12B-BS		ULT2
1150	R1150R/GS/RS/RT	2000-05			ULT3	1000	ST4/ST4S	ALL			ULT2
1170	R nineT	2013-22	CBTX14-BS	CX14	ULT3	1000	SUPERSPORT HF	2003-	CT12B-BS		ULT2
1200	HP2 SPORT/MEGAMOTO	2009-11	CBTX14-BS	CX14	ULT3	1078	HYPERMOTARD EVO SP	2010-	CT12B-BS		ULT2
1200	K1200 LT/GT/RS/S	1999-09			ULT3	1098	1098-	2007-09	CT12B-BS		ULT2
1200	K1200 R/S	2005-11	CBTX14-BS	CX14	ULT3	1098	SUPERBIKE/S/TRICOLORE	2007-	CT12B-BS		ULT2
1200	K1200R/S	1997-05			ULT3	1098	ALL OTHER MODELS	2001-10	CT12B-BS		ULT2
1200	R1200C	1998-05			ULT3	1100	HYPERMOTARD	2007-13	CT12B-BS		ULT2
1200	R1200 GS/S/R/ADV	2005-20	CBTX14-BS	CX14	ULT3	1100	MONSTER	2009-13	CT12B-BS		ULT2
1200	R1200RS	2014-18	CBTX14-BS	CX14	ULT3	1100	MULTISTRADA	2007-12	CT12B-BS		ULT2
1200	R1200RT	2005-13			ULT3	1100	STREETFIGHTER/S V4	2009-23	CT12B-BS		ULT2
1200	R1200RT	2014-18	CBTX16-BS		ULT3	1100	PANIGALE V4	2016-23	CT12B-BS		ULT2
1300	K1300R/S	2009-16	CBTX14-BS	CX14	ULT3	1100	SCRAMBLER PRO 1100	2018-23	CT12B-BS		ULT2
1300	K1300GT	2009-10			ULT3	1198	1198/MY08/SP/R	2009-11	CT12B-BS		ULT2
1300	K1300S HP	2012-16	CBTX14-BS	CX14	ULT3	1198	DIAVEL	2011-17	CT12B-BS		ULT2
1600	K1600 GT/GTL	2010-21			ULT3	1199	PANIGALE/S/1199	2011-14	CT7B-BS		ULT1
DUCATI						HARLEY DAVIDSON					
600	MONSTER/M DARK	2001-07	CT12B-BS		ULT2	883	XL/XLH IRON/ROADSTER	2014-22	CBTX14L-BS	CX14L	ULT3
600	PANTAH/TL	ALL			ULT3	883	XL/XLH	1997-03	CBTX20L-BS	CX20L	ULT4
650	MULTISTRADA	2007-	CT12B-BS		ULT2	883	XLH SPORTSTER	1986-95			ULT3
696	MONSTER	2009-13	CT12B-BS		ULT2	900	SPORTSTER	1952-66	CBTX14-BS	CX14	ULT3
700	MONSTER 695/696	2007-08	CT12B-BS		ULT2	1000	XL SERIES	1979-85			ULT3
748	SR/STRADA/BISPOSTO/SP	2001-02	CT12B-BS		ULT2	1000	XLCH SPORTSTER	1987-93			
749	749/SUPERBIKE	2003-06	CT12B-BS		ULT2	1000	XLCH SPORTSTER	1970-78			
750	DESMOIMOLA	ALL	CB12A-A-SM		ULT3	1000	XLCH SPORTSTER	1977-88	CBTX20-BS		ULT4
750	GT/LAGUNA SECA	ALL	CIX30L-BS	CX30L	ULT5	1000	XLCH SPORTSTER	1979-86	CBTX20-BS		ULT4
750	M DARK/M IE/M IE DARK	2001-02	CT12B-BS		ULT2	1000	XLCR CAFÉ RACER	1977-88	CBTX20-BS		ULT4
750	MONSTER/SS	2001-02	CT12B-BS		ULT2	1000	XLH/XL SERIES	1979-86	CBTX20-BS		ULT4
796	HYPERMOTARD	2010-12	CT12B-BS		ULT2	1000	XLX-61	1983-85	CBTX20-BS		ULT4
796	MONSTER	2010-13	CT12B-BS		ULT2	1000	XR1000	1983-85	CBTX20-BS		ULT4
800	MONSTER	2003-04	CT12B-BS		ULT2						
800	MONSTER	2010-16	CT12B-BS		ULT2						
800	MONSTER S2R	2004-15	CT12B-BS		ULT2						
800	SS/SUPERSPORT	2003-07	CT12B-BS		ULT2						



UNIBAT BATTERIES MOTORCYCLE

CC	MODEL	YEAR	MF SERIES	CX SERIES	LITHIUM EXTRA
HARLEY DAVIDSON (Continued)					
1100	XL/XLH SERIES	1987-93	CBTX20-BS		ULT4
1130	VRSC V-ROD	2002-07	CBTX14L-BS	CX14L	ULT3
1200	FORTY-EIGHT/NIGHTSTER	2011-22	CBTX14L-BS	CX14L	ULT3
1200	XL/XLH SPORTSTER	2004-22	CBTX14L-BS	CX14L	ULT3
1200	XL/XLH SPORTSTER	1997-03	CBTX20L-BS	CX20L	ULT4
1200	XL/XLH SPORTSTER	1987-96	CBTX20-BS		ULT4
1200	XR1200X	2011-12	CBTX14L-BS	CX14L	ULT3
1202	SEVENTY-TWO	2012-16	CBTX14L-BS	CX14L	ULT3
1250	VRSC V-ROD	2008-17	CBTX20L-BS	CX20L	ULT4
1340	FL/FLH TOURING	1997-98	CIX30L-BS	CX30L	ULT5
1340	FLST SERIES	1991-00	CBTX20L-BS	CX20L	ULT4
1340	FLST SERIES	1984-90	CBTX20-BS		ULT4
1340	FX/FXR SERIES	1979-93	CBTX20-BS		ULT4
1340	FXD SERIES	1997-00	CBTX20L-BS	CX20L	ULT4
1340	FXLR	1994-23	CBTX20-BS		ULT4
1340	FXR SERIES	1999-00	CBTX20-BS		ULT4
1340	FXST SERIES	1997-00	CBTX20L-BS	CX20L	ULT4
1340	FXST SERIES	1991-96			ULT4
1340	FXST SERIES	1980-90			ULT4
1450	FL/FLH TOURING	1999-06	CIX30L-BS	CX30L	ULT5
1450	FXD SERIES	1999-06	CBTX20L-BS	CX20L	ULT4
1450	FXST/FLST SERIES	2000-06	CBTX20L-BS	CX20L	ULT4
1570	FL/FLH TOURING	2007-11	CIX30L-BS	CX30L	ULT5
1570	FXD/FXST/FLST SERIES	2007-10	CBTX20L-BS	CX20L	ULT4
1584	FXD SERIES	2007-11	CBTX20L-BS	CX20L	ULT4
1584	FXST/FLST SERIES	2007-11	CBTX20L-BS	CX20L	ULT4
1584	FL/FLH TOURING	2007-10	CIX30L-BS	CX30L	ULT5
1690	FXD/FLS SERIES	2012-17	CBTX20L-BS	CX20L	ULT4
1690	FLHT TOURING	2010-16	CIX30L-BS	CX30L	ULT5
1750	FLH/FLT	2017-19	CIX30L-BS	CX30L	ULT5
1750	FX/FL	2018-19	CBTX20L-BS	CX20L	ULT4
1803	CVO FLH	2017-19	CIX30L-BS	CX30L	ULT5
1803	CVO FLST	2007-15	CBTX20L-BS	CX20L	ULT4
1803	CVO FXD	2007-15	CBTX20L-BS	CX20L	ULT4
1803	FLS	2016-17	CBTX20L-BS	CX20L	ULT4
1870	CVO FLH	2017-23	CIX30L-BS	CX30L	ULT5
1870	FX/FL	2018-23	CBTX20L-BS	CX20L	ULT4
HONDA					
50	LITTLE CUB	2000-13	CBTX4L-BS		ULT1
50	SA 50LX/N/S/SR	1988-01	CBTX4L-BS		ULT1
50	SA VISION/ SB50	1988-90	CBTX4L-BS		ULT1
50	SC 01	1997-01	CBTX4L-BS		ULT1
50	SE 50/ELITE	1987-89	CBTX4L-BS		ULT1
50	SG 50M/SGX 50SKY	1990-97	CBTX4L-BS		ULT1
50	SHADOW 50	1997-01	CBTX4L-BS		ULT1
50	SK50/M	1992-94	CBTX4L-BS		ULT1
50	TACT	2001-23	CTZ7S-BS/ CBTX5L-BS		ULT1
50	TC 50	2000-	CBTX7L-BS		ULT1
50	VISION 50	1993-12	CBTX4L-BS		ULT1
50	WALLAROO	ALL	CBTX4L-BS		ULT1
50	ZB 50P MONKEY	1988-	CBTX4L-BS		ULT1
50	ZOOMER	2005-23	CTZ7S-BS		ULT1
70	CT70 TRAIL	1991-94	CBTX4L-BS		ULT1
70	ST70	1989-94	CBTX4L-BS		ULT1
80	CH80 ELITE	1993-09	CBTX5L-BS		ULT1
80	NH80 AERO	1985-	CBTX5L-BS		ULT1
90	EZ90 CUB	1991-96	CBTX5L-BS		ULT1
90	SHADOW 90	1999-	CBTX4L-BS		ULT1
90	SUPER CUB 90	ALL	CBTX4L-BS		ULT1
100	LEAD	2008-	CBTX7L-BS		ULT1
110	CRF110	2013-18	CBTX4L-BS		ULT1
110	CRF110	2019-22	CBTX4L-BS		ULT1
125	CRF125F	2014-18	CBTX4L-BS		ULT1
125	CRF125F	2019-23	CTZ5S-BS		ULT1
125	MSX125 GROM	2013-23	CBTX4L-BS		ULT1
125	SHADOW 125	1999-09	CBTX7L-BS		ULT1
125	SPACY 125	2001-05	CTZ12S-BS		ULT2
125	VT125 SHADOW	ALL	CBTX7L-BS		ULT1
125	VT125C	1999-07	CTZ7S-BS		ULT1
125	XLR125R	1997-02	CBTX7A-BS		ULT1
125	Z125M/MA MONKEY	2019-23	CBTX4L-BS		ULT1
150	ADV150A	2021-23	CTZ8V-BS		ULT1

CC	MODEL	YEAR	MF SERIES	CX SERIES	LITHIUM EXTRA
HONDA (Continued)					
150	CH150 ELITE	1987-	CBTX9-BS	CX9	ULT2
150	CRF150F	2006-17	CTZ7S-BS		ULT1
200	TR200 FATCAT	1986-	CBTX9-BS	CX9	ULT2
200	TR200 FATCAT	1987-	CBTX7A-BS		ULT1
230	CRF230F	2003-19	CBTX5L-BS/ CTZ7S-BS		ULT1
230	CRF230L/M	2008-11	CTZ7S-BS/ CBTX5L-BS		ULT1
230	CRF230L	2014-	CBTX7L-BS		ULT1
250	CB250/NIGHTHAWK	1991-09	CBTX7L-BS		ULT1
250	CBR250R	2011-13	CBTX7L-BS		ULT1
250	CMX250 REBEL	1996-10	CBTX7L-BS		ULT1
250	CMX250 REBEL	1985-87	CBTX9A-BS		ULT2
250	CN250 HELIX	1986-09	CBTX12-BS	CX12	ULT2
250	CRF250X	2004-18	CBTX5L-BS/ CTZ7S-BS		ULT1
250	CRF250L	2012-16	CBTX7L-BS		ULT1
250	CRF250L/RL	2017-20	CTZ8V-BS		ULT1
250	CRF250R/RX	2018-23		(Current Option)	ULT1
250	NS250 REFLEX	2001-09	CTZ12S-BS		ULT2
250	NX250	1988-95	CBTX7L-BS		ULT1
250	XR250	1991-98	CBTX4L-BS		ULT1
300	CB300F/CBR300R	2015-23	CBTX7L-BS		ULT1
300	CB300R/CBF300	2019-23			ULT1
300	CMX300	2017-23			ULT1
300	CRF300R	2019-24			ULT1
400	CB400F CB1	1989-90	CBTX9-BS	CX9	ULT2
400	CBR400RR	1986-89	CBTX9-BS	CX9	ULT2
400	CBR400RR	1992-94	CBTX7L-BS		ULT1
450	CRF450R/RWE/RX	2018-23		(Current Option)	ULT1
450	CRF450L/RL	2019-22			ULT1
450	CRF450X	2005-17	CTZ7S-BS		ULT1
500	CBR500R	2013-18	CTZ10S-BS		ULT2
600	CB600 F	2004-06	CBTX7L-BS		ULT1
600	CB600 F HORNET	1998-01	CBTX7L-BS		ULT1
600	CB600 F HORNET	2002-03	CTZ7S-BS		ULT1
600	CB600 F HORNET	2004-13	CBTX7L-BS		ULT1
600	CB 600 SF	2002-	CTZ7S-BS		ULT1
600	CB600F	2007-08	CTZ10S-BS		ULT2
600	CB600F	2004-06	CBTX7L-BS		ULT1
600	CBR600F/F4	1987-00	CBTX9-BS	CX9	ULT2
600	CBR600 F4i/RR/RA	2001-23	CTZ10S-BS		ULT2
600	FSC/FJS SILVERWING	2002-15	CTZ12S-BS		ULT2
600	NTV600	1988-92	CBTX9-BS	CX9	ULT2
600	NV600C	1989-94	CBTX9-BS	CX9	ULT2
600	SHADOW 600	ALL	CBTX9-BS	CX9	ULT2
600	VT600C SHADOW VLX	1988-03	CBTX9-BS	CX9	ULT2
600	VT600C CD SHADOW	2004-07	CTZ10S-BS		ULT2
650	CB650F/FA/R/RA	2018-23	CTZ10S-BS		ULT2
650	CBR650F/R/RA	2014-23	CTZ10S-BS		ULT2
650	NT650 HAWK	1988-91	CBTX9-BS	CX9	ULT2
650	NTV650 REVERE	1988-97	CBTX9-BS	CX9	ULT2
650	NX650	1988-89	CBTX9-BS	CX9	ULT2
650	NX650 DOMINATOR	1988-97	CBTX9-BS	CX9	ULT2
650	SILVER WING 650	2002-05	CTZ12S-BS		ULT2
650	SLR650	1996-01	CBTX9-BS	CX9	ULT2
650	XL650V	2000-07	CTZ12S-BS		ULT2
650	XR650L	1993-23	CBTX9-BS	CX9	ULT2
700	VT700C SHADOW	1998-00	CBTX14-BS	CX14	ULT3
700	VT700C/CA	2004-	CTZ12S-BS		ULT2
700	XL700V TRANSALP	2008-12	CTZ14S-BS		ULT2
750	NC750X/XC	2018-23	CTZ14S-BS		ULT2
750	NR750	1992-	CBTX12-BS	CX12	ULT2
750	NV750 SHADOW	1997-98	CBTX14-BS	CX14	ULT3
750	RVF750R	1994-95	CBTX9-BS	CX9	ULT2
750	VF750C MAGNA	1993-94	CBTX9-BS	CX9	ULT2
750	VF750C/C2/D	1994-03	CBTX12-BS	CX12	ULT2
750	VF750C/C2/D	2007-10	CTZ12S-BS		ULT2
750	VFR750F	1987-97	CBTX12-BS	CX12	ULT2
750	VFR750R	1988-90	CBTX9-BS	CX9	ULT2
750	VFR750R (RC45)	1994-	CBTX9-BS	CX9	ULT2
750	VT750C/C2/C2B/RS	1998-00	CBTX14-BS	CX14	ULT3
750	VT750C/C2/C2B/RS	2004-10	CTZ12S-BS		ULT2
750	VT750CD SHADOW ACE	1998-03	CBTX14-BS	CX14	ULT3
750	VT750CD SHADOW SPRINT	2001-07	CTZ14S-BS		ULT2



UNIBAT BATTERIES MOTORCYCLE

CC	MODEL	YEAR	MF SERIES	CX SERIES	LITHIUM EXTRA
HONDA (Continued)					
750	VT750C RS/S PHANTOM	2010-22	CTZ14S-BS		ULT2
750	XRV750 AFRICAN TWIN	1993-98	CBTX14-BS	CX14	ULT3
800	PC800 PACIFIC COAST	1989-98	CBTX12-BS	CX12	ULT2
800	VF800A INTERCEPTOR	2002-10	CTZ12S-BS		ULT2
800	VF800 FI	1998-01	CBTX12-BS	CX12	ULT2
800	VFR800 INTERCEPTOR ABS	2002-16	CTZ12S-BS		ULT2
900	CB900F HORNET	2002-07	CTZ10S-BS		ULT2
900	CBR900RR	1992-99	CBTX9-BS	CX9	ULT2
900	CBR900RR	2000-02	CTZ10S-BS		ULT2
919	CB900F (919)	2002-06	CTZ10S-BS		ULT2
929	CBR929RR	2000-01	CTZ10S-BS		ULT2
954	CBR954RR	2002-03	CTZ10S-BS		ULT2
1000	CB1000	1994-95	CBTX12-BS	CX12	ULT2
1000	CB1000F/FT	1993-96	CBTX12-BS	CX12	ULT2
1000	CB1000R	2009-18	CTZ10S-BS		ULT2
1000	CBF1000/F	2006-18	CTZ10S-BS		ULT2
1000	CBR1000 XX	2001-04	CTZ12S-BS		ULT2
1000	CBR1000RA	2008-19	CTZ10S-BS		ULT2
1000	CBR1000RR	2004-07	CTZ10S-BS		ULT2
1000	CBR1000RR	2008-19	CTZ7S-BS		ULT1
1000	CRF1000L AFRICA TWIN	2016-17	CTZ14S-BS		ULT2
1000	CRF1000L AFRICA TWIN	2018-19			ULT1
1000	RC213V-S	2016-17	CTZ7S-BS		ULT1
1000	RVT1000 RC51	2000-05	CTZ12S-BS		ULT2
1000	VTR1000	1997-00	CBTX12-BS	CX12	ULT2
1000	VTR1000 SUPER HAWK	2001-05	CTZ12S-BS		ULT2
1000	XL1000V VARADERO	1999-02	CBTX14-BS	CX14	ULT3
1000	XL1000V VARADERO	2003-10			ULT4
1100	CB1100	2010-14	CTZ14S-BS		ULT2
1100	CBR1100XX	1997-00	CBTX12-BS	CX12	ULT2
1100	CBR1100XX	2001-04	CTZ12S-BS		ULT2
1100	VT1100 SHADOW	2000-07	CBTX14-BS	CX14	ULT3
1100	VT1100 SHADOW ACE	1995-99	CTZ14S-BS		ULT2
1200	VFR1200F	2010-14	CTZ14S-BS		ULT2
1200	VFR1200X	2016-17	CTZ14S-BS		ULT2
1300	CB1300S C-ABS	2007-13	CTZ14S-BS		ULT2
1300	CB1300 SUPER FOUR	1998-21	CTZ14S-BS		ULT2
1300	CB1300DC X4	1997-03	CBTX14-BS	CX14	ULT3
1300	CTX1300	2014-	CTZ14S-BS		ULT2
1300	ST1300 A/P/ABS	2003-13	CTZ14S-BS		ULT2
1300	STX1300	2001-	CTZ14S-BS		ULT2
1300	VT1300CS/CR/CXA/FURY	2009-20	CTZ14S-BS		ULT2
1300	VTX1300C/R/S/RETRO	2003-12	CBTX14-BS	CX14	ULT3
1500	GL1500 VALKYRIE	1997-03	CBTX14-BS	CX14	ULT3
1800	GL1800 GOLDWING	2001-23	CBTX20L-BS	CX20L	ULT4
1800	NRX1800 VALKYRIE RUNE	2004-05	CBTX20L-BS	CX20L	ULT4
1800	VTX1800C/F/N/R/S/RETRO	2002-11	CBTX20L-BS	CX20L	ULT4
HUSBERG					
250	250 FE	ALL	CBTX4L-BS		ULT1
350	350 FE	ALL	CBTX4L-BS		ULT1
400	TE410	ALL	CBTX14-BS	CX14	ULT3
450	FE450/FS450 E/6	ALL	CTZ7S-BS		ULT1
550	FE550E/6	ALL	CTZ7S-BS		ULT1
600	LT/SM/TE 610	ALL	CBTX14-BS	CX14	ULT3
650	FE/FS650 E/6	ALL	CTZ7S-BS		ULT1
	ALL ELEC START MOTORS	1997-03	CBTX9-BS	CX9	ULT2
	ALL ELEC START MOTORS	2004-13	CTZ7S-BS		ULT1
HUSQVARNA					
150	TE150/TE150i	2017-23			ULT1
250	FC250	2016-23			ULT1
250	FE250	2014-19			ULT1
250	TE250	2014-16			ULT1
250	TE250i	2019-23			ULT1
250	TC250	2023-			ULT1
250	TE250	2010-13	CTZ7S-BS		ULT1
250	TXC250/250i	2010-13	CTZ7S-BS		ULT1
300	TE/TX300	2019-23			ULT1
310	TE310	2009-13	CTZ7S-BS		ULT1
350	FC/FE/FX350	2016-23			ULT1
400	TE410	2000-01	CBTX14-BS	CX14	ULT3
401	VITPILEN 401	2018-23			ULT2
450	TC/TE449	2011-13	CTZ7S-BS		ULT1
450	FC/FE/FS/FX 450	2016-23			ULT1

CC	MODEL	YEAR	MF SERIES	CX SERIES	LITHIUM EXTRA
HUSQVARNA (Continued)					
501	FE501/S	2014-23			ULT1
510	SMR 511	2011-	CBTX14-BS	CX14	ULT3
510	SM/SMR/TE510	2004-10	CTZ7S-BS		ULT1
610	SM/SMR/TE610	2006-08	CBTX14-BS	CX14	ULT3
610	SM/TE 610	2000-01	CBTX14-BS	CX14	ULT3
630	SMS/TE 630	2011-	CBTX14-BS	CX14	ULT3
650	TR STRADA	2013-	CBTX14-BS	CX14	ULT3
701	ENDURO/SUPERMOTO	2016-22	CTZ10S-BS		ULT2
900	NUDA 900 R	2011-	CBTX14-BS	CX14	ULT2
901	NORDEN 901	2022-23			ULT2
KAWASAKI					
110	KLX110/L	2003-23	CBTX4L-BS		ULT1
125	KLX125	2003-06	CBTX7L-BS		ULT1
125	Z125 PRO	2017-23	CBTX4L-BS		ULT1
140	KLX140G/L	2008-23	CBTX7L-BS		ULT1
230	KLX230R	2020-23	CBTX5L-BS		ULT1
230	KLX230 ABS/S/SE	2020-23	CBTX7A-BS		ULT1
250	EX250 NINJA	1995-07	CBTX7L-BS		ULT1
250	EX250 NINJA	2008-	CBTX7A-BS		ULT1
250	EX250 NINJA	2009-12	CBTX9-BS	CX9	ULT2
250	GPZ250R	1995-	CBTX7L-BS		ULT1
250	KL250/D/KLR	1985-05			ULT1
250	KL250 SUPER SERPA	2000-10	CBTX7L-BS		ULT1
250	KLX250ES G1/G2	1994-95	CBTX7L-BS		ULT1
250	KLX250S	2006-20	CBTX7L-BS		ULT1
250	KX250F/X	2021-23		(Current Option)	ULT1
300	EX300 NINJA	2013-17	CBTX9-BS	CX9	ULT2
300	VERSYS X300	2017-23	CBTX9-BS	CX9	ULT2
400	EX400 NINJA	2018-23	CBTX9-BS	CX9	ULT2
400	FX/GPX400R	ALL	CB12A-A-SM		ULT3
400	KLX400R/SR	2003-04	CT7B-BS		ULT1
400	Z400/ER400	2019-22	CBTX9-BS	CX9	ULT2
400	ZR400C ZEPHYR	1989-08	CBTX12-BS	CX12	ULT2
400	ZR400D XANTHUS	1992-95	CBTX9-BS	CX9	ULT2
400	ZXR400R	1989-99	CBTX9-BS	CX9	ULT3
400	ZZ-R400	1990-07	CBTX12-BS	CX12	ULT2
450	KLX450R	2008-10	CTZ7S-BS		ULT1
450	KX450	2019-23		(Current Option)	ULT1
500	H1 SERIES	1969-72	CBTX9A-BS		ULT1
600	ZX600E/F/ZX-6 NINJA	1993-02	CBTX12-BS	CX12	ULT2
600	ZX600FA NINJA	2008-19	CBTX9-BS	CX9	ULT2
600	ZX600G/J ZX-6R	1998-08	CBTX9-BS	CX9	ULT2
600	ZX600K ZX6-RR	2003-06	CBTX9-BS	CX9	ULT2
600	ZZR600	2002-04	CBTX12-BS	CX12	ULT2
600	ZZR600	2005-09	CBTX9-BS	CX9	ULT2
636	ZX636B/C NINJA ZX-6R	2003-23	CBTX9-BS	CX9	ULT2
650	EJ650 A/C	1999-04	CBTX14-BS	CX14	ULT3
650	ER 6N/6F	2006-12	CBTX12-BS	CX12	ULT2
650	KL650 VERSYS	2008-20	CBTX12-BS	CX12	ULT2
650	KLR650 A/C/B/E/	1987-18	CBTX14AHL-BS	CX14AHL	ULT3
650	KLR650 A/C/B/E/	2022-24	CBTX9-BS	CX9	ULT2
650	KLX650 C/R	1993-97	CBTX9-BS	CX9	ULT2
650	NINJA 650R	2006-11	CBTX12-BS	CX12	ULT2
650	NINJA 650R	2012-16	CT12A-BS		ULT2
650	NINJA 650	2017-23	CTZ10S-BS		ULT2
650	Z 650	2017-19	CTZ10S-BS		ULT2
750	KZ750L NINJA	1993-	CBTX9-BS	CX9	ULT2
750	ZR750 ZEPHYR	1991-94	CBTX12-BS	CX12	ULT2
750	ZR750	2005-06	CBTX9-BS	CX9	ULT2
750	ZR-7S	2000-05	CBTX12-BS	CX12	ULT2
750	ZX750J NINJA ZX-7	1991-95	CBTX12-BS	CX12	ULT2
750	ZX750K NINJA ZX-7R	1991-97	CBTX9-BS	CX9	ULT2
750	ZX750L ZX-7	1993-94	CBTX9-BS	CX9	ULT2
750	ZX750M NINJA	1993-95	CBTX9-BS	CX9	ULT2
750	ZX750P NINJA ZX-7R	1996-03	CBTX12-BS	CX12	ULT2
800	VN800A/B/C/D/E VULCAN	1995-03	CBTX14-BS	CX14	ULT3
800	VN800A/B/E/ VULCAN	2004-06	CBTX12-BS	CX12	ULT2
800	W800	2011-22	CBTX12-BS	CX12	ULT2
800	Z800	2013-16	CBTX9-BS	CX9	ULT2
900	VN900 VULCAN CLASSIC	2006-23	CBTX12-BS	CX12	ULT2
900	Z900/Z900RS	2017-23	CBTX9-BS	CX9	ULT2
900	ZX900B ZX-9R	1994-97	CBTX12-BS	CX12	ULT2
900	ZX900C/E/F NINJA	1998-03	CBTX9-BS	CX9	ULT2

GASGAS HONDA HUSQVARNA KAWASAKI KTM SUZUKI YAMAHA DIRT BIKE SLEEVES STREET BIKE SLEEVES ACCESSORIES TECHNICAL



UNIBAT BATTERIES MOTORCYCLE

CC	MODEL	YEAR	MF SERIES	CX SERIES	LITHIUM EXTRA
KAWASAKI (Continued)					
1000	KLV1000	2004-05	CBTX14-BS	CX14	ULT3
1000	KLZ1000	2012-19	CBTX9-BS	CX9	ULT2
1000	NINJA 1000 ABS	2011-13	CBTX9-BS	CX9	ULT2
1000	NINJA 1000 ABS	2014-16	CT12A-BS		ULT2
1000	NINJA 1000 ABS	2017-23	CBTX9-BS	CX9	ULT2
1000	NINJA H2/H2R	2015-23	CTZ10S-BS		ULT2
1000	VERSYS 1000	2015-23	CBTX9-BS	CX9	ULT2
1000	Z1000	2003-13	CBTX9-BS	CX9	ULT2
1000	Z100 ABS	2014-16	CT12A-BS		ULT2
1000	ZG1000A CONCOURS	1986-06	CBTX20L-BS	CX20L	ULT4
1000	ZX1000C NINJA ZX-10R	2004-10	CT12B-BS		ULT2
1000	ZX-10R ABS ZX1000	2011-23	CTZ10S-BS		ULT2
1000	ZX10RR	2017-21	CTZ10S-BS		ULT2
1100	GPZ1100E/F	1995-97	CBTX14-BS	CX14	ULT3
1100	ZRX1100	1997-00	CBTX14-BS	CX14	ULT3
1100	ZX1100D NINJA	1993-01	CBTX14-BS	CX14	ULT3
1100	ZX1100E	1995-97	CBTX14-BS	CX14	ULT3
1100	ZXR1100	1997-00	CBTX14-BS	CX14	ULT3
1100	ZZR1000EU	1993-	CBTX14-BS	CX14	ULT3
1200	ZRX1200R	2001-05	CBTX14-BS	CX14	ULT3
1200	ZRX1200 DAEG	2009-13	CBTX12-BS	CX12	ULT2
1200	ZX-12R/ZZR 1200	2000-05	CBTX14-BS	CX14	ULT3
1400	ZG1400 CONCOURS ABS	2008-23			ULT2
1400	ZX-14 NINJA	2006-23	CBTX14-BS	CX14	ULT3
1500	VN1500E/N/VULCAN	1996-09			ULT3
1500	VN1500P NOMAD/DRIFTER	1999-05			ULT3
1600	VN1600A/D/VULCAN	2003-09			ULT3
1600	VN1600B VULCAN MEAN STREAK	2004-09			ULT3
1600	VN1700 CLASSIC VOYAGER	2009-20			ULT3
1700	VN1700 VULCAN VAQUERO	2021-23			ULT3
2000	VN2000A VULCAN CLASSIC	2004-10			ULT3
KTM					
125	XC 125	2021-23		(Current Option)	ULT1
150	XCW TPI	2020-23		(Current Option)	ULT1
200	XC/XC-W	2014-	CBTX5L-BS		ULT1
200	XCW	2015-16	CBTX4L-BS		ULT1
250	250 EXC SIX DAYS	2012-17	CBTX4L-BS		ULT1
250	EXC250	2005-10	CBTX5L-BS/ CTZ7S-BS		ULT1
250	EXC250 RACING	2003-05	CTZ5S-BS		ULT1
250	EXC-F 250	2017-19	CBTX5L-BS/ CBTX4L-BS		ULT1
250	FREERIDE	2015-18	CBTX5L-BS/ CBTX4L-BS		ULT1
250	SX-F FACTORY EDITION	2015.5-16			ULT1
250	SX-F	2012-15	CBTX4L-BS		ULT1
250	SX-F	2016-17	CBTX4L-BS		ULT1
250	SX-F	2018-23		(Current Option)	ULT1
250	XC 250	2009-13	CBTX4L-BS		ULT1
250	XC 250	2014-	CBTX5L-BS		ULT1
250	XC 250	2015-17	CBTX4L-BS		ULT1
250	XC 250	2018-19	CBTX4L-BS		ULT1
250	XC 250 TPI	2022-23		(Current Option)	ULT1
250	XC-F 250	2016-23		(Current Option)	ULT1
250	XCF-W 250	2008-11	CBTX5L-BS		ULT1
250	XCF-W 250	2012-16	CBTX4L-BS		ULT1
250	XC-W 250	2009-13	CBTX4L-BS		ULT1
250	XC-W 250	2014-	CBTX5L-BS		ULT1
250	XC-W 250	2015-17	CBTX4L-BS		ULT1
250	XC-W 250	2018-23		(Current Option)	ULT1
250	XC-W 250 TPI	2019-23		(Current Option)	ULT1
300	EXC 300 TPI	2020-23		(Current Option)	ULT1
300	XC 300	2009-13	CBTX4L-BS		ULT1
300	XC 300	2014-	CBTX5L-BS		ULT1
300	XC 300	2015-16	CBTX4L-BS		ULT1
300	XC 300	2017-19		(Current Option)	ULT1
300	XC 300 TPI	2020-23		(Current Option)	ULT1
300	XC-W 300	2009-13	CBTX4L-BS		ULT1
300	XC-W 300	2014-	CBTX5L-BS		ULT1
300	XC-W 300	2015-17	CBTX4L-BS		ULT1
300	XC-W 300	2018-		(Current Option)	ULT1
300	XC-W 300 TPI	2019-22		(Current Option)	ULT1
350	EXC-F 350	2012-16	CBTX4L-BS		ULT1
350	EXC-F 350	2017-23		(Current Option)	ULT1
350	SX-F 350	2011-15	CBTX4L-BS		ULT1

CC	MODEL	YEAR	MF SERIES	CX SERIES	LITHIUM EXTRA
KTM (Continued)					
350	SX-F 350	2016-17		(Current Option)	ULT1
350	SX-F 350	2018-23		(Current Option)	ULT1
350	XC-F 350	2011-15	CBTX5L-BS		ULT1
350	XC-F 350	2016-23		(Current Option)	ULT1
350	XCF-W 350	2012-16	CBTX4L-BS		ULT1
350	XCF-W 350	2020-23		(Current Option)	ULT1
350	LC4/EXC/RXC	1996-01	CBTX9-BS	CX9	ULT2
390	DUKE/RC390	2013-18	CBTX9-BS	CX9	ULT2
400	EXC	2000-02	CTZ7S-BS		ULT1
400	EXC RACING	2003-	CTZ5S-BS		ULT1
400	LC4/LC4-E/LS-E/RXC	1997-01	CBTX9-BS	CX9	ULT2
400	XC-W	2009-10	CTZ7S-BS		ULT1
450	EXC/SXF/XCF/W	2007-10	CTZ7S-BS		ULT1
450	EXC-F 450	2019-22		(Current Option)	ULT1
450	SX-F 450	2011-15	CBTX4L-BS		ULT1
450	SX-F 450	2016-17		(Current Option)	ULT1
450	SX-F 450	2018-22		(Current Option)	ULT1
450	XC-F/XC-W 450	2009-15	CBTX5L-BS		ULT1
450	XC-F 450	2016-17		(Current Option)	ULT1
450	XC-F 450	2018-22		(Current Option)	ULT1
500	500 K4 LC	ALL	CBTX9A-BS		ULT2
500	EXC	2012-16	CTZ7S-BS		ULT1
500	EXC-F	2017-22		(Current Option)	ULT1
500	XCF-W 500	2020-22		(Current Option)	ULT1
520	EXC/MXC	2000-02	CBTX4L-BS		ULT1
525	EXC/MXC	2000-03	CTZ7S-BS		ULT1
530	EXC/XC-W	2005-12	CTZ7S-BS		ULT1
620	DUKE/LC4/ADVENTURE	1996-98	CBTX9-BS	CX9	ULT2
625	SMC/SXC	2003-09	CTZ10S-BS		ULT2
640	DUKE/RXC/LC4/ADVEN.	1999-02	CBTX9-BS	CX9	ULT2
640	DUKE I/II/LC4/ADVEN	2003-08	CTZ10S-BS		ULT2
690	DUKE 690	2009-12	CTZ10S-BS		ULT2
690	DUKE	2013-17	CBTX9-BS	CX9	ULT2
690	ENDURO R	2008-21	CTZ10S-BS		ULT2
690	SMC-R/SUPERMOTO	2009-21	CTZ10S-BS		ULT2
790	ADVENTURE/DUKE	2019-20	CT12A-BS		ULT2
890	DUKE/ADVENTURE	2021-22	CTZ10S-BS		ULT2
950	ADVENTURER	2003-	CTZ12S-BS		ULT2
950	SUPERENDURO	2009-11	CTZ12S-BS		ULT2
990	ADVENTURE	2003-09	CTZ12S-BS		ULT2
990	SUPER DUKE/SUPERMOTO	2009-13	CTZ12S-BS		ULT2
1090	ADVENTURE	2017-19	CTZ12S-BS		ULT2
1090	RC8	2009-10	CTZ12S-BS		ULT2
1190	ADVENTURE	2013-	CTZ12S-BS		ULT2
1190	RC8	2009-16	CTZ12S-BS		ULT2
1290	SUPER ADVENTURE	2014-20	CTZ12S-BS		ULT2
1290	SUPER DUKE/R	2017-21	CTZ12S-BS		ULT2
SUZUKI					
125	UH BURGMAN	2002-08	CBTX9-BS	CX9	ULT2
150	AN BURGMAN	2003-06	CBTX9-BS	CX9	ULT2
150	AN150 BURGMAN	THRU 1998	CBTX7A-BS		ULT1
150	AN150 BURGMAN	2002-06	CBTX7A-BS		ULT1
200	DR200SE	1996-13	CBTX7L-BS		ULT1
200	DR200S	2015-20	CBTX7L-BS		ULT1
200	UH BURGMAN K7	2007-19	CBTX9-BS	CX9	ULT2
250	AN250 BURGMAN	2000-02	CBTX9-BS	CX9	ULT2
250	AN250 BURGMAN	2003-17	CBTX12-BS	CX12	ULT2
250	DRZ250	2001-07	CTZ7S-BS		ULT1
250	GSX250R	2018-20	CBTX9-BS	CX9	ULT2
250	GW250	2013-17	CBTX9-BS	CX9	ULT2
250	TU250X	2009-19	CBTX7L-BS		ULT1
350	DR350S/ES	1990-99	CBTX4L-BS		ULT1
350	DR350SE	1994-99	CBTX7L-BS		ULT1
400	AN400 BURGMAN	1999-20	CBTX9-BS	CX9	ULT2
400	DRZ400S/E/SM	2000-23	CT7B-BS		ULT1
400	GS400E/X	1991-95	CBTX9-BS	CX9	ULT2
400	GSF BANDIT	1991-93	CBTX9-BS	CX9	ULT2
400	GSR400/GSX400	ALL	CBTX9-BS	CX9	ULT2
400	GSX-400R/RF	1991-95	CBTX9-BS	CX9	ULT2
400	SV400S	2002-	CBTX9-BS	CX9	ULT2
450	RMX450	2010-22	CTZ7S-BS		ULT1
600	GSF600 S/BANDIT	1996-03	CBTX9-BS	CX9	ULT2
600	GSR600	THRU 2003	CBTX9-BS	CX9	ULT2



UNIBAT BATTERIES MOTORCYCLE

CC	MODEL	YEAR	MF SERIES	CX SERIES	LITHIUM EXTRA
SUZUKI (Continued)					
600	GSX F 600	1986-08	CBTX9-BS	CX9	ULT2
600	GSXF 600 KATANA	1998-08	CBTX9-BS	CX9	ULT2
600	GSX-R600	1992-93	CBTX9-BS	CX9	ULT2
600	GSX-R600	1997-23	CBTX9-BS	CX9	ULT2
600	RF600R/S	1993-96	CBTX9-BS	CX9	ULT2
600	VS600 GLS	ALL	CBTX9-BS	CX9	ULT2
650	AN650 BURGMAN	2003-17	CBTX14-BS	CX14	ULT3
650	DL650 V STORM	2004-22	CBTX12-BS	CX12	ULT2
650	DR650S	1990-91			ULT1
650	DR650S/N/P	1992-93	CBTX4L-BS		ULT1
650	DR650S/E/ES/ER	1994-95	CBTX12-BS	CX12	ULT2
650	DR650SE	1996-97			ULT2
650	DR650SE	1998-20	CBTX9-BS	CX9	ULT2
650	GSF BANDIT	2005-08	CBTX9-BS	CX9	ULT2
650	GSX650F	2008-11	CBTX9-BS	CX9	ULT2
650	LS650 SAVAGE	1986-14			ULT3
650	SFV650 GLAUDIUS	2009-14			ULT2
650	SV650	1999-02			ULT2
650	SV650A/S/SA	2003-10			ULT2
650	SV650S/SA	2003-13	CBTX12-BS	CX12	ULT2
750	GSX750F KATANA	1998-05	CBTX9-BS	CX9	ULT2
750	GSXR-750	1996-99	CBTX9-BS	CX9	ULT2
750	GSXR-750	2000-19			ULT2
750	GSXR-750W	1992-93	CBTX12-BS	CX12	ULT2
750	GSXR-750W	1994-96	CBTX9-BS	CX9	ULT2
750	GSXS-750	2015-19			ULT2
800	VL800 INTRUDER C50/M50	2001-21	CBTX12-BS	CX12	ULT2
800	VL800 BOULEVARD	2001-21	CBTX12-BS	CX12	ULT2
800	VZ800 M800	2005-08	CBTX12-BS	CX12	ULT2
800	VZ800 MARAUDER	1997-08	CBTX12-BS	CX12	ULT2
900	RF900 RR/S/ZS	1994-97	CBTX9-BS	CX9	ULT2
1000	DL1000 V STORM	2002-16	CBTX14-BS	CX14	ULT3
1000	DL1000 V STORM	2018-19			ULT3
1000	GSX-R1000	2001-04	CBTX12-BS	CX12	ULT2
1000	GSX-R1000	2005-16			ULT2
1000	GSX-R1000	2017-18	CTZ10S-BS		ULT2
1000	GSX-R1000A/Z	2020-23	CTZ10S-BS		ULT2
1000	GSX-S1000	2016-23			ULT2
1000	SV1000S	2003-07	CBTX14-BS	CX14	ULT3
1000	TL1000R	1998-03			ULT2
1000	TL1000S	1997-01	CBTX12-BS	CX12	ULT2
1100	GSX-R1100	1993-98	CBTX12-BS	CX12	ULT2
1100	TL1100S/V	1997-01	CBTX12-BS	CX12	ULT2
1200	GSF1200 BANDIT	1997-05	CBTX12-BS	CX12	ULT2
1200	GSX1200	1999-	CBTX12-BS	CX12	ULT2
1250	GSF1250F BANDIT	2007-16			ULT2
1300	GSX1300 B-KING	2008-11	CBTX12-BS	CX12	ULT2
1300	GSX1300R HAYABUSA	1999-07			ULT2
1300	GSX1300R HAYABUSA	2008-22	CBTX12-BS	CX12	ULT2
1400	GSX1400	2002-	CBTX14-BS	CX14	ULT3
1400	VS1400GL/GLP/S83	1987-11			ULT4
1500	VL1500 BOULEVARD C90	1998-11			ULT4
1500	VL1500 INTRUDER	1998-11			ULT4
1500	VL/VZ1500 BOULEVARD M90	2009-17			ULT3
1600	M95 BOULEVARD/MARAUDER	2004-05			ULT4
1800	M1800R INTRUDER	2006-21			ULT3
1800	VLR1800 C109R	2008-12			ULT3
1800	VZR1800 M109R BOULEVARD	2006-21			ULT3
TRIUMPH					
600	DAYTONA	2003-05	CBTX9-BS	CX9	ULT2
600	TT600	2000-03	CBTX12-BS	CX12	ULT2
650	BONNEVILLE	ALL			ULT1
675	DAYTONA 675	2006-11	CT7B-BS		ULT1
675	DAYTONA 675	2012-16	CBTX9-BS	CX9	ULT2
675	STREET TRIPLE R	2008-17	CBTX9-BS	CX9	ULT2
750	BONNEVILLE/TIGER	ALL	CBTX9A-BS		ULT1
750	DAYTONA 750	1990-97			ULT3
750	SPEED TRIPLE	1993-97			ULT3
750	T150 TRIDENT	ALL			ULT1
800	BONNEVILLE	2001-05	CBTX12-BS	CX12	ULT2
800	SPEEDMASTER	2003-05	CBTX12-BS	CX12	ULT2
800	TIGER/TIGER XC	2011-17			ULT4
865	AMERICA	2001-13			ULT2

CC	MODEL	YEAR	MF SERIES	CX SERIES	LITHIUM EXTRA
TRIUMPH (Continued)					
865	BONNEVILLE T100/SE	2008-10			ULT2
865	BONNEVILLE T100/SE	2011-16	CBTX12-BS	CX12	ULT2
865	BONNEVILLE T100/SE	2005-07	CBTX12-BS	CX12	ULT2
865	SCRAMBLER	2005-07	CBTX12-BS	CX12	ULT2
865	SCRAMBLER	2008-10			ULT2
865	SCRAMBLER	2011-16	CBTX12-BS	CX12	ULT2
865	SPEEDMASTER	2003-15	CBTX12-BS	CX12	ULT2
865	THRUXTON	2003-16	CBTX12-BS	CX12	ULT2
885	THUNDERBIRD SPORT	ALL	CBTX14-BS	CX14	ULT3
885	TIGER/TIGER XC	1999-01	CBTX14-BS	CX14	ULT3
900	SCRAMBLER/BONNEVILLE	2006-07	CBTX12-BS	CX12	ULT2
900	THRUXTON	2003-08	CBTX12-BS	CX12	ULT2
900	TIGER	1999-01	CBTX14-BS	CX14	ULT3
955	DAYTONA 955i	1999-04	CBTX14-BS	CX14	ULT3
955	SPEED TRIPLE/SPRINT	1999-04	CBTX14-BS	CX14	ULT3
955	SPRINT RS	2000-04	CBTX14-BS	CX14	ULT3
955	TIGER	2002-06	CBTX14-BS	CX14	ULT3
1050	SPEED TRIPLE/R	2005-10	CBTX12-BS	CX12	ULT2
1050	SPEED TRIPLE/R	2011-18	CBTX14-BS	CX14	ULT3
1050	SPRINT ST	2005-10	CBTX12-BS	CX12	ULT2
1050	SPRINT GT	2011-18	CBTX14-BS	CX14	ULT3
1050	TIGER/SE	2007-12	CT12B-BS		ULT2
1050	TIGER/SE	2013-18	CBTX14-BS	CX14	ULT3
1200	BONNEVILLE	2017-	CBTX9-BS	CX9	ULT2
1200	DAYTONA/TROPHY	2000-04	CBTX14-BS	CX14	ULT3
1215	TIGER EXPLORER	2012-18	CBTX20L-BS	CX20L	ULT4
1215	TROPHY	2012-17	CBTX20L-BS	CX20L	ULT4
1600	THUNDERBIRD	2009-18	CBTX20L-BS	CX20L	ULT4
1700	THUNDERBIRD STORM	2011-	CBTX20L-BS	CX20L	ULT4
2300	ROCKET III	2003-19	CBTX20L-BS	CX20L	ULT4
YAMAHA					
50	TTR50E	2006-23	CT4B-BS		ULT1
50	VOX 50	2010-	CBTX5L-BS		ULT1
90	TTR90E	2003-07	CT4B-BS		ULT1
100	AEROX	ALL	CBTX4L-BS		ULT1
110	TTR110E	2008-23	CT4B-BS		ULT1
125	TTR125E/LE	2003-24	CBTX4L-BS		ULT1
125	ZUMA 125	2009-23	CBTX7A-BS		ULT1
225	TTR225	1999-05	CT7B-BS		ULT1
225	XT225	2001-07	CTZ7S-BS		ULT1
225	XT225 SEROW	1992-00	CBTX7L-BS		ULT1
230	TTR230E	2005-20	CTZ7S-BS		ULT1
230	TTR230E	2021-24	CBTX5L-BS		ULT1
250	TTR250	1999-06	CT7B-BS		ULT1
250	WR250F	2003-09	CBTX5L-BS		ULT1
250	WR250R/X/F	2008-20	CTZ7S-BS		ULT1
250	XT250	2008-23	CTZ7S-BS		ULT1
250	XT250V	2006-	CBTX7L-BS		ULT1
250	XTZ250	2007-	CBTX7L-BS		ULT1
250	YZ250F	2019-23		(Current Option)	ULT1
250	YZ250FX	2015-19	CTZ7S-BS		ULT1
250	YZ250FX	2020-23		(Current Option)	ULT1
300	VP300	2004-	CBTX9-BS	CX9	ULT2
300	XC VERSITY	2003-06	CBTX9-BS	CX9	ULT2
450	WR450F	2003-23	CTZ7S-BS		ULT1
450	WR450F	2024			ULT1
450	YZ450F/FX	2018-24		(Current Option)	ULT1
450	YZ450FX	2016-18	CTZ7S-BS		ULT1
500	XT500E	1993-	CBTX9-BS	CX9	ULT2
600	XT600E/F/G/EH/EN	1990-02	CBTX9-BS	CX9	ULT2
600	YZF600R	1995-03	CBTX12-BS	CX12	ULT2
600	YZF-R6 600	1999-00	CT12B-BS		ULT2
600	YZF-R6 600	2001-05	CT9B-BS		ULT2
600	YZF-R6 600	2006-16	CTZ10S-BS		ULT2
600	YZF-R6 600	2017-23	CTZ7S-BS		ULT1
600	YZF-R6S 600	2006-07	CT9B-BS		ULT2
660	XT660Z	2004-10	CT9B-BS		ULT2
660	XTZ660 TENERE	1992-96	CBTX9-BS	CX9	ULT2
700	FZ-07	2015-17	CTZ10S-BS		ULT2
700	MT-07	2018-24	CTZ10S-BS		ULT2
700	XSR700	2018-22	CTZ10S-BS		ULT2
700	TENERE 700 XTZ7MB	2021-24	CTZ10S-BS		ULT2
750	YZF750R/RF/SP/RJ/RH/RK	1993-99	CBTX12-BS	CX12	ULT2
750	YZF-R7	1999-	CT9B-BS		ULT2

GASGAS
HONDA
HUSQVARNA
KAWASAKI
KTM
SUZUKI
YAMAHA
DIRT BIKE SLEEVES
STREET BIKE SLEEVES
ACCESSORIES
TECHNICAL



UNIBAT BATTERIES MOTORCYCLE

CC	MODEL	YEAR	MF SERIES	CX SERIES	LITHIUM EXTRA
YAMAHA (Continued)					
800	FZ8 FAZER	2010-13	CTZ10S-BS		ULT2
847	NIKEN/NIKEN GT	2019-22	CTZ10S-BS		ULT2
847	TRACER/TRACER GT	2019-22	CTZ10S-BS		ULT2
850	TDM850	1992-93	CBTX12-BS	CX12	ULT2
850	TRX850	1995-99	CBTX12-BS	CX12	ULT2
900	FJ-09/FZ-09	2014-17	CTZ10S-BS		ULT2
900	MT-09	2018-23	CTZ10S-BS		ULT2
900	TDM900	2010-	CBTX12-BS	CX12	ULT2
900	XJ900P	ALL	CBTX14-BS	CX14	ULT3
900	XJ900S DIVERSION	1995-02	CBTX14-BS	CX14	ULT3
900	XSR900	2016-23	CTZ10S-BS		ULT2
950	BOLT /BOLT R-SPEC	2014-24	CTZ14S-BS		ULT3
950	SCR950	2017-	CTZ14S-BS		ULT3
950	XVS950/V-STAR 950	2009-17	CTZ14S-BS		ULT3
1000	FZ-10 FAZER	2017-	CTZ10S-BS		ULT2
1000	FZR1000	1991-95	CBTX14-BS	CX14	ULT3
1000	FZS1000 FZ-1	2006-15	CTZ14S-BS		ULT3
1000	FZS1000 FZ-1	2001-05	CT14B-BS		ULT3
1000	GTS1000 A	1993-94	CBTX14-BS	CX14	ULT3
1000	S1000	1993-94	CBTX14-BS	CX14	ULT3
1000	MT-10	2019-24	CTZ10S-BS		ULT2

CC	MODEL	YEAR	MF SERIES	CX SERIES	LITHIUM EXTRA
YAMAHA (Continued)					
1000	YZF1000R	1997-98	CBTX14-BS	CX14	ULT3
1000	YZF-R1	1999-03	CT14B-BS		ULT3
1000	YZF-R1	2004-14	CTZ10S-BS		ULT2
1000	YZF-R1	2015-24	CTZ7S-BS		ULT1
1200	FJ1200	1991-93	CBTX14-BS	CX14	ULT3
1200	XJR1200/SP	1995-	CBTX14-BS	CX14	ULT3
1200	XT1200 SUPER TENERE	2010-24	CTZ12S-BS		ULT2
1300	FJR1300	2003-18	CT14B-BS		ULT3
1300	XJR1300	2007-10	CTZ14S-BS		ULT3
1300	XVS1300 V-STAR/MIDNIGHT	2009-18	CBTX20L-BS	CX20L	ULT4
1300	XVZ1300 ROYAL STAR	1996-12	CBTX20L-BS	CX20L	ULT4
1300	V-STAR TOURER	2016-17	CBTX20L-BS	CX20L	ULT4
1600	XV1600 ROAD STAR/WILD STAR	1999-06	CBTX20L-BS	CX20L	ULT4
1700	MT-01 S	2002-08	CT14B-BS		ULT3
1700	V-MAX	2009-22	CTZ14S-BS		ULT3
1700	XV1700 ROAD STAR	2002-08	CT14B-BS		ULT3
1700	XV1700AT/MV/AV/AVC	2004-07	CBTX20L-BS	CX20L	ULT4
1700	XV1700AT/MV/AV/AVC	2008-14	CT14B-BS		ULT3
1854	RAIDER/S	2008-17	CT14B-BS		ULT3
1854	ROADLINER/STRATOLINER	2006-14	CT14B-BS		ULT3
1854	STAR ELUDER/VENTURE	2018-23	CBTX20L-BS	CX20L	ULT4



UNIBAT BATTERIES ATV & UTV

CC	MODEL	YEAR	MF SERIES	CX SERIES	LITHIUM EXTRA
AEON (Benzai)					
50/90/100	Cobra CX SPORT 50/90/100	All Years	CBTX4L-BS		ULT1
ARCTIC CAT					
50	DVX50	2006-10	CBTX5L-BS/ CTZ7S-BS		ULT1
90	ALL MODELS 90	2002-05	CBTX5L-BS/C74- 7T7S-BS		ULT1
90	DVX90	2006-19	CBTX5L-BS/ CTZ7S-BS		ULT1
150	150 UTILITY/ALTERRA	2010-19	CBTX9-BS	CX9	ULT2
250	250 UTILITY	2006-10	CBTX12-BS	CX12	ULT2
250	DVX250	2006-10	CBTX12-BS	CX12	ULT2
300	300 UTILITY	2010-16	CBTX12-BS	CX12	ULT2
300	DVX300	2009-15	CBTX12-BS	CX12	ULT2
300	ALTERRA 300	2017-20	CBTX12-BS	CX12	ULT2
366	366 4x4	All Years	CBTX14AH-BS	CX14AH	ULT3
400	DVX400	All Years	CBTX9-BS	CX9	ULT2
450	XC450/TRV/CORE	2011-17	CBTX14AH-BS	CX14AH	ULT3
500	500 ALL ATV MODELS	All Years	CBTX20-BS	CX20L	ULT4
500	500 ALTERRA	2016-18	CBTX20(L)-BS	CX20L	ULT4
500	500HDX PROWLER	2017-22	CIX30L-BS	CX30L	ULT5
500	500 PROWLER	2017-22	CBTX20L-BS	CX20L	ULT4
550	ALTERRA/TRV550	2009-17	CBTX20-BS	CX20	ULT4
550	550 PROWLER	2009-15	CBTX24HL-BS	CX24HL	ULT4
570	570 ALTERRA	2019-20	CBTX20-BS	CX20L	ULT4
650	650 H1/TBX	2005-12	CBTX14AH-BS	CX14AH	ULT3
650	650 PROWLER	2006-09	CBTX24HL-BS	CX24HL	ULT4
700	700 ALTERRA	2017-21	CBTX20-BS	CX20L	ULT4
700	700 EFI/FIS	2006-10	CBTX14AH-BS	CX14AH	ULT3
700	700 CORE/TRV/XT	2009-21	CBTX20-BS	CX20L	ULT4
700	700 PROWLER	2010-17	CIX30L-BS	CX30L	ULT5
700	700 WILDCAT SPORT/TRAIL	2015-19	CIX30L-BS	CX30L	ULT5
1000	1000 PROWLER	2009-17	CIX30L-BS	CX30L	ULT5
1000	1000 WILDCAT	2012-19	CIX30L-BS	CX30L	ULT5
1000	1000 H2/THUNDERCAT	2008-17	CBTX20-BS	CX20L	ULT4
BOMBARDIER/CAN-AM					
50	DS50	2002-06	CBTX4L-BS		ULT1
70	DS70	2009-22	CBTX4L-BS		ULT1
90	DS90	2009-22	CBTX4L-BS		ULT1
250	DS250	2006-22	CBTX12-BS	CX12	ULT2
330	OUTLANDER 330	2004-05	CBTX15L-BS		ULT3
400	OUTLANDER 400	2003-05	CBTX15L-BS		ULT3
400	OUTLANDER 400 EFI	2004-15	CBTX20L-BS	CX20L	ULT4
450	DS450	2008-15	CT7B-BS		ULT1
450	OUTLANDER 450	2015-17	CBTX20L-BS	CX20L	ULT4
500	OUTLANDER 500	2007-17	CBTX20L-BS	CX20L	ULT4

CC	MODEL	YEAR	MF SERIES	CX SERIES	LITHIUM EXTRA
570	OUTLANDER 570	2016-19	CBTX20L-BS	CX20L	ULT4
650	DS650	2000-07	CBTX15L-BS		ULT3
650	OUTLANDER 650	2006-17	CBTX20L-BS	CX20L	ULT4
800	COMMANDER 800	2011-20	CBTX20L-BS	CX20L	ULT4
800	DEFENDER 800	2016-21	CBTX20L-BS	CX20L	ULT4
800	DEFENDER 800XT	2016-21	CIX30L-BS	CX30L	ULT5
800	OUTLANDER 800	2006-15	CBTX20L-BS	CX20L	ULT4
800	TRAXTER PRO/XT 800	2017-20	CIX30L-BS	CX30L	ULT5
850	OUTLANDER 850	2016-19	CBTX20L-BS	CX20L	ULT4
850	RENEGADE 850	2016-19	CBTX20L-BS	CX20L	ULT4
1000	COMMANDER 1000	2011-21	CBTX20L-BS	CX20L	ULT4
1000	DEFENDER 1000	2016-22	CBTX20L-BS	CX20L	ULT4
1000	DEFENDER 1000 MAX	2017-22	CIX30L-BS	CX30L	ULT5
1000	MAVERICK 1000	2013-22	CBTX20L-BS	CX20L	ULT4
1000	OUTLANDER 1000	2013-22	CBTX20L-BS	CX20L	ULT4
1000	RENEGADE 6x6 1000	2013-22	CBTX20L-BS	CX20L	ULT4
1000	TRAXTER 1000	2016-22	CBTX20L-BS	CX20L	ULT4
CANNONDALE					
400/440	All Models	2001-03	CBTX9-BS	CX9	ULT2
CF MOTO					
400	CFORCE 400	2016-19	CIX30L-BS	CX30L	ULT5
500	CFORCE 500	2007-14	CBTX20L-BS	CX20L	ULT4
500	CFORCE 500	2016-19	CIX30L-BS	CX30L	ULT5
600	CFORCE 600	2019-	CIX30L-BS	CX30L	ULT5
800	CFORCE 800	2012-19	CIX30L-BS	CX30L	ULT5
1000	CFORCE 1000	2021-	CIX30L-BS	CX30L	ULT5
DERBI					
200	DXR 200 QUAD	2004-05	CBTX9-BS	CX9	ULT1
250	DXR 250 QUAD	2004-05	CBTX9-BS	CX9	ULT1
E-TON					
50	50 AXL/TXL/NXL	1999-03	CBTX4L-BS		ULT1
50	50 ALL MODELS	2004-08	CBTX5L-BS		ULT1
70	VIPER 70	Thru 2013	CBTX5L-BS		ULT1
90	90 AXL/TXL/NXL	1999-03	CBTX4L-BS		ULT1
90	90 ALL MODELS	2004-13	CBTX5L-BS		ULT1
90	90 DXL SIERRA	2000-03	CBTX5L-BS		ULT1
150	CXL 150 YUKON	2000-13	CBTX9-BS	CX9	ULT2
150	YXL 150 YUKON	2000-03	CBTX9-BS	CX9	ULT2
150	VIPER 150	Thru 2013	CBTX9-BS	CX9	ULT2
250	VECTOR 250	Thru 2013	CBTX12-BS	CX12	ULT2
HONDA					
90	TRX90	2006-22	CBTX5L-BS		ULT1
125	ATC125	1984-85	CBTX9A-BS	CX9	ULT2
125	ATC125	1986-87	CBTX12-BS	CX12	ULT2
125	TRX125	1985-86	CBTX9A-BS	CX9	ULT2
125	TRX125	1987-88	CBTX9-BS	CX9	ULT2



UNIBAT BATTERIES ATV & UTV

CC	MODEL	YEAR	MF SERIES	CX SERIES	LITHIUM EXTRA
HONDA (Continued)					
200	ATC200 BIG RED	1982-84	CBTX14AH-BS	CX14AH	ULT3
200	ATC200M	1984-85	CBTX14AH-BS	CX14AH	ULT3
200	TRX200 FOURTRAX	1984-	CBTX14AH-BS	CX14AH	ULT3
200	TRX200SX	1986-88	CBTX12-BS	CX12	ULT2
200	TRX200	1990-96	CBTX12-BS	CX12	ULT2
250	ATC250ES	1985-87	CBTX12-BS	CX12	ULT2
250	ATC250SX	1985-87	CBTX12-BS	CX12	ULT2
250	TRX250 FOURTRAX	1985-87	CBTX12-BS	CX12	ULT2
250	TRX250	1997-08	CBTX12-BS	CX12	ULT2
250	TRX250EX	2001-19	CBTX9-BS	CX9	ULT2
250	TRX250 RECON	1997-22	CBTX12-BS	CX12	ULT2
300	TRX300 FOURTRAX	1988-00	CBTX14-BS	CX14	ULT3
300	TRX300EX	1993-12	CBTX9-BS	CX9	ULT2
300	TRX300 FW	1988-00	CBTX14-BS	CX14	ULT3
350	FL350 ODYSSEY	1985-	CBTX12-BS	CX12	ULT2
350	TRX350 FOREMAN	1987-89	CBTX14-BS	CX14	ULT3
350	TRX350 FOURTRAX	1986-89	CBTX14-BS	CX14	ULT3
350	TRX350 RANCHER	2000-06	CBTX14-BS	CX14	ULT3
400	FL400 PILOT	1989-90	CBTX14-BS	CX14	ULT3
400	TRX400 RANCHER FA	2004-07	CBTX14-BS	CX14	ULT3
400	TRX400EX SPORTRAX	1999-14	CBTX9-BS	CX9	ULT2
400	TRX400FW FOREMAN	1995-03	CBTX14-BS	CX14	ULT3
420	TRX420 FE/FM/TE/TM	2007-17	CBTX14-BS	CX14	ULT3
420	TRX420 FA	2014-22	CBTX14-BS	CX14	ULT3
450	TRX450ER	2006-14	CTZ7S-BS		ULT1
450	TRX450ES/S	1998-04	CBTX14-BS	CX14	ULT3
500	PIONEER 500	2015-18	CBTX14-BS	CX14	ULT3
500	TRX500 RUBICON	2001-11	CBTX14-BS	CX14	ULT3
500	TRX500ES FOREMAN	2005-08	CBTX14-BS	CX14	ULT3
500	TRX500FE/FM/TM	2005-14	CBTX14-BS	CX14	ULT3
520	TRX520	2020-21	CBTX14-BS	CX14	ULT3
650	TRX650 RINCON	2003-05	CBTX14-BS	CX14	ULT3
680	TRX680 RINCON	2006-22	CBTX20L-BS	CX20L	ULT4
700	MUV700	2009-13	CBTX14-BS	CX14	ULT3
700	PIONEER 700	2014-20	CBTX14-BS	CX14	ULT3
700	TRX700XX	2008-13	CBTX9-BS	CX9	ULT2
1000	PIONEER 1000	2016-22	CBTX14-BS	CX14	ULT3
1000	TALON 1000 R/X	2019-22	CBTX20HL-BS	CX20L	ULT4
HYOSUNG					
50	TE50	2005-	CBTX5L-BS		ULT1
90	TE90	2005-	CBTX5L-BS		ULT1
450	TE450	2007-	CBTX9-BS	CX9	ULT2
450	TE450S	2010-13	CBTX9-BS	CX9	ULT2
KASEA					
50	MINI SKYHAWK 50	All Years	CBTX4L-BS		ULT1
50	SKYHAWK 50	All Years	CBTX5L-BS		ULT1
65	KS/KU 65	All Years	CBTX7A-BS		ULT1
90	KS/KU 90	All Years	CBTX7A-BS		ULT1
90	SKYHAWK 90	All Years	CBTX5L-BS		ULT1
125	KS/KU 125	All Years	CBTX7A-BS		ULT1
150	SKYHAWK 150	All Years	CBTX7A-BS		ULT1
170	SKYHAWK 170	All Years	CBTX7A-BS		ULT1
250	SKYHAWK 250	All Years	CBTX7A-BS		ULT1
KAWASAKI					
50	KFX50	2007-22	CBTX5L-BS		ULT1
80	KFX80	2003-06	CBTX5L-BS		ULT1
90	KFX90	2007-22	CBTX5L-BS		ULT1
110	KLF110 MOJAVE	1987-88	CBTX9A-BS		ULT2
185	KLF185 BAYOU	1985-88	CB10L-B2-SM		
200	KLT200A	1981-84	CB10L-B2-SM		
200	KLT200B	1983-	CB12A-A-SM		
200	KLT200C	1981-84	CB10L-B2-SM		
220	KLF220 BAYOU	1988-02	CB10A-A2-SM		
250	KLF250 BAYOU	2003-12	CBTX14AH-BS	CX14AH	ULT3
300	KEF300 LAKOTA SPORT	0995-03	CBTX14AH-BS	CX14AH	ULT3
300	KLF300 BAYOU	1988-00	CBTX14AH-BS	CX14AH	ULT3
300	KVF300 PRAIRIE	1999-02	CBTX14AH-BS	CX14AH	ULT3
300	KVF300 BRUTE FORCE	2013-22	CBTX12-BS	CX12	ULT2
360	KVF360 PRAIRIE	2003-13	CBTX14AH-BS	CX14AH	ULT3
400	KLF400 BAYOU	1993-00	CB16CL-B-SM		
400	KSF/KFX400	2003-06	CBTX9-BS	CX9	ULT2
400	KVF400 PRAIRIE	1997-02	CBTX14AH-BS	CX14AH	ULT3
450	KFX450R	2008-14	CBTX7L-BS		ULT1

CC	MODEL	YEAR	MF SERIES	CX SERIES	LITHIUM EXTRA
KAWASAKI (Continued)					
500	MULE 500,520,550	All Years	CBTX14AH-BS	CX14AH	ULT3
600	KAF400 MULE 600/610	2005-16	CBTX14AH-BS	CX14AH	ULT3
450	KAF450 MULE 1000	All Years	CB16CL-B-SM		
540	KAF540 MULE 2010	All Years	CB16CL-B-SM		
620	KAF620	All Years	CB16CL-B-SM		
620	MULE 2500/2510/2520	All Years	CB16CL-B-SM		
620	MULE 3000/3010/3020	All Years	CBTX20L-BS	CX20L	ULT4
620	KAF620 ADVANTAGE	2003-07	CBTX20L-BS	CX20L	ULT4
620	KAF620 CANADIAN	2009-16	CBTX20HL-BS	CX20HL	ULT4
650	BRUTE FORCE 650	2005-13	CBTX14-BS	CX14	ULT3
650	PRAIRIE 650	2002-03	CBTX14-BS	CX14	ULT3
700	KFX/KVF700	2004-09	CBTX14-BS	CX14	ULT3
750	KVF750 BRUTE FORCE	2005-22	CBTX14-BS	CX14	ULT3
750	TERYX 750	All Years	CALL		CALL
800	TERYX4 800	All Years	CALL		CALL
820	820 MULE		OEM		CALL
950	KAF950 MULE		OEM		CALL
1000	TERYX KRX1000	All Years	OEM		CALL
KTM					
450	450 SX/XC	2008-10	CBTX5L-BS		ULT1
505	505 SX/XC	2008-09	CBTX5L-BS		ULT1
525	525 SX	All	CBTX5L-BS		ULT1
KYMCO					
50/90	MONGOOSE 50/90	All Years	CBTX5L-BS		ULT1
150	MXU150	All Years	CBTX9-BS	CX9	ULT2
250/300	MONGOOSE 250/300	All Years	CBTX12-BS	CX12	ULT2
250/300	MXU250/300	All Years	CBTX12-BS	CX12	ULT2
450	MAXXER 450	All Years	CBTX20L-BS	CX20L	ULT4
450/500	UXV450/500/700	All Years	CBTX20L-BS	CX20L	ULT4
500	MXU500	All Years	CBTX20L-BS	CX20L	ULT4
700	MXU700	All Years	CBTX20L-BS	CX20L	ULT4
POLARIS					
50	PREDATOR 50	2004-07	CBTX5L-BS		ULT1
50	OUTLAW 50	2008-19	CBTX5L-BS		ULT1
50	SCRAMBLER 50	2001-03	CBTX5L-BS		ULT1
70	OUTLAW 70	2022-	CBTX9-BS	CX9	ULT2
90	PREDATOR 90	2003-06	CBTX5L-BS		ULT1
90	OUTLAW 90	2007-16	CBTX5L-BS		ULT1
90	SPORTSMAN 90	2001-16	CBTX5L-BS		ULT1
90	SCRAMBLER 90	2001-03	CBTX5L-BS		ULT1
110	OUTLAW 110	2016-22	CBTX5L-BS		ULT1
110	SPORTSMAN 110	2016-22	CBTX5L-BS		ULT1
150	RANGER/AGE 150 EFI	2017-22	CBTX9-BS	CX9	ULT2
170	RZR 170	2009-21	CBTX12-BS	CX12	ULT2
200	PHOENIX 200	2005-22	CBTX12-BS	CX12	ULT2
200	SAWTOOTH 200	2006-	CBTX12-BS	CX12	ULT2
250	250 ALL MODELS	1985-06	CBTX14AH-BS	CX14AH	ULT3
300	300 HAWKEYE	2006-10	CB14-BS-SM		
325	325 ALL MODELS	1987-02	CBTX14AH-BS	CX14AH	ULT3
330	330 MAGNUM	2003-13	CBTX14AH-BS	CX14AH	ULT3
330	330 TRAILBOSS	2003-13	CBTX14AH-BS	CX14AH	ULT3
330	330 ACE	2014-15	CBTX14AH-BS	CX14AH	ULT3
335	335 SPORTSMAN	1998-01	CBTX14AH-BS	CX14AH	ULT3
350	350 ALL MODELS	1990-96	CBTX14AH-BS	CX14AH	ULT3
400	400 ALL MODELS	1994-14	CBTX14AH-BS	CX14AH	ULT3
425	425 ALL MODELS	1995-02	CBTX14AH-BS	CX14AH	ULT3
450	450 DIESEL (PRIMARY)	1999-03	CIX30L-BS	CX30L	ULT5
450	450 DIESEL (SECONDARY)		CBTX14AH-BS	CX14AH	ULT3
450	OUTLAW 450	2008-10	CBTX9-BS	CX9	ULT2
450	SPORTSMAN HO 450	2016-20	CBTX14AH-BS	CX14AH	ULT3
500	500 ALL MODELS	1999-12	CBTX14AH-BS	CX14AH	ULT3
500	OUTLAW 500	2006-07	CBTX9-BS	CX9	ULT2
500	PREDATOR 500	2003-07	CBTX9-BS	CX9	ULT2
500	RANGER 500 4X4	2004-10	CIX30L-BS	CX30L	ULT5
500	RANGER 500 6X6	1998-00	CIX30L-BS	CX30L	ULT5
500	SPORTSMAN 500 EFI	2006-10	CBTX20HL-BS	CX20L	ULT4
525	OUTLAW 525	2008-11	CBTX9-BS	CX9	ULT2
550	SPORTSMAN 550	2010-14	CBTX14AH-BS	CX14AH	ULT3
570	RZR 570	2012-17	CBTX14AH-BS	CX14AH	ULT3
570	RZR 570 EPS	2012-17	CIX30L-BS	CX30L	ULT5
570	RANGER 570	2014-22	CBTX14AH-BS	CX14AH	ULT3
570	SPORTSMAN 570	2015-22	CBTX14AH-BS	CX14AH	ULT3
600	SPORTSMAN 600	2003-05	CIX30L-BS	CX30L	ULT5



UNIBAT BATTERIES ATV & UTV

CC	MODEL	YEAR	MF SERIES	CX SERIES	LITHIUM EXTRA
POLARIS (Continued)					
700	RANGER 700 4X4	2006-10	CIX30L-BS	CX30L	ULT5
700	RANGER 700 6X6	2006-10	CIX30L-BS	CX30L	ULT5
700	SPORTSMAN 700	2002-06	CIX30L-BS	CX30L	ULT5
800	RANGER 800	2010-14	CIX30L-BS	CX30L	ULT5
800	RZR 800 EFI "S"	2008-14	CBTX20HL-BS	CX20L	ULT4
800	RZR 4/S 800	2010-14	CIX30L-BS	CX30L	ULT5
800	SPORTSMAN 800 EFI/HO	2005-14	CIX30L-BS	CX30L	ULT5
800	SPORTSMAN FOREST	2005-14	CBTX20HL-BS	CX20L	ULT4
850	SCRAMBLER 850	2013-18	CBTX20HL-BS	CX20L	ULT4
850	SCRAMBLER 850 48"	2019-22	CIX30L-BS	CX30L	ULT5
850	SPORTSMAN 850 WV	2009-22	CIX30L-BS	CX30L	ULT5
850	SPORTSMAN 850 XP/EPS	2010-21	CBTX20HL-BS	CX20L	ULT4
900	ACE 900 EFI EPS	2016-19	CIX30L-BS	CX30L	ULT5
900	RZR900	2011-14	CIX30L-BS	CX30L	ULT5
900	RANGER XP 900	2016-	CIX30L-BS	CX30L	ULT5
1000	SCRAMBLER 1000	2014-18	CBTX20HL-BS	CX20L	ULT4
1000	SPORTSMAN 1000	2015-21	CBTX20HL-BS	CX20L	ULT4
1000	SPORTSMAN 1000 48"	2019-22	CIX30L-BS	CX30L	ULT5
1000	RZR XP/4 1000	2015-21	CIX30L-BS	CX30L	ULT5
1000	RZR XP PRO 1000	2020-22	CIX30L-BS	CX30L	ULT5
1000	RZR TURBO R 1000	2020-22	CIX30L-BS	CX30L	ULT5
1000	RANGER XP 1000	2017-22	CIX30L-BS	CX30L	ULT5
1000	SLINGSHOT	2016-22	CIX30L-BS	CX30L	ULT5
QIANJIANG					
50/100	ATV 50/100	All Years	CBTX4L-BS		ULT1
SYM					
180	TRACK RUNNER 180	All Years	CBTX12-BS		ULT2
250	QUAD LENDER 250	2006-07	CBTX12-BS		ULT2
300	QUAD LENDER 300	2007-08	CBTX12-BS		ULT2
SUZUKI					
50	LTZ50 QUADSPORT	2006-10	CBTX5L-BS		ULT1
80	LT80 QUADSPORT	All Years	CBTX5L-BS		ULT1
90	LTZ-90	2007-21	CBTX7A-BS		ULT1
160	LT160E	1989-04	CB9A-A-SM		
160	LTF160	1991-01	CB9A-A-SM		
230	LT230E QUADRUNNER	1988-93	CBTX12-BS	CX12	ULT2
230	LT230GE	1985-87	CB10A-A2-SM		
250	LT250EF	1985-86	C50-N18A-A-SM		
250	LTF250 QUADRUNNER	1988-02	CBTX14AH-BS	CX14AH	ULT3
250	LTF250 OZARK	2002-16	CBTX12BS	CX12	ULT2
250	LT250 QUADSPORT	2004-11	CBTX12-BS	CX12	ULT2
280	LTF280 KINGQUAD	1991-99	CBTX14AH-BS	CX14AH	ULT3
300	LT300E QUADRUNNER	1987-89	CBTX14AH-BS	CX14AH	ULT3
300	LTF300 KING QUAD	1999-02	CBTX14AH-BS	CX14AH	ULT3
400	LT-A 400 EIGER 2X4	2002-07	CBTX14-BS	CX14	ULT3
400	LT-F 400 EIGER 4X4	2002-07	CBTX14-BS	CX14	ULT3
400	LTZ400 QUADSPORT	2003-16	CBTX9-BS	CX9	ULT2
400	LT-A 400 KINGQUAD	2002-21	CBTX14-BS	CX14	ULT3
450	LT-A 450 KINGQUAD	2007-10	CBTX14-BS	CX14	ULT3
450	LT-R 450 QUADRACER	2006-09	CBTX7A-BS		ULT1
500	LT-A 500F	2000-01	CBTX16-BS	CX16B	ULT3
500	LT-A 500 KING QUAD	2002-21	CBTX20CH-BS	CX20L	ULT4
500	LT-A/F 500F	1998-03	CBTX16-BS	CX16B	ULT3
500	LT-F 500F VINSON	2004-07	CBTX20CH-BS	CX20L	ULT4
620	QUV 620F	2005-	CBTX20L-BS	CX20L	ULT4
700	LT-A 700 KING QUAD	2005-07	CBTX20CH-BS	CX20L	ULT4
700	LT-V 700F TWIN	2004-05	CBTX14-BS	CX14	ULT3
750	LT-A 750 KING QUAD	2008-21	CBTX20CH-BS	CX20L	ULT4
YAMAHA					
50	RAPTOR 50	2004-09	12N7D-3B-SM		
50	YFZ50	2017-22	CBTX5L-BS		ULT1
80	BADGER YFM80	1985-01	12N7D-3B-SM		
80	GRIZZLY YFM80	2005-08	12N7D-3B-SM		
80	RAPTOR YFM80	2002-08	12N7D-3B-SM		
90	RAPTOR YFM90	2009-22	CBTX5L-BS		ULT1
100	CHAMP YFM100	1987-91	12N7D-3B-SM		
125	BREEZE YFA 125	1989-04	CB12C-A-SM		
125	YFM125S	2004-12	CB12C-A-SM		
125	RAPTOR YFM125R	2011-13	CTZ7S-BS		ULT1

CC	MODEL	YEAR	MF SERIES	CX SERIES	LITHIUM EXTRA
YAMAHA (Continued)					
200	YFM200 MOTO-4	1985-89	CB14A-A1-SM		
200	TRI-MOTO YTM200	1983-85	CB14A-A1-SM		
225	TRI-MOTO YTM225	1983-86	CB14A-A1-SM		
225	YFM225 MOTO-4	1986-88	CB14A-A1-SM		
250	YFB250 TIMBERWOLF	1992-00	CB12C-A-SM		
250	YFM250 BEARTRACKER	1999-04	CB14A-A1-SM		
250	YFM250 BIG BEAR	2007-08	CB14A-A1-SM		
250	YFM250 BRUIN	2005-06	CB14A-A1-SM		
250	YFM250 MOTO-4	1989-91	CB14A-A1-SM		
250	YFM250R RAPTOR	2008-13	CTZ7S-BS		ULT1
300	GRIZZLY 300	2011-13	CBTX12-BS	CX12	ULT2
350	YFM350 BRUIN	2004-06	CBTX14AH-BS	CX14AH	ULT3
350	GRIZZLY YFM350	2007-14	CBTX14AH-BS	CX14AH	ULT3
350	RAPTOR YFM350	2004-13	CTZ10S-BS		ULT2
350	YFP350 TERRA PRO	1988-	CB14A-A1-SM		
350	YFM350 MOTO-4	1987-95	CB14A-A1-SM		
350	YFM350 BIG BEAR	1987-99	CB14A-A1-SM		
350	YFM350 WOLVERINE	1995-05	CB12C-A-SM		
350	YFM350 WOLVERINE	2006-08	CBTX14AH-BS	CX14AH	ULT3
350	YFM350 WARRIOR	1987-03	CB12C-A-SM		
400	YFM400 BIG BEAR	2000-12	CBTX20L-BS	CX20L	ULT4
400	YFM400 GRIZZLY	2007-08	CBTX14AH-BS	CX14AH	ULT3
400	YFM400 KODIAK	1993-95	CB14A-A1-SM		
400	YFM400 KODIAK	1996-02	CBTX20L-BS	CX20L	ULT4
400	YFM400 KODIAK	2003-06	CBTX14AH-BS	CX14AH	ULT3
450	YFM450 GRIZZLY	2007-14	CBTX20L-BS	CX20L	ULT4
450	YFM450 KODIAK	2003-06	CBTX20L-BS	CX20L	ULT4
450	YFM450 WOLVERINE	2003-10	CBTX20L-BS	CX20L	ULT4
450	YFZ450	2004-09	CT7B-BS		ULT1
450	YFZ450	2012-13	CT7B-BS		ULT1
450	YFZ450R/X	2009-22	CTZ7S-BS		ULT1
550	YFM550 GRIZZLY	2009-14	CBTX20L-BS	CX20L	ULT4
600	YFM600 GRIZZLY	1998-01	CBTX20L-BS	CX20L	ULT4
660	YFM660 GRIZZLY	2002-08	CBTX20L-BS	CX20L	ULT4
660	YFM660 RAPTOR	2001-05	CBTX14-BS	CX14	ULT3
700	YFM700 KODIAK	2016-22	CBTX20L-BS	CX20L	ULT4
700	YFM700 GRIZZLY	2007-22	CBTX20L-BS	CX20L	ULT4
700	YFM700R RAPTOR	2006-22	CT9B-BS	CX9	ULT1
450	RHINO 450	2004-09	CALL		
660	RHINO 660	2004-07	CALL		
700	PRO HAULER 700	2004-	CALL		ULT4/ULT5
1000	PRO HAULER 1000	2004-	CALL		ULT4/ULT5
700	RHINO 700	2008-13	CALL		ULT4/ULT5
700	VIKING 700	2014-22	CALL		ULT4/ULT5
700	WOLVERINE 700	2016-22	CALL		ULT4/ULT5
1000	YXZ1000R SXS	2016-22	CALL		ULT4/ULT5
400	YFM400 KODIAK	2003-06	CBTX14AH-BS	CX14AH	ULT3
450	YFM450 GRIZZLY	2007-14	CBTX20L-BS	CX20L	ULT4
450	YFM450 KODIAK	2003-06	CBTX20L-BS	CX20L	ULT4
450	YFM450 WOLVERINE	2003-10	CBTX20L-BS	CX20L	ULT4
450	YFZ450	2004-09	CT7B-BS		ULT1
450	YFZ450	2012-13	CT7B-BS		ULT1
450	YFZ450R/X	2009-23	CTZ7S-BS/ CBTX5L-BS		ULT1
550	YFM550 GRIZZLY	2009-14	CBTX20L-BS	CX20L	ULT4
600	YFM600 GRIZZLY	1998-01	CBTX20L-BS	CX20L	ULT4
660	YFM660 GRIZZLY	2002-08	CBTX20L-BS	CX20L	ULT4
660	YFM660 RAPTOR	2001-05	CBTX14-BS	CX14	ULT3
700	YFM700 KODIAK	2016-23	CBTX20L-BS	CX20L	ULT4
700	YFM700 GRIZZLY	2007-23	CBTX20L-BS	CX20L	ULT4
700	YFM700R RAPTOR	2006-23	CT9B-BS		ULT1
450	RHINO 450	2004-09	TBD	TBD	TBD
660	RHINO 660	2004-07	TBD	TBD	TBD
700	RHINO 700	2008-13	TBD	TBD	TBD
700	VIKING 700	2014-23	TBD	TBD	TBD
700	WOLVERINE 700	2016-18	TBD	TBD	TBD
850	WOLVERINE 850	2019-23	TBD	TBD	TBD
1000	WOLVERINE	2021-23	TBD	TBD	TBD
1000	YXZ1000R SXS	2016-23	TBD	TBD	TBD

VERTEX (formerly known as Wrench Rabbit) Complete Engine Rebuild Kits save you time by eliminating the need to look up and compile a list of OEM parts. Saves you the worry of missing components. The kits feature a combination of leading brands of engine parts in one box (Hot Rods, Vertex, Hot Cams).

Includes everything needed to rebuild a complete engine (excludes the top end) in one convenient kit.



- Hot Rods heavy duty crankshaft
- Hot Rods counter balancer bearing kit, when applicable
- Hot Rods main bearing and seal kit
- Hot Rods transmission bearing kit
- Hot Rods water pump rebuild kit
- Vertex piston kit
- Vertex complete gasket and oil seal kit (does not include mechanical seals)
- Hot Rods wrist pin bearing, when applicable
- Hot Cams cam chain, when applicable

HONDA DIRT BIKE

MODEL	YEAR	PART NO.	DESCRIPTION
CR-80R	1992-02	WR101-010	With Std. Piston
CR-85R	2003-04	WR101-104	With Std. Piston
CR-85R	2005-07	WR101-018	With Std. Piston
CR-125R	1990-91	WR101-130	With Std. Piston
CR-125R	1992-95	WR101-131	With Std. Piston
CR-125R	1996-97	WR101-132	With Std. Piston
CR-125R	1998-99	WR101-096	With Std. Piston
CR-125R	2000	WR101-101	With Std. Piston
CR-125R	2001-02	WR101-097	With Std. Piston
CR-125R	2003	WR101-098	With Std. Piston
CR-125R	2004	WR101-099	With Std. Piston
CR-125R	2005-07	WR101-100	With Std. Piston
CRF-150R	2007-09	WR101-177	With Std. Piston
CRF-150R	2010-20	WR101-178	With Std. Piston
CR-250R	1992-94	WR101-012	With Std. Piston
CR-250R	1995-96	WR101-013	With Std. Piston
CR-250R	1997-01	WR101-014	With Std. Piston
CR-250R	2002-04	WR101-015	With Std. Piston
CR-250R	2005-07	WR101-016	With Std. Piston
CRF-250R	2008-09	WR101-023	With Std. Piston
CRF-250R	2010-13	WR101-024	With Std. Piston
CRF-250R	2014-15	WR101-153	With Std. Piston
CRF-250R	2016-17	WR101-219	With Std. Piston
CRF-450R	2007-08	WR101-028	With Std. Piston
CRF-450R	2009-12	WR101-030	With Std. Piston
CRF-450R	2013-16	WR101-150	With Std. Piston
CRF-450R	2017-18	WR00006	With Std. Piston
CRF-450RX	2017-18	WR00006	With Std. Piston
CR-500R	1989-01	WR101-017	With Std. Piston
CR-500R	1989-01	WR00019	With +1.00mm Piston
CR-500R	1989-01	WR00020	With +1.50mm Piston

HUSQVARNA DIRT BIKE

MODEL	YEAR	PART NO.	DESCRIPTION
TC-65	2017-20	WR101-055	With Std. Piston
TC-85	2014-17	WR101-148	With Std. Piston
TC-250	2014-15	WR101-067	With Std. Piston
TE-250	2014	WR101-091	With Std. Piston
TE-250	2017-18	WR00072	With Std. Piston
TE-250i	2018-19	WR00072	With Std. Piston
FC-250	2014-15	WR101-161	With Std. Piston

KAWASAKI DIRT BIKE

MODEL	YEAR	PART NO.	DESCRIPTION
KX-65	2000-01	WR101-047	With Std. Piston
KX-65	2002-04	WR101-049	With Std. Piston
KX-65	2005	WR101-050	With Std. Piston
KX-65	2006-20	WR101-051	With Std. Piston
KX-80	1991-97	WR101-105	With Std. Piston
KX-80	1998-01	WR101-011	With Std. Piston
KX-85	2001-04	WR101-109	With Std. Piston
KX-85	2005	WR101-110	With Std. Piston
KX-85	2006	WR101-133	With Std. Piston
KX-85	2007-13	WR101-052	With Std. Piston
KX-85	2014-24	WR101-170	With Std. Piston
KX-100	1995-00	WR101-108	With Std. Piston
KX-100	2001-04	WR101-106	With Std. Piston
KX-100	2005	WR101-107	With Std. Piston
KX-100	2006-13	WR101-134	With Std. Piston
KX-100	2014-20	WR101-163	With Std. Piston
KX-125	2003-04	WR101-036	With Std. Piston
KX-125	2005	WR101-037	With Std. Piston
KX-250	1994-96	WR101-117	With Std. Piston
KX-250	1997	WR101-112	With Std. Piston
KX-250	1998-01	WR101-113	With Std. Piston
KX-250	2002-03	WR101-114	With Std. Piston
KX-250	2004	WR101-115	With Std. Piston
KX-250	2005	WR00004	With Std. Piston
KX-250F	2006-08	WR101-040	With Std. Piston
KX-250F	2009	WR101-041	With Std. Piston
KX-250F	2010	WR101-042	With Std. Piston
KX-250F	2011-13	WR101-043	With Std. Piston
KX-250F	2014-16	WR101-175	With Std. Piston
KLX-400R	2003-04	WR101-058	With Std. Piston
KLX-450R	2008-09	WR101-118	With Std. Piston
KX-450F	2010-12	WR101-046	With Std. Piston
KX-450F	2013-14	WR101-144	With Std. Piston
KX-450F	2015	WR101-174	With Std. Piston

KTM DIRT BIKE

MODEL	YEAR	PART NO.	DESCRIPTION
50 SX PRO JR/SR	2004-05	WR00003	With Std. Piston
50 SX	2006-08	WR00003	With Std. Piston
50 SX	2009-12	WR101-158	With Std. Piston
50 SX	2013-20	WR101-159	With Std. Piston
65 SX	2003-08	WR101-054	With Std. Piston
65 SX	2009-23	WR101-055	With Std. Piston
85 SX	2003-12	WR101-056	With Std. Piston
85 SX	2013-17	WR101-148	With Std. Piston
105 SX	2004-11	WR101-053	With Std. Piston
105 XC	2008-09	WR101-053	With Std. Piston
200 SX	2003-04	WR101-128	With Std. Piston
200 XC	2006-09	WR101-128	With Std. Piston
250 SX	2003-04	WR101-120	With Std. Piston
250 SX	2005	WR101-035	With Std. Piston
250 SX	2006	WR101-066	With Std. Piston
250 SX	2007-16	WR101-067	With Std. Piston
250 SX-F	2005	WR00030	With Std. Piston
250 SX-F	2006-08	WR00031	With Std. Piston
250 SX-F	2009-10	WR101-122	With Std. Piston
250 SX-F	2011	WR101-123	With Std. Piston
250 SX-F	2012	WR101-162	With Std. Piston
250 SX-F	2013	WR101-160	With Std. Piston
250 SX-F	2014-15	WR101-161	With Std. Piston
250 XC	2006	WR101-151	With Std. Piston
250 XC	2007	WR101-090	With Std. Piston
250 XC	2008-15	WR101-091	With Std. Piston
250 XC	2018-19	WR00072	With Std. Piston
250 XC-F	2011-12	WR101-143	With Std. Piston
250 XC-F	2013	WR101-160	With Std. Piston
250 XC-F	2014-15	WR101-161	With Std. Piston
250 XCF-W	2012	WR101-143	With Std. Piston
250 XCF-W	2013	WR101-162	With Std. Piston
250 XC-W	2006	WR101-151	With Std. Piston
250 XC-W	2007	WR101-091	With Std. Piston
250 XC-W	2008-16	WR101-091	With Std. Piston
250 XC-W	2017-18	WR00069	With Std. Piston
250 XC-W TPI	2018-19	WR00069	With Std. Piston

SUZUKI DIRT BIKE

MODEL	YEAR	PART NO.	DESCRIPTION
RM-65	2003-04	WR101-049	With Std. Piston
RM-85	2005-20	WR101-069	With Std. Piston
RM-100	2003	WR101-106	With Std. Piston
RM-125	2001-03	WR101-186	With Std. Piston
RM-125	2004-07	WR101-187	With Std. Piston
RM-250	2003-04	WR101-063	With Std. Piston
RM-250	2005	WR101-064	With Std. Piston
RM-250	2006-08	WR101-065	With Std. Piston
RM-Z 250	2004	WR101-070	With Std. Piston
RM-Z 250	2005-06	WR101-072	With Std. Piston
RM-Z 250	2007-09	WR101-073	With Std. Piston
RM-Z 250	2010-12	WR101-074	With Std. Piston
RM-Z 250	2013-15	WR101-169	With Std. Piston
DR-Z 400	2000-04	WR101-058	With Std. Piston
DR-Z 400 E	2000-07	WR101-058	With Std. Piston
DR-Z 400 S, SM	2005-20	WR101-058	With Std. Piston
RM-Z 450	2008-12	WR101-076	With Std. Piston
RM-Z 450	2013-14	WR101-149	With Std. Piston

YAMAHA DIRT BIKE

MODEL	YEAR	PART NO.	DESCRIPTION
YZ-80	1993-01	WR101-124	With Std. Piston
YZ-85	2002-18	WR101-089	With Std. Piston
YZ-125	2001	WR101-125	With Std. Piston
YZ-125	2002-04	WR101-094	With Std. Piston
YZ-125	2005-21	WR101-081	With Std. Piston
YZ-250	1999-00	WR101-126	With Std. Piston
YZ-250	2001	WR101-127	With Std. Piston
YZ-250	2002	WR101-095	With Std. Piston
YZ-250	2003-24	WR101-082	With Std. Piston
YZ-250 X	2016-24	WR101-082	With Std. Piston
YZ-250F	2003-04	WR101-083	With Std. Piston
YZ-250F	2005-07	WR101-084	With Std. Piston
YZ-250F	2008-13	WR101-085	With Std. Piston
YZ-250F	2014-15	WR101-168	With Std. Piston
YZ-250F	2016-18	WR00008	With Std. Piston
YZ-450F	2003-05	WR101-086	With Std. Piston
YZ-450F	2006-09	WR101-087	With Std. Piston
YZ-450F	2010-13	WR101-088	With Std. Piston
YZ-450F	2014-17	WR101-181	With Std. Piston

HONDA ATV

MODEL	YEAR	PART NO.	DESCRIPTION
TRX-250 EX	2003-08	WR00011	With Std. Piston
TRX-250 TE RECON	2002-19	WR00011	With Std. Piston
TRX-250 TM RECON	2002-19	WR00011	With Std. Piston
TRX-250 X	2009-19	WR00011	With Std. Piston
TRX-350 FE, FM	2000-06	WR00007	With Std. Piston
TRX-350 TE, TM	2000-06	WR00007	With Std. Piston
TRX-400 EX, X	2005-14	WR101-196	With Std. Piston
TRX-400 EX, X	2005-14	WR101-197	With +1.0mm Piston
TRX-400 EX, X	2005-14	WR101-198	With +2.0mm Piston
TRX-400 EX, X	2005-14	WR101-199	With +3.0mm Piston
TRX-420 FE/FM/FPE/TE	2012-13	WR00012	With Std. Piston
TRX-420 FPM/TM	2012-13	WR00038	With Std. Piston
TRX-450 ER	2006-14	WR101-032	With Std. Piston
TRX-450R	2004-05	WR101-031	With Std. Piston
TRX-450R	2006-09	WR101-032	With Std. Piston
TRX-500 FE	2005-11	WR00036	With Std. Piston
TRX-500 FE	2012-13	WR00039	With Std. Piston
TRX-500 FM	2005-11	WR00037	With Std. Piston
TRX-500 FM, FPM	2012-13	WR00059	With Std. Piston
TRX-500 TM	2005-06	WR00037	With Std. Piston

KAWASAKI ATV UTV

MODEL	YEAR	PART NO.	DESCRIPTION
KFX-400	2005-06	WR101-061	With Std. Piston
KFX-450R	2008-14	WR101-138	With Std. Piston
KFX-700 V-Force	2004-09	WR00029	With Std. Pistons
KVF-700 Prairie	2004-06	WR00029	With Std. Pistons
KVF-750 Brute Force	2005-11	WR101-164	With Std. Pistons
KVF-750 Brute Force	2012-14	WR101-165	With Std. Pistons
KVF-750 Brute Force	2015-20	WR101-176	With Std. Pistons
KRF-750 Teryx 4x4	2008-11	WR101-164	With Std. Pistons

POLARIS ATV UTV

MODEL	YEAR	PART NO.	DESCRIPTION
ATP 500 4x4	2004-05	WR00063	With Std. Piston
ATP 500 4x4	2004-05	WR00064	With +.50mm Piston
ATP 500 4x4	2004-05	WR00065	With +1.0mm Piston
Ranger 500 4x4	2006	WR00066	With Std. Piston
Scrambler 500 2x4	2007-09	WR00063	With Std. Piston
Scrambler 500 2x4	2007-09	WR00064	With +.50mm Piston
Scrambler 500 2x4	2007-09	WR00065	With +1.0mm Piston
Scrambler 500 4x4	2003-12	WR00063	With Std. Piston
Scrambler 500 4x4	2003-12	WR00064	With +.50mm Piston
Scrambler 500 4x4	2003-12	WR00065	With +1.0mm Piston
Sportsman 500 HO 4x4	2003-13	WR00066	With Std. Piston
Sportsman 500 HO 4x4	2003-13	WR00067	With +.50mm Piston
Sportsman 500 HO 4x4	2003-13	WR00068	With +1.0mm Piston
Sportsman 500 X2	2006-09	WR00066	With Std. Piston
Sportsman 500 X2	2006-09	WR00067	With +.50mm Piston
Sportsman 500 X2	2006-09	WR00068	With +1.0mm Piston
Sportsman Touring 500	2008-09	WR00066	With Std. Piston
Sportsman Touring 500	2008-09	WR00067	With +.50mm Piston
Sportsman Touring 500	2008-09	WR00068	With +1.0mm Piston
Sportsman Forest 500 4x4	2011-14	WR00066	With Std. Piston
Sportsman Forest 500 4x4	2011-14	WR00067	With +.50mm Piston
Sportsman Forest 500 4x4	2011-14	WR00068	With +1.0mm Piston
Ranger 700 4x4 ,XP, Crew	2005-09	WR00028	With Std. Pistons
Ranger 700 6x6	2006-09	WR00028	With Std. Pistons
Sportsman 700 4x4, X2	2005-08	WR00028	With Std. Pistons
Ranger 800 4x4	2008-10	WR101-057	With Std. Pistons
Ranger 800 6x6	2010	WR101-057	With Std. Pistons
Ranger 800 4x4 Crew, XP	2011-14	WR101-185	With Std. Pistons
Ranger 800 6x6	2011-17	WR101-185	With Std. Pistons
RZR 800	2008-10	WR101-057	With Std. Pistons
RZR 800	2011-14	WR101-185	With Std. Pistons
RZR S 800	2009	WR101-057	With Std. Pistons
RZR 4 800	2010	WR101-057	With Std. Pistons
RZR 4 800	2011-14	WR101-185	With Std. Pistons
Sportsman 800 4x4	2005-10	WR101-057	With Std. Pistons
Sportsman 800 X2	2007-09	WR101-057	With Std. Pistons
Sportsman Touring 800	2008-09	WR101-057	With Std. Pistons
Sportsman 800 6x6	2008-10	WR101-057	With Std. Pistons
Sportsman 800 4x4, 6x6	2011-14	WR00060	With Std. Pistons
Scrambler 850 HO XP EPS	2013	WR00046	With Std. Pistons
Scrambler 850	2014-18	WR00048	With Std. Pistons
Sportsman 850 High Lifter	2016-19	WR00048	With Std. Pistons
Sportsman 850 SP	2015-18	WR00048	With Std. Pistons
Sportsman 850 Touring SP	2015-18	WR00048	With Std. Pistons
Sportsman 850 Touring EPS	2014	WR00048	With Std. Pistons
Sportsman XP EPS HO	2014-15	WR00048	With Std. Pistons
ACE 900	2016	WR00040	With Std. Pistons
ACE 900 EPS XC	2017	WR00009	With Std. Pistons
ACE 900 EPS XC	2018-19	WR00043	With Std. Pistons
Ranger 900 XP	2013-14	WR00042	With Std. Pistons
Ranger 900 4x4 Crew	2014-15	WR00042	With Std. Pistons
Ranger 900 4x4 Crew	2016	WR00040	With Std. Pistons
Ranger 900 4x4 Crew	2017	WR00009	With Std. Pistons
Ranger 900 4x4 Crew	2018-19	WR00043	With Std. Pistons
Ranger 900 XP	2016	WR00040	With Std. Pistons
Ranger 900 XP	2017	WR00009	With Std. Pistons
Ranger 900 XP	2018-19	WR00043	With Std. Pistons
RZR 900 XP	2011-12	WR00044	With Std. Pistons
RZR 4 900 XP	2012	WR00044	With Std. Pistons

POLARIS ATV UTV (Continued)

RZR 900 50, 55, 60 Inch	2015	WR00042	With Std. Pistons
RZR 900 50, 55, 60 Inch	2016	WR00040	With Std. Pistons
RZR 900 50, 55, 60 Inch	2017	WR00009	With Std. Pistons
General 1000 EPS	2016-17	WR00054	With Std. Pistons
General 1000 EPS	2018-20	WR00053	With Std. Pistons
Ranger 1000 EPS, XP	2019	WR00055	With Std. Pistons
RZR 1000	2016-17	WR00054	With Std. Pistons
RZR 1000	2018-20	WR00053	With Std. Pistons
RZR 1000 RS1	2018-20	WR00053	With Std. Pistons
RZR S4 1000	2019	WR00053	With Std. Pistons
RZR XP 4 1000	2019-20	WR00053	With Std. Pistons

SUZUKI ATV

MODEL	YEAR	PART NO.	DESCRIPTION
LT-Z400	2009-14	WR101-062	With Std. Piston

YAMAHA ATV UTV

MODEL	YEAR	PART NO.	DESCRIPTION
YFS-200 Blaster	1988-06	WR101-155	With Std. Piston
YFS-200 Blaster	1988-06	WR101-200	With +.50mm Piston
YFS-200 Blaster	1988-06	WR101-201	With +1.0mm Piston
YFS-200 Blaster	1988-06	WR101-202	With +1.50mm Piston
YFS-200 Blaster	1988-06	WR101-203	With +2.0mm Piston
YFZ-350 Banshee	1987-06	WR101-077	With Std. Pistons
YFZ-350 Banshee	1987-06	WR101-204	With +.50mm Pistons
YFZ-350 Banshee	1987-06	WR101-205	With +1.0mm Pistons
YFZ-350 Banshee	1987-06	WR101-206	With +1.50mm Pistons
YFZ-350 Banshee	1987-06	WR101-207	With +2.0mm Pistons
YFM-350 Warrior	1987-04	WR101-208	With Std. Piston
YFM-350 Warrior	1987-04	WR101-209	With +.50mm Piston
YFM-350 Warrior	1987-04	WR101-210	With +1.0mm Piston
YFM-350 Raptor	2004-13	WR101-208	With Std. Piston
YFM-350 Raptor	2004-13	WR101-209	With +.50mm Piston
YFM-350 Raptor	2004-13	WR101-210	With +1.0mm Piston
YFZ-450	2004-05	WR101-078	With Std. Piston
YFZ-450	2006-09	WR101-079	With Std. Piston
YFZ-450	2012-13	WR101-079	With Std. Piston
YFZ-450R	2009-13	WR101-147	With Std. Piston
YFZ-450 X	2010-11	WR101-147	With Std. Piston
YFZ-450R	2014-20	WR00062	With Std. Piston
YFM-660 Grizzly 4x4	2002-08	WR101-137	With Std. Piston
YFM-660 Grizzly 4x4	2002-08	WR101-211	With +.50mm Piston
YFM-660 Grizzly 4x4	2002-08	WR101-212	With +1.0mm Piston
YFM-660R Raptor	2001-05	WR101-182	With Std. Piston
YFM-660R Raptor	2001-05	WR101-213	With +.50mm Piston
YFM-660R Raptor	2001-05	WR101-214	With +1.0mm Piston
YXR-660F Rhino	2004-07	WR101-137	With Std. Piston
YXR-660F Rhino	2004-07	WR101-211	With +.50mm Piston
YXR-660F Rhino	2004-07	WR101-212	With +1.0mm Piston
YFM-700 Grizzly 4x4	2007-13	WR101-136	With Std. Piston
YFM-700R Raptor	2006-14	WR101-135	With Std. Piston
YFM-700R Raptor	2015-20	WR00061	With Std. Piston
YXR-700 F Rhino	2008-13	WR101-136	With Std. Piston

PRO-X CONNECTING ROD DIMENSIONS

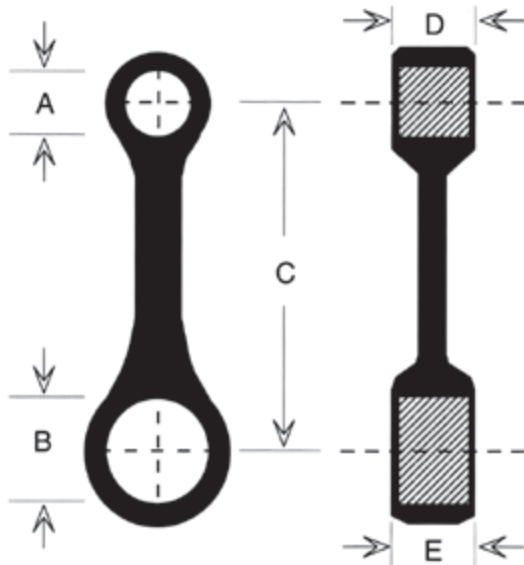

PART NUMBER	A	B	C	D	E	B.E. PIN OD X LTH	THRUST WASHERS
03.1000	14	22	75	12	12	16 x 33	Yes
03.1003	17	22	80	13.50	13.50	16 x 40	Yes
03.1005	17	22	91	13.50	13.50	16 x 41	Yes
03.1010	17	24	80	12	12	18 x 33.50	Yes
03.1050	13	28	91	14	14	23 x 39	None
03.1075	13	30.10	94	14	14	25.10 x 39	None
03.1080	13	26	91	14	14	21 x 35	None
03.1090	13	28	94	14	14	23 x 39	None
03.1102	17	24	91	13.50	13.50	18 x 40.75	Yes
03.1103	19	26	100	14	14	20 x 48	Yes
03.1176	15	38	105.50	18	18	30 x 54.05	None
03.1200	20	28	100	16	16	22 x 55	Yes
03.1210	19	31	104	16.70	16.70	24 x 49	Yes
03.1227	14	32	75.50	14	15.80	25 x 50	Yes
03.1260	14	36	95	14	14	28 x 42.40	None
03.1280	14	33	91	14	14	26 x 43.50	None
03.1348	16	38	91.50	16	19.85	30 x 54.90	Yes
03.1353	19	41	113	20	29	33 x 61	None
03.1355	17	41	106.50	18	18	32 x 56	Yes
03.1358	17	41	102.50	17.80	17.80	32 x 58	Yes
03.1363	15	38	110	18	18	30 x 54	None
03.1405	19	42	105.50	18	19.75	34 x 65	Yes
03.1409	19	41	102	18	19.80	33 x 60.85	Yes
03.1417	19	43	102	18 / 15.70	19.80	35 x 67	Yes
03.1553	21	42	141	20	20	34 x 60	Yes
03.6011	15	22	85	14	12	16 x 36	Yes
03.6029	15	24	88	12.90	14.90	18 x 54.30	Yes
03.6104	18	28	96	12.90	16	22 x 46	Yes
03.6113	18	26	96	14	15	20 x 46	Yes
03.6209	19	26	110	14.85	14.85	20 x 55.90	Yes
03.6226	19	28	110	16	16	22 x 55.90	Yes
03.6248	20	28	118	15.90	15.90	22 x 55	Yes
03.6310	22	30	132	17	17	24 x 59.60	Yes
03.6326	16	38	98	17.90	17.90	30 x 53.60	None
03.6333	16	30	98	15 / 10.80	18	30 x 56	None
03.6337	16	30	92	15 / 10.80	18	30 x 56	None

PART NUMBER	A	B	C	D	E	B.E. PIN OD X LTH	THRUST WASHERS
03.6343	16	30	86	15 / 10.80	18	30	None
03.6351	18	40	102	16.90	19.90	32 x 59.90	None
03.6363	18	32	102	17 / 13.50	20	32 x 59.90	None
03.6366	18	32	96	17 / 13.40	20	32 x 59.90	None
03.6423	20	40	119	19.90	19.90	32 x 64.60	None
03.6427	19	42	107.40	17	19.90	35 x 63.90	None
03.6428	19	42	114	19.80	19.90	35 x 62.70	None
03.6432	19	42	114	14.70	19.90	35 x 62.70	None
03.6433	19	35	114	20 / 15	20	35 x 62.70	None
03.6436	19	35	107.60	20 / 15	20	35 x 61.90	None
03.6508	20	42	106.70	17.90	19.90	35 x 63.90	None
03.6512	19	42	122.40	19.90	19.90	35 x 62.70	None
03.6528	19	42	120.80	19.90	19.90	35 x 62.70	None
03.4005	18	27	96	18	15	20 x 49.90	Yes
03.4250	21	29	106	17	17	22 x 54	Yes
03.4340	16	38	92.50	15	18	30 x 55.85	Yes
03.4342	16	38	92.50	15	19	30 x 55.85	None
03.4347	16	30	92.50	15	19	30 x 55.85	None
03.4351	16	30	92.50	15	19	30 x 55.85	None
03.4409	19	42	101	18	22	34 x 62.10	None
03.4419	19	34	101	18	22	34 x 62.10	None
03.3000	14	22	80	12	12	16 x 40	Yes
03.3001	16	22	80	12	12	16 x 40	Yes
03.3003	14	22	75	12	12	16 x 33.50	None
03.3005	18	25	100	18	16	19 x 56	Yes
03.3006	18	28	100	18	15.85	22 x 53	Yes
03.3007	20	28	105	16.35	16.35	22 x 50	None
03.3018	21	28	110	17	17	22 x 56	Yes
03.3203	18	28	100	18	16	22 x 53	Yes
03.3349	20	28	105	16.40	16.40	22 x 47	None
03.3408	19	42	105.60	16.50	19.75	34 x 60.80	None
03.3504	18	25	100.10	18	15.85	19 x 50	Yes
03.3505	18	28	100	18	16	22 x 50	Yes
03.2001	15	24	84	15.50	11.60	18 x 43.50	Yes
03.2002	15	24	84	15.50	11.50	18 x 37	Yes
03.2008	14	22	80	11.75	11.75	16 x 37	None
03.2009	21	29	105	17	17	22 x 56.40	Yes
03.2010	21	29	105	17	17	-	Yes
03.2018	16	24	90	14	14	18 x 43.30	Yes
03.2020	21	29	110	18	16	-	Yes
03.2021	21	29	110	18	17	-	Yes
03.2025	20	28	110	16	16	22 x 50.75	Yes
03.2119	18	26	92	14	14	20 x 43.25	Yes
03.2250	20	28	105	18	16	22 x 54.50	Yes
03.2251	20	28	110	16	16	22 x 54.40	Yes
03.2255	21	29	110	18	16	22 x 54.50	Yes
03.2308	17	40	100.50	20	20	32 x 67.75	None
03.2320	16	37	101.55	20	20	30 x 55	None
03.2325	16	37	100.50	20	20	30 x 55	None
03.2414	16	38	92.50	15	18	30 x 54.80	Yes
03.2432	18	42	103.50	18	21	34 x 60.75	Yes
03.2439	20	45	108	18	23	36 x 62.80	None
03.2444	20	45	108.25	18	23	36 x 62.80	None
03.2576	20	42	145.20	23.80	23.80	34 x 73.70	None

PRO-X CONNECTING ROD DIMENSIONS



GAS GAS
HONDA
HUSQVARNA
KAWASAKI
KTM
SUZUKI
YAMAHA
DIRT BIKE SLEEVES
STREET BIKE SLEEVES
ACCESSORIES
TECHNICAL

PART NUMBER	A	B	C	D	E	B.E. PIN OD X LTH	THRUST WASHERS
03.2600	22	43	135.50	22	22	35 x 74	None
03.5215	19	36	125	17	20	28 x 48	Yes
03.5316	22	40	130	22	22	32 x 60	Yes
03.5507	25	30	125	17	17	24 x 52	Yes
03.6217	19	30	105	16	16	24 x 55	Yes
03.6319	22	30	125	17	17	24 x 58.10	Yes
03.6336	16	38	98	15	18	30 x 56.55	None
03.6340	14	40	92	17	17	32 x 56	None
03.6425	20	42	106	18	19.80	34 x 58.30	None
03.6505	20	38	110	18	18	30 x 56.50	None
03.6688	23	32.30	125.05	15.75	15.75	24.30 x 54	Yes
03.7202	19	26	110	14.85	14.85	20 x 49	Yes
03.7204	15	33	87	16	16	26 x 39	None
03.7220	20	28	110	16	16	22 x 51	Yes
03.7313	22	31	125	20	17	24 x 59	Yes
03.7318	22	31	125	20	17	24 x 59	Yes
01351	15	38	103.50	16	16	30 x 54	None
01352	15	38	103.50	18	18	30 x 54	Yes
01354	17	41	126.50	20	20	33 x 60	Yes
01356	17	41	105	18	18	32 x 58	Yes
01357	17	41	122	20	20	33 x 60	Yes
01563	24	48	134	23	23	38 x 65	Yes
01564	24	45	132	23	23	36 x 71	None
01565	40	43	122.50	20	20	34 x 66	None
01573	22	32	133	22	20	24 x 58.50	Yes
02514	22	30	115	13	13	24 x 45	Yes
02515	22	30	115	15	15	24 x 47	Yes
02522	22	30	125	16.90	16.90	24 x 52	Yes
02528	22	29	110	18	18	22 x 53	Yes
02529	25	36	125	21	21	27 x 60.50	Yes
02531	25	32	125	20	20		Yes
02534	24	33	125	18	18	26 x 55	Yes
02536	24	33	125	18	18	26 x 53	Yes
02537	24	35	140	17.85	17.85	28 x 55	Yes
02542	25	36	140	20	20	28 x 57	Yes
02663	22	31	125	17	17	24 x 65	Yes
02664	22	31	125	17	17	24 x 57	Yes
04301	20	28	105	16	16	22 x 54.50	Yes
04303	20	28	100	16	16	22 x 54	Yes
04308	19	41	112.50	20.30	20	33 x 57.75	Yes
04907	23	50	125	22	22	40 x 73.80	None
04908	18	42	103	18	21	34 x 60.75	-
04909	20	42	101.50	18	21	34 x 60.75	Yes
04910	19	42	101	18	20	34 x 60.10	None
04911	15	24	88	12.90	14.90	18 x 42	Yes
04912	18	42	103.50	18	20	34 x 60.75	None
04913	21	29	110	18	17	-	Yes
04914	19	42	106.10	18.40	19.75	34 x 60.75	None
04915	23	50	140.25	23	23	38 x 65	Yes
04916	19	29	102	16	17	22 x 54.50	Yes
04917	16	38	90	15	17.80	30 x 53	Yes
04918	19	28	110	16	16	22 x 53	Yes
04919	16	38	92.50	15	18	30 x 54.80	None
04920	19	29	105	16	17	22 x 54.50	Yes

PART NUMBER	A	B	C	D	E	B.E. PIN OD X LTH	THRUST WASHERS
04921	20	43	106.80	19.85	21.80	35 x 61.80	None
04922	20	42	102.50	18	20	34 x 60.75	None
04923	22	30	125	17	17	24 x 60	Yes
04924	22	50	141.50	23	23	40 x 65	Yes
04925	20	43	129	21.90	21.90	35 x 64.75	Yes
04926	22	30	125	17	17	24 x 58	Yes
04928	23	30	125	20	20	24 x 59.30	Yes
04929	19	29	104	17	17	22 x 55	Yes
04930	16	38	93.50	15	18	30 x 54.80	None
04931	22	32	125.25	20	16.50	25 x 59.60	Yes
04932	16	23	85	14	14	17 x 37	Yes
04933	15	24	88	13	15	18 x 56	Yes
04934	18	26	93.50	14	14	20 x 45	Yes
04935	19	42	105.50	18 / 15	19.75	34 x 61	None
04936	16	40	93.50	15	18	32 x 54.80	None
04937	18	42	103.50	18	20	34 x 60.75	None
04939	22	45	136.50	22	22	37 x 73.80	None
04940	19	29	104	17	17	22 x 51.20	Yes
04941	18	29	92	16	16	22 x 46	Yes
04942	22	31	125	20	17	24 x 59	Yes
04943	19	28	102	18	16	22 x 53	Yes
04944	18	42	102	18	20	34 x 60.75	None
04946	19	42	102	18	20	34 x 60.75	None
04949	22	30	132	17	17	24 x 59.60	Yes
04953	20	29	98	17	17	22 x 54.50	Yes
04959	19	29	104	16	16	22 x 54	Yes
04963	21	29	110	18	17	22 x 56.40	Yes
04965	20	28	115	16	16	22 x 51	Yes
04966	19	28	105	18	16	22 x 53	Yes
04967	22	32	125	22	20	24 x 58.50	Yes
04968	23	31	125	20	20	25 x 59.90	Yes
04970	19	29	106	17	17	22 x 51	Yes
04971	22	31	130.30	16.75	16.75	24 x 59.60	Yes
04972	18	26	97	14.15	14.15	20 x 45	Yes
04973	18	29	92	16	14	22 x 46	Yes
04976	18	24	93.60	16	14	18 x 45	None
04977	18	26	93.60	16	14	20 x 45	None
04979	18	26	96	14	14	20 x 43.25	Yes
04980	22	31	125.30	20	16.75	24 x 59.60	Yes
04981	23	31	130	20	20	25 x 60	Yes
04982	16	27	85	14	14	20 x 46	Yes
04983	23	30	128	20	20	24 x 58	Yes
04984	23	30	125.50	20	20	24 x 58	Yes
04986	21	29	109	17	17	22 x 51	Yes
04988	19	28	100	18	16	22 x 53	Yes
04990	20	29	105	16	17	22 x 54.50	Yes
04991	15	26	94	11.60	11.60	20 x 46	Yes
04992	17	24	90	14	14	18 x 41.30	Yes
04994	20	29	105	16	17	22 x 54.50	Yes
04995	25	35	144	24	20	26 x 67.75	Yes
04997	19	28	110	16	16	22 x 54.90	Yes
04998	22	30	129	16.85	16.85	24 x 59.75	Yes



PISTON PIN BEARINGS

(O.E.M. REPLACEMENT BEARINGS)

Piston pin bearings are manufactured by leading OEM Japanese factories. Designed to exact OEM specifications to be an OEM replacement.

Size (mm)	Rollers	Part No.
12 x 15 x 16	13 pcs	01216
12 x 16 x 15	10 pcs	01215
12 x 17 x 15	10 pcs	01203
14 x 18 x 16	12 pcs	01154
14 x 18 x 16	12 pcs	01403
14 x 18 x 17	12 pcs	01303
14 x 18 x 18	12 pcs	01257
14 x 18 x 20	11 pcs	01151
14 x 19 x 17	11 pcs	01419
15 x 19 x 17.2	14 pcs	01152
15 x 19 x 17	14 pcs	01152
15 x 19 x 19.75	14 pcs	01153
15 x 19 x 20	14 pcs	01318
15 x 20 x 18	12 pcs	01205
16 x 20 x 17.7	14 pcs	21.3349
16 x 20 x 19.5	13 pcs	01202
16 x 20 x 20	14 pcs	01217
16 x 20 x 23	13 pcs	01312
16 x 21 x 19.5	12 pcs	01310
16 x 21 x 22	12 pcs	01201
18 x 22 x 19.7	16 pcs	01298
18 x 22 x 22	15 pcs	01209
18 x 22 x 22.6	14 pcs	01181
18 x 22 x 24	14 pcs	01337
18 x 23 x 22	14 pcs	01251
18 x 23 x 23	14 pcs	01338
18 x 23 x 24	14 pcs	01401
19 x 24 x 25	13 pcs	B1036
20 x 24 x 23	16 pcs	01328
20 x 25 x 22	16 pcs	01322
20 x 25 x 24	15 pcs	01252
20 x 25 x 25	16 pcs	01320
20 x 25 x 29	15 pcs	01161
21 x 25 x 24	16 pcs	01242
22 x 27 x 23	17 pcs	01343
22 x 27 x 25	16 pcs	01326

PISTON PINS

(O.E.M. REPLACEMENT PINS)

ProX offers a wide range of piston pins in many sizes. Chromed piston pins are designed for each specific application. Pins are precisely machined and heat treated to achieve hardness and properties to withstand all conditions.

Size (mm)	Part No.
10 x 33.00	04.1033
12 x 30.50	04.1230.5
12 x 31.50	04.1231.5
12 x 33.00	04.1233
12 x 33.90	04.1233.9
12 x 36.40	04.1236.4
12 x 39.00	04.1239
12 x 39.60	04.1239.6
12 x 40.00	1078
13 x 30.50	04.1330.5
13 x 38.50	04.1338.5
14 x 33.00	04.1433
14 x 36.50	04.1336.5
14 x 38.50	04.1438.5
14 x 39.00	1439
14 x 39.50	1440
14 x 40.90	04.1440.9
14 x 41.00	04.1441
14 x 42.00	1442
14 x 45.00	04.1445
14 x 45.75	0913
14 x 46.00	04.1446
14 x 47.50	04.1447.5
15 x 41.00	04.1541
15 x 43.80	04.1543.8
15 x 45.00	04.1545
15 x 45.80	04.1545.8
15 x 46.70	04.1546.7
15 x 46.90	04.1546.9
15 x 47.00	1547
15 x 50.00	1550
16 x 39.90	04.1639.9
16 x 40.00	04.1640
16 x 40.90	04.1640.9
16 x 41.40	04.1641.4
16 x 41.50	04.1641.5
16 x 41.60	04.1641.6
16 x 41.90	04.1641.9
16 x 44.40	04.1644.4
16 x 44.50	1644
16 x 45.00	04.1645
16 x 46.50	1166
16 x 46.90	04.1646.9
16 x 47.00	1087
16 x 48.00	04.1648
16 x 53.00	1653
16 x 54.00	04.1654
16 x 57.00	04.1657
16 x 59.00	04.1659
17 x 43.00	04.1743
17 x 55.00	04.1755

Size (mm)	Part No.
18 x 43.90	04.1844
18 x 44.45	04.1844.4
18 x 46.90	04.1846.9
18 x 47.00	04.1847
18 x 49.90	04.1850
18 x 50.40	04.1850.4
18 x 52.70	04.1852.7
18 x 53.30	04.1853.3
18 x 53.40	04.1853.4
18 x 55.50	1855
18 x 56.00	1149
18 x 56.90	04.1856.9
18 x 57.00	04.1857
18 x 58.00	1159
18 x 59.00	1146
19 x 47.50	04.1947.5
19 x 50.30	04.1950.3
19 x 50.40	04.1950.4
19 x 50.50	04.1950.5
19 x 58.00	1958
20 x 45.00	04.2045
20 x 47.60	04.2047.6
20 x 50.00	04.2050
20 x 50.45	04.2050.5
20 x 50.90	04.2050.9
20 x 55.50	04.2055.5
20 x 55.80	2056
20 x 57.50	04.2057.5
20 x 58.40	2058
20 x 60.40	04.2060.5
20 x 64.50	04.2064.5
20 x 65.75	04.2065.8
20 x 69.00	2069
21 x 50.90	04.2150.9
21 x 51.00	04.2151
21 x 63.50	04.2163.5
21 x 65.00	04.2165
21 x 65.00	04.2165T
22 x 50.80	04.2250.8
22 x 50.90	04.2250.9
22 x 51.00	04.2251
22 x 68.00	04.2268
22 x 69.90	04.2269.9
22 x 70.00	04.2270
22 x 72.00	04.2272
23 x 57.20	04.2357.2
23 x 63.50	04.2363.5
24 x 57.10	04.2457.1
24 x 63.50	04.2463.5
24 x 69.00	04.2469

BIG END BEARINGS

(O.E.M. REPLACEMENT BEARINGS)



ProX big-end crank pin bearings are manufactured by leading O.E.M. factories in Japan such as IKO or NTN. Made of the finest materials with designs based on latest technologies. There is a large selection of M-cage bearings as well as Flat-cage bearings for each required application.

Size (mm)	Rollers	Remarks	Part No.
16 x 22 x 13	13 pcs	Copper / M-Cage	22.162213
18 x 24 x 14	13 pcs	Silver / M-Cage	22.182414
18 x 24 x 15	15 pcs	Silver / Flat Cage	22.182415F
20 x 26 x 14	16 pcs	Silver / Flat Cage	22.202614F
20 x 26 x 15	14 pcs	Silver / M-Cage	22.202615
20 x 26 x 15	16 pcs	Silver / Flat Cage	22.202615F
20 x 27 x 14	12 pcs	Silver / M-Cage	22.202714
20 x 27 x 14	14 pcs	Silver / Flat Cage	22.202714F
22 x 28 x 16	14 pcs	Copper / M-Cage	01184
22 x 28 x 16	18 pcs	Silver / Flat Cage	22.222816F
22 x 29 x 14	16 pcs	Silver / Flat Cage	22.222914F
22 x 29 x 16	14 pcs	Silver / M-Cage	22.222916
22 x 29 x 16	15 pcs	Silver / Flat Cage	22.222916F
22 x 29 x 17	14 pcs	Silver / M-Cage	22.222917
22 x 29 x 17	16 pcs	Silver / Flat Cage	01261
24 x 30 x 17	17 pcs	Silver / M-Cage	22.243017
24 x 30 x 17	19 pcs	Silver / Flat Cage	22.243017F
24 x 30 x 20	19 pcs	Silver / Flat Cage	22.243020F
24 x 31 x 16.8	15 pcs	Silver / M-Cage	01182
24 x 31 x 17	16 pcs	Silver / Flat Cage	22.243117F
24 x 32 x 20	12 pcs	Silver / M-Cage	01315
24 x 32 x 20	16 pcs	Silver / Flat Cage	22.243220F
25 x 31 x 20	15 pcs	Silver / M-Cage	22.253120
25 x 32 x 16	17 pcs	Silver / Flat Cage	22.253216F
25 x 32 x 16.5	17 pcs	Silver / Flat Cage	22.253216.5F

Size (mm)	Rollers	Remarks	Part No.
25 x 32 x 20	16 pcs	Silver / M-Cage	01325
26 x 33 x 18	16 pcs	Silver / M-Cage	22.263318
26 x 33 x 22	15 pcs	Silver / Flat Cage	22.263322F
26 x 34 x 20	14 pcs	Silver / M-Cage	01317
26 x 35 x 20	14 pcs	Silver / Flat Cage	22.263520F
30 x 38 x 16	17 pcs	Silver / M-Cage	22.303816
30 x 38 x 18	17 pcs	Copper / M-Cage	22.303818C
30 x 38 x 18	19 pcs	Silver / Flat	22.303818F
30 x 38 x 18	19 pcs	Silver / Flat	22.303818F-1
30 x 38 x 18	17 pcs	Silver / M-Cage	22.303818S
30 x 38 x 19	20 pcs	Silver / Flat	22.303819F
30 x 38 x 20	19 pcs	Silver / Flat	22.303820F
32 x 40 x 18	20 pcs	Silver / Flat	22.324018F
32 x 40 x 20	18 pcs	Silver / M-Cage	22.324020
32 x 40 x 20	20 pcs	Silver / Flat Cage	22.324020F
33 x 41 x 20	20 pcs	Silver / Flat Cage	22.334120F
34 x 42 x 20	21 pcs	Silver / Flat Cage	22.344220F
34 x 42 x 21	21 pcs	Silver / Flat Cage	22.344221F
35 x 42 x 20	21 pcs	Silver / Flat Cage	22.354220F
35 x 43 x 20	22 pcs	Silver / Flat Cage	22.354320F
35 x 43 x 22	19 pcs	Silver / Flat-Cage	22.354322F
36 x 45 x 23	18 pcs	Silver / Flat-Cage	22.364523F-1
38 x 46 x 23	20 pcs	Silver / M-Cage	01185
40 x 50 x 22	21 pcs	Silver / Flat Cage	22.405022F
40 x 50 x 23	19 pcs	Silver / Flat Cage	22.405023F

BIG END PINS

(O.E.M. REPLACEMENT PINS)



ProX offers a wide range of big end pins in many sizes. Chromed piston pins are designed for each specific application. Pins are precisely machined and heat treated to achieve hardness and properties to withstand all conditions. Four-stroke crank pins have precision located oil canals to maximize oiling during extreme conditions.

Size (mm)	Remarks	Part No.
16 x 35.90	Hollow	06.1635.9
18 x 42.00	Hollow	06.1842
18 x 43.30	Hollow	06.1843.3
18 x 43.50	Solid	06.1843.5
18 x 54.30	-	06.1854.3
18 x 56.00	Solid	06.1856
19 x 50.00	-	06.1950
20 x 45.00	Hollow	06.2045
20 x 45.90	Hollow	06.2045.9
20 x 46.00	Hollow	06.2046
20 x 49.00	-	06.2049
22 x 45.90	Hollow	06.2245.9
22 x 46.00	Hollow	06.2246
22 x 47.00	Hollow	06.2247
22 x 51.00	Hollow	06.2251
22 x 53.00	Solid	1170
22 x 53.00	Hollow	06.2253H
22 x 54.00	Caps	06.2254
22 x 54.50	Solid	06.2254.5
22 x 54.50	Hollow	1168
22 x 55.00	Hollow	06.2255
22 x 56.50	Hollow	06.2256.5
24 x 45.00	Solid	1173
24 x 48.00	Solid	06.2448
24 x 58.00	Hollow	06.2458

Size (mm)	Remarks	Part No.
24 x 58.50	Hollow	1163
24 x 59.00	Caps	06.2459
24 x 59.30	Hollow / Caps	06.2459.3
24 x 59.60	Caps	06.2459.6
24.3 x 51.00	Solid	1177
25 x 50.00	Hollow / Caps	06.2550
25 x 59.60	Caps	06.2559.6
26 x 43.50	Solid / Lub. Hole	06.2643.5
26 x 53.00	Solid	06.2653
26 x 55.00	Solid	06.2655
26 x 58.00	Hollow	1164
26 x 67.65	Hollow	06.2668
27 x 68.30	Solid	06.2768.3
28 x 42.50	Hollow / 1 Cap	06.2842.5
28 x 55.00	Solid	06.2855
28 x 57.00	Solid	06.2857
30 x 53.00	Hollow / Caps	06.3053
30 x 53.60	Hollow / Caps	06.3053.6
30 x 54.80	Hollow / 1 Cap	06.3054.8
30 x 54.80	Hollow / 1 Cap	06.3054.8-1
30 x 55.00	Hollow / Caps	06.3055
30 x 55.90	Hollow / Caps	06.3055.9
30 x 56.00	Hollow / Caps	06.3056
30 x 56.00	Hollow / Caps	06.3056-2
30 x 56.50	Hollow / Caps	06.3056.5

Size (mm)	Remarks	Part No.
32 x 54.80	Hollow / Caps	06.3254.8
32 x 56.00	Hollow / Caps	06.3256
32 x 59.90	Hollow / Caps	06.3259.9
32 x 64.60	Hollow / Caps	06.3264.6
33 x 57.80	Hollow / Caps	06.3357.8
33 x 60.80	Hollow / Caps	06.3360.8
34 x 58.30	Hollow / Caps	06.3458.3
34 x 59.90	Hollow / Caps	06.3459.9
34 x 60.80	Hollow / 1 Cap	06.3460.8
34 x 60.90	Hollow / Caps	06.3460.9
34 x 61.00	Hollow / Caps	06.3461
34 x 62.00	-	06.3462
34 x 64.90	-	06.3464.9
34 x 66.00	Hollow / Caps	06.3466
35 x 62.00	-	06.3562
35 x 63.90	-	06.3563.9
35 x 64.70	Hollow / 1 Cap	06.3564.7
35 x 67.00	Hollow / Caps	06.3567
36 x 62.80	Hollow / 1 Cap	06.3662.8
36 x 71.00	-	06.3671
37 x 73.80	Hollow / 1 Cap	06.3773.8-2
40 x 65.00	Hollow / Caps	06.4065
40 x 73.80	Hollow / 1 Cap	06.4073.8

GAS GAS
HONDA
HUSQVARNA
KAWASAKI
KTM
SUZUKI
YAMAHA
DIRT BIKE SLEEVES
STREET BIKE SLEEVES
ACCESSORIES
TECHNICAL

L.A. SLEEVE offers a wide range of crankshaft roller bearings in various sizes and applications. Crankshaft bearings are only supplied by leading quality brands such as; KOYO, NTN, SKF.



Size (mm)	Remarks	Part No.
17 x 40 x 12	C3	6203C3
17 x 47 x 14	C3	6303C3
20 x 47 x 14	C3	6204C3
20 x 47 x 14	C4	6204C4
20 x 47 x 14	Grooved, with ring, C4 Fit	6204NR
20 x 52 x 15	C3	6304C3
20 x 52 x 15	C4	6304C4
20 x 52 x 15	-	6304JR2
22 x 50 x 14	C3	6222C3
22 x 50 x 14	C4	6222C4
22 x 52 x 15	-	6304/22
22 x 56 x 16	C3	6322X
22 x 56 x 16	C4	6322C4
25 x 52 x 15	C3	6205C3
25 x 52 x 15	C4	6205C4
25 x 52 x 15	Grooved, with ring	6205NR
25 x 52 x 15	Roller Bearing	NJ205
25 x 55 x 15	-	83A915
25 x 55 x 15	With pin	83A916C
25 x 55 x 18	Grooved, with pin	83B051D
25 x 56 x 16	-	SX04B10
25 x 62 x 16	Grooved, with ring & pin	6305R1
25 x 62 x 17	C3	6305C3
25 x 62 x 17	Grooved, with ring	6305NR
25 x 62 x 17	-	6305JR2
25 x 62 x 17	Grooved, with pin	83406
25 x 62 x 17	Pinned	83464A
28 x 58 x 16	C3	6228C3
28 x 68 x 18	C3	6328C3
28 x 68 x 18	C4	6328C4
28 x 68 x 18	-	830048-4
28 x 72 x 18	-	6328/72C4
28 x 72 x 18	-	B32872
30 x 62 x 16	C3	6206C3
30 x 62 x 16	C4	6206C4
30 x 62 x 16	Grooved, with ring	6206NR
30 x 62 x 16	Grooved, with ring, C4 Fit	6206NRC4
30 x 62 x 16	Pinned	6206PC3
30 x 62 x 16	-	6206RSI
30 x 62 x 16	-	830046-14
30 x 62 x 16	Roller Bearing	NJ206
30 x 62 x 16	Roller Bearing	NJ206ECP-1
30 x 62 x 16	Grooved, Roller Bearing	NJ206ECP-2
30 x 62 x 16	Grooved, Roller Bearing	NJ206ECP-3
30 x 62 x 20	-	62206
30 x 63 x 16	-	830046-20
30 x 64 x 16	O.D. Step	830046
30 x 72 x 16	O.D. Step	SX06C62

Size (mm)	Remarks	Part No.
30 x 72 x 18	-	6306R/3
30 x 72 x 19	C3	6306C3
30 x 72 x 19	Grooved, with ring	6306NR
30 x 72 x 19	Pinned	6306PC3
30 x 72 x 19	-	83C072C
30 x 72 x 19	-	SX06C42
30 x 72 x 19	Roller Bearing	NJ306C3
30 x 76 x 17.5	-	692C3
30 x 76 x 19	Grooved	SX06C84
30 x 76 x 19	Grooved	SX06C84CS
32 x 65 x 17	C3	6232C3
32 x 65 x 17	-	6232X2
35 x 72 x 17	C3	6207C3
35 x 72 x 17	C4	6207C4
35 x 72 x 17	Grooved, with ring	6207NR
35 x 72 x 17	Grooved, with ring, C4 Fit	6207NRC4
35 x 72 x 17	Grooved, with ring & pin	6207NRLT
35 x 72 x 17	Pinned	6207PC4
35 x 72 x 17	With 4mm pinhole	6207YR
35 x 72 x 17	With pin	6207-26JR
35 x 72 x 17	With pin	83A844A
35 x 72 x 17	Roller Bearing	NJ207ECS
35 x 72 x 17	Roller Bearing	NJ207ECP-1
35 x 72 x 17	Grooved	SX07E39
35 x 72 x 27	With pinhole & pin	5207-1LT
35 x 80 x 18	With pin	6307/18
35 x 80 x 18.5	-	SC07A08
35 x 80 x 21	C3	6307C3
35 x 80 x 21	Grooved, with ring	6307NR
35 x 80 x 21	With pin	83A948
39 x 58 x 16	Roller Bearing	8ENK/16
39 x 60 x 16	Roller Bearing	8ENK/60
39 x 65 x 18	Roller Bearing	8ENK
40 x 80 x 18	C3	6208C3
40 x 80 x 18	Grooved, with ring	6208NRC4
40 x 80 x 18	Grooved, with ring & pin	6208YR1LT
40 x 90 x 23	C3	6308C3
40 x 90 x 23	-	6308YA3
40 x 90 x 23	Grooved with ring	6308YR5

CRANKSHAFT OIL SEALS

(O.E.M. REPLACEMENT SEALS)



L.A. SLEEVE offers a wide variety of OEM and ProX crankshaft oil seals.
Oil Seals are primarily manufactured by OE factories in Japan.
Oil Seals are available in sets per model application or may be purchased individually.

OIL SEALS DIMENSION CHART



Size (mm)	Part No.
18 x 30 x 6	09283-18006
18 x 30 x 7	09283-18007
20 x 32 x 7	92105-166-004
20 x 35 x 8	92104-444-005
20 x 37 x 6	09283-20051
20 x 37 x 7	91205-KZ3-861
20 x 37 x 8	09283-20034
20 x 40 x 7	93102-20485
20 x 40 x 7	92049-1052
20 x 40 x 7	92049-1065
20 x 40 x 7	92049-1188
20 x 40 x 8	93102-20447
20 x 40 x 9	92049-1300
22 x 40 x 7	93102-22363
22 x 40 x 8	91206-GC4-711
23 x 57 x 7	41.2-23174
25 x 37 x 6	09283-25083
25 x 37 x 6	09283-25099
25 x 38 x 7	09283-25082
25 x 40 x 6	92049-1365
25 x 40 x 7	92049-1047
25 x 40 x 7	92049-1068
25 x 40 x 7	92049-1250
25 x 40 x 8	41.2-25098
25 x 40 x 8	93103-25125
25 x 40 x 8	93102-25258
25 x 40 x 10	93103-25108
25 x 42 x 6	93101-25M50
25 x 44 x 7	09283-25066
25 x 44 x 8	41.3-25012
25 x 44 x 8	93102-25331
25 x 45 x 7	92049-1051
25 x 48 x 8	93101-25M35
25 x 62 x 6	290-831-355
25 x 62 x 8	93102-25M38
26 x 47 x 7	09283-26015
27.8 x 55 x 10	93102-28004
28 x 38 x 9	09283-28025

Size (mm)	Part No.
28 x 40 x 8	93103-28011
28 x 40 x 8	09283-28007
28 x 45 x 8	91203-444-003
28 x 50 x 8	91202-HA2-771
28 x 52 x 8	09283-28024
28 x 56 x 8	91201-KE6-831
29 x 47 x 8	09289-29002
30 x 40 x 6	41.3-30069
30 x 40 x 7	09283-30061
30 x 40 x 7	92049-0030
30 x 44 x 8	93102-30008
30 x 45 x 8	91203-KS6-004
30 x 50 x 7	92050-057
30 x 55 x 10	93103-30150
30 x 62 x 6	290-831-990
30 x 62 x 7	290-830-748
30 x 62 x 9	92049-3006
30 x 62 x 10	92050-507
30 x 72 x 6	92049-3706
30 x 72 x 7	3240041
30 x 72 x 10	92049-3704
30 x 72 x 10	92049-3705
32 x 44 x 8	93103-32099
32 x 44 x 8	93103-32171
32 x 44 x 8	93103-32183
32 x 44 x 8	09289-32003
32 x 44 x 9	92049-1301
32 x 47 x 6	41.3-32037
32 x 48 x 7.5	41.1-KSE671
32 x 48 x 10	93103-32M01
32 x 62 x 5/7	41.3-32027
33 x 72 x 8.5	290-931-711
34 x 79 x 2	290-931-450
34.5 x 90 x 5	93101-36M61
34.5 x 90 x 5	93101-36M62
35 x 51 x 8	93103-35M03
35 x 68 x 8	93102-35M57
35 x 72 x 7	290-831-952

Size (mm)	Part No.
35 x 80 x 6	92049-3716
35 x 80 x 6	3240043
35 x 80 x 8	92049-3715
35 x 80 x 8	3240042
36 x 52 x 8	09283-36004
36 x 52 x 8	09283-36007
36 x 55 x 10	93103-36182
36 x 80 x 8	93102-36M33
36 x 80 x 8	93101-36M46
38 x 52 x 7	91201-MEB-671
38 x 52 x 8	09283-38018
38 x 52 x 8	09283-38021
38 x 58 x 11	91201-KA4-004
39 x 56 x 7	91202-MEB-671
39 x 56 x 7.5	91201-MEY-671
40 x 55 x 6	41.6-405560
40 x 55 x 10	93103-40091
40 x 62 x 10	93103-40077
40 x 72 x 10	290-830-638
40 x 80 x 7	290-931-280
45 x 87 x 6	290-931-750

GAS GAS
HONDA
HUSQVARNA
KAWASAKI
KTM
SUZUKI
YAMAHA
DIRT BIKE SLEEVES
STREET BIKE SLEEVES
ACCESSORIES
TECHNICAL



CRANKSHAFT OIL SEALS

(O.E.M. REPLACEMENT SEALS)

HONDA CRANKSHAFT OIL SEALS

Model DIRT	Year	Set Part No.	Seal No.1	Qty.	Seal No.2	Qty.
CR 80	1980-1982	42.1100	92105-166-004	1	91201-KE6-831	1
CR 80	1983-2002	42.1103	92105-166-004	1	91206-GC4-711	1
CR 85	2003-2007	42.1103	92105-166-004	1	91206-GC4-711	1
CR 125	1980-1985	42.1202	92104-444-005	1	91203-KS6-004	1
CR 125	1986-2007	42.1206	92105-166-004	1	91203-KS6-004	1
CRF 150 R	2007-2023	42.1207	41.1-KSE671	1	91201-MEB-671	1
CR 250	1981-1983	42.1301	91203-444-003	1	91201-KA4-004	1
CR 250	1984-1991	42.1304	92105-166-004	1	91201-KA4-004	1
CR 250	1992-2007	42.1312	91205-KZ3-861	1	91201-KA4-004	1
CRF 250 R	2004-2005	42.1402	91201-MEB-671	1	91202-MEB-671	1
CRF 250 R	2006-2017	42.1405	91201-MEB-671	1	91201-MEY-671	1
CRF 250 X	2004-2006	42.1402	91201-MEB-671	1	91202-MEB-671	1
CRF 250 X	2007-2017	42.1405	91201-MEB-671	1	91201-MEY-671	1
CRF 450 R	2002-2005	42.1402	91201-MEB-671	1	91202-MEB-671	1
CRF 450 R	2006-2016	42.1405	91201-MEB-671	1	91201-MEY-671	1
CRF 450 X	2005-2017	42.1405	91201-MEB-671	1	91201-MEY-671	1
CR 500	1984-2001	42.1304	92105-166-004	1	91201-KA4-004	1
Model ATV	Year	Set Part No.	Seal No.1	Qty.	Seal No.2	Qty.
ATC 250 R	1985-1986	42.1365	91202-HA2-771	1	91201-KA4-004	1
TRX 250 R	1986-1989	42.1365	91202-HA2-771	1	91201-KA4-004	1

KAWASAKI CRANKSHAFT OIL SEALS

Model DIRT	Year	Set Part No.	Seal No.1	Qty.	Seal No.2	Qty.
KX 60	1983-1984	42.4101	92049-1065	1	92049-1065	1
KX 60	1985-2004	42.4105	92049-1188	1	92049-1188	1
KX 65	2000-2023	42.4105	92049-1188	1	92049-1188	1
KX 80	1980	42.4100	92049-1250	1	92049-1250	1
KX 80	1981-1984	42.4101	92049-1065	1	92049-1065	1
KX 80	1985-2000	42.4105	92049-1188	1	92049-1188	1
KX 85	2001-2023	42.4105	92049-1188	1	92049-1188	1
KX 100	1998-2021	42.4105	92049-1188	1	92049-1188	1
KX 112	2022-2024	42.4105	92049-1188	1	92049-1188	1
KX 125	1980	42.4100	92049-1250	1	92049-1250	1
KX 125	1981	42.4201	92049-1068	1	92049-1068	1
KX 125	1982-1984	42.4101	92049-1065	1	92049-1065	1
KX 125	1985-1987	42.4205	92049-1052	1	92049-1052	1
KX 125	1988-2008	42.4208	92049-1300	1	92049-1301	1
KDX 175	1980-1981	42.4100	92049-1250	1	92049-1250	1
KDX 175	1982	42.4201	92049-1068	1	92049-1068	1
KDX 200	1983-1989	42.4201	92049-1068	1	92049-1068	1
KDX 200	1990-1991	42.4285	92049-1047	1	92049-1047	1
KDX 200	1992-2006	42.4288	92049-1365	1	92049-1365	1
KDX 220 R	1998-2005	42.4288	92049-1365	1	92049-1365	1
KDX 250	1980	42.4350	92049-1047	1	92049-1051	1

CRANKSHAFT OIL SEALS

(O.E.M. REPLACEMENT SEALS)



KAWASAKI CRANKSHAFT OIL SEALS (Continued)

Model DIRT	Year	Set Part No.	Seal No.1	Qty.	Seal No.2	Qty.		
KDX 250	1981-1994	42.4300	92049-1051	1	92049-1052	1		
KX 250	1980-2008	42.4300	92049-1051	1	92049-1052	1		
KX 250 F	2004-2020	-	92049-0030	1	-	-		
KX 500	1983-2004	42.4403	92050-057	1	92050-057	1		
Model ATV	Year	Set Part No.	Seal No.1	Qty.	Seal No.2	Qty.		
KXF 250 Tecate	1987-1988	42.4607	92049-1051	1	92049-1051	1		
Model PWC	Year	Set Part No.	Seal No.1	Qty.	Seal No.2	Qty.	Seal No.3	Qty.
JS 440	1976-1990	091572	92049-3006	1	92050-507	1	92050-507	1
JS 440	1991-1992	091576	92049-3006	1	92049-3006	1	92050-507	1
JS 550	1982-1990	091572	92049-3006	1	92050-507	1	92050-507	1
JS 550 SX	1991-1995	091576	92049-3006	1	92049-3006	1	92050-507	1
JS 650 SX	1987-1993	42.4505	92049-3706	1	92049-3705	1	92049-3705	1
JS 750 SX	1992-1995	42.4505	92049-3706	1	92049-3705	1	92049-3705	1
JS 750 SS	1995-1996	42.4505	92049-3706	1	92049-3705	1	92049-3705	1
JS 750 SXi	1995-1996	42.4505	92049-3706	1	92049-3705	1	92049-3705	1
JS 750 ZXi	1995-1997	42.4505	92049-3706	1	92049-3705	1	92049-3705	1
JS 750 SXi Pro	1998-2002	42.4505	92049-3706	1	92049-3705	1	92049-3705	1
800 SX-R	2003-2011	42.4505	92049-3706	1	92049-3705	1	92049-3705	1
JS 900 ZXi	1995-1997	42.4519	92049-3705	1	92049-3715	1	92049-3716	1
JS 900 STX	1997-2006	42.4519	92049-3705	1	92049-3715	1	92049-3716	1
JS 900 STS	2001-2002	42.4519	92049-3705	1	92049-3715	1	92049-3716	1
JS 1100 ZXi	1996-2003	42.4519	92049-3705	1	92049-3715	1	92049-3716	1
JS 1100 STX	1997-1999	42.4519	92049-3705	1	92049-3715	1	92049-3716	1
JS 1100 STX D.I.	2000-2003	42.4519	92049-3705	1	92049-3715	1	92049-3716	1
Ultra 130 D.I.	2001-2004	42.4519	92049-3705	1	92049-3715	1	92049-3716	1

SUZUKI CRANKSHAFT OIL SEALS

Model DIRT	Year	Set Part No.	Seal No.1	Qty.	Seal No.2	Qty.
RM 65	2003-2005	42.4105	92049-1188	1	92049-1188	1
RM 80	1989-1998	42.3109	09283-30061	1	09283-18006	1
RM 80	1999-2001	42.3219	09283-30061	1	09283-18007	1
RM 85	2002-2023	42.3219	09283-30061	1	09283-18007	1
RM 125	1986-1988	42.3206	09283-28007	1	09283-18006	1
RM 125	1989-1998	42.3109	09283-30061	1	09283-18006	1
RM 125	1999-2011	42.3219	09283-30061	1	09283-18007	1
RM 250	1994-1995	42.3314	09283-38018	1	09283-20051	1
RM 250	1996-1999	42.3316	09283-38018	1	09283-25083	1
RM 250	2000-2002	42.3320	09283-25099	1	09283-38021	1
RM 250	2003-2004	42.3323	09283-25099	1	09283-28024	1
RM 250	2005-2012	42.3325	09283-25099	1	09283-28025	1
RMX 250	1995-1998	42.3316	09283-38018	1	09283-25083	1
RM-Z 250	2004-2006	-	92049-0030	1	-	-
RM-Z 250	2007-2009	-	09283-30061	1	-	-
RM-Z 250	2010-2023	42.3340	09283-30061	1	41.3-30069	1



CRANKSHAFT OIL SEALS

(O.E.M. REPLACEMENT SEALS)

SUZUKI CRANKSHAFT OIL SEALS (Continued)

Model DIRT	Year	Set Part No.	Seal No.1	Qty.	Seal No.2	Qty.
RM-Z 450	2005-2007	-	09283-30061	1	-	-
RM-Z 450	2008-2023	42.3410	09283-30061	1	41.3-32037	1
RMX 450 Z	2010-2019	42.3410	09283-30061	1	41.3-32037	1
Model ATV	Year	Set Part No.	Seal No.1	Qty.	Seal No.2	Qty.
LT 80	All		09283-20034	1	09283-20034	1
LT 250	1987-1992	42.3350	09283-36004	1	09283-25082	1
LT 500	1987-1990	42.3350	09283-36004	1	09283-25082	1

YAMAHA CRANKSHAFT OIL SEALS

Model DIRT	Year	Set Part No.	Seal No.1	Qty.	Seal No.2	Qty.
PW 50	1981-2014	42.2005	41.2-17067	1	41.2-23174	1
PW 80	1983-2006	42.2008	41.2-25098	1	93103-32183	1
YZ 80	1982-2001	42.2102	93102-20447	1	93103-28011	1
YZ 85	2002-2018	42.2102	93102-20447	1	93103-28011	1
YZ 125	1977-1979	42.2200	93103-25125	1	93103-28011	1
YZ 125	1980-1985	42.2201	93102-25258	1	93103-28011	1
YZ 125	1986-1997	42.2206	93102-22363	1	93103-32099	1
YZ 125	1998-2000	42.2218	93102-22363	1	93103-32183	1
YZ 125	2001-2004	42.2221	93102-30008	1	93102-20485	1
YZ 125	2005-2023	42.2225	41.2-22419	1	93102-20485	1
YZ 250	1976-1987	42.2300	93103-30150	1	93103-40091	1
YZ 250	1988-1997	42.2308	93102-22363	1	93103-40091	1
YZ 250	1998	42.2318	93102-22363	1	93103-36182	1
YZ 250	1999-2000	42.2319	93102-20485	1	93103-36182	1
YZ 250	2001-2023	42.2321	93102-28004	1	93102-20485	1
WR 250	1989-1997	42.2308	93102-22363	1	93103-40091	1
YZ 465	1980-1981	42.2300	93103-30150	1	93103-40091	1
YZ 490	1982-1990	42.2300	93103-30150	1	93103-40091	1
Model ATV	Year	Set Part No.	Seal No.1	Qty.	Seal No.2	Qty.
YFS 200 Blaster	1988-2004	42.2281	93102-25331	1	93103-32171	1
YFS 200 Blaster	2005-2006	42.2285	41.2-25012	1	93103-32099	1
YFZ 350 Banshee	1987-2006	42.2020	93103-25108	1	93103-40077	1
Model STREET	Year	Set Part No.	Seal No.1	Qty.	Seal No.2	Qty.
DT 125 R	1988-2006	42.2280	93102-25331	1	93103-32099	1
TZR 125	-	42.2280	93102-25331	1	93103-32099	1
IT 125	1980-1981	42.2200	93103-25125	1	93103-28011	1
DT 125 R/X	2005-2006	42.2281	93102-25331	1	93103-32171	1
IT 175	1980-1983	42.2201	93102-25258	1	93103-28011	1
RD 350 LC-YPVS	-	42.2020	93103-25108	1	93103-40077	1

CRANKSHAFT OIL SEALS

(O.E.M. REPLACEMENT SEALS)



YAMAHA CRANKSHAFT OIL SEALS (Continued)

Model PWC	Year	Set Part No.	Seal No.1	Qty.	Seal No.2	Qty.	Seal No.3	Qty.
Superjet 650	1990-1993	42.2510	93103-32M01	1	93102-36M33	1	93101-36M46	1
Wave Runner 650	1990-1996	42.2510	93103-32M01	1	93102-36M33	1	93101-36M46	1
Superjet 700	1994-2014	42.2510	93103-32M01	1	93102-36M33	1	93101-36M46	1
Wave Blaster 700	1993-2004	42.2510	93103-32M01	1	93102-36M33	1	93101-36M46	1
Wave Raider 700	1994-1997	42.2510	93103-32M01	1	93102-36M33	1	93101-36M46	1
Wave Runner 700	1993-2004	42.2510	93103-32M01	1	93102-36M33	1	93101-36M46	1
Wave Venture 700	1995-2004	42.2510	93103-32M01	1	93102-36M33	1	93101-36M46	1
XL 700	1995-2005	42.2510	93103-32M01	1	93102-36M33	1	93101-36M46	1
GP 760	1996-2000	42.2510	93103-32M01	1	93102-36M33	1	93101-36M46	1
GP 800 R	1998-2005	42.2518	93103-35M03	1	93101-36M61	1	93101-36M62	1
XL 800	2000-2001	42.2518	93103-35M03	1	93101-36M61	1	93101-36M62	1
XLT 800	2002-2004	42.2518	93103-35M03	1	93101-36M61	1	93101-36M62	1
Wave Runner 1100	1995-1997	42.2510	93103-32M01	1	93102-36M33	1	93101-36M46	1
GP 1200	1997-1999	42.2510	93103-32M01	1	93102-36M33	1	93101-36M46	1
XL 1200	1997-1999	42.2510	93103-32M01	1	93102-36M33	1	93101-36M46	1
SUV 1200	1999-2004	42.2510	93103-32M01	1	93102-36M33	1	93101-36M46	1
XL 1200 LTD	1998-2001	42.2520	93102-35M57	1	93101-36M61	1	93101-36M62	1
GP 1200 R	2000-2003	42.2520	93102-35M57	1	93101-36M61	1	93101-36M62	1
XLT 1200	2001-2005	42.2520	93102-35M57	1	93101-36M61	1	93101-36M62	1

POLARIS CRANKSHAFT OIL SEALS

Model PWC	Year	Set Part No.	Seal No.1	Qty.	Seal No.2	Qty.	Seal No.3	Qty.
SL 650	1992-1995	42.6680	3240041	1	3240042	1	3240043	1
SL 750	1993-1995	42.6680	3240041	1	3240042	1	3240043	1
SLT 750	1993-1995	42.6680	3240041	1	3240042	1	3240043	1
SL 780	1995-1997	42.6680	3240041	1	3240042	1	3240043	1
SLT 780	1995-1997	42.6680	3240041	1	3240042	1	3240043	1

SEA-DOO CRANKSHAFT OIL SEALS

Model PWC	Year	Set Part No.	Seal No.1	Qty.	Seal No.2	Qty.	Seal No.3	Qty.	Seal No.4	Qty.
Sea-Doo 580	1988-1996	42.5506	290-831-952	1	290-830-748	1	290-831-990	1	290-831-355	1
Sea-Doo 650	1993-1995	42.5507	290-831-952	1	290-830-748	1	290-831-990	1	290-831-990	1
Sea-Doo 720	1995-2005	42.5507	290-831-952	1	290-830-748	1	290-831-990	1	290-831-990	1
Sea-Doo 785	1995-2005	42.5510	290-931-450	1	290-931-450	1	290-830-748	1	290-830-638	1
Sea-Doo 951	1997-2005	42.5515	93715	1	93715	1	290-931-711	1	290-931-750	1

GASGAS
HONDA
HUSQVARNA
KAWASAKI
KTM
SUZUKI
YAMAHA
DIRT BIKE SLEEVES
STREET BIKE SLEEVES
ACCESSORIES
TECHNICAL

PRO-X pistons are supplied with OEM replacement rings which are produced by leading Japanese manufacturers Teikoku (TP) or Riken (RIK).

HONDA MOTORCYCLE

Model	O.E.M. No.	Size / MM	Part No.
XR50R '00-03	13011-GBZ-702	Std. / 39mm	4060R
XR50R '00-03	13013-GEL-702	0.50 / 39.5mm	4062R
XR50R '00-03		1.00 / 40mm	4064R
XR50R '00-03		1.50 / 40.50	4066R
CRF-50F '04-24	13011-GBZ-702	Std. / 39mm	4060R
CRF-50F '04-24	13013-GEL-702	0.50 / 39.5mm	4062R
CRF-50F '04-24		1.00 / 40mm	4064R
CRF-50F '04-24		1.50 / 40.50	4066R
XR-70R '00-03	13011-GCF-A20	Std. / 47mm	4070R
XR-70R '00-03	13031-GCF-A20	0.50 / 47.5mm	4072R
XR-70R '00-03	13051-GCF-A20	1.00 / 48mm	4074R
XR-70R '00-03		1.50 / 48.5mm	4076R
XR-70R '00-03		2.00 / 49mm	4078R
CRF-70F '04-12	13011-GCF-A20	Std. / 47mm	4070R
CRF-70F '04-12	13031-GCF-A20	0.50 / 47.5mm	4072R
CRF-70F '04-12	13051-GCF-A20	1.00 / 48mm	4074R
CRF-70F '04-12		1.50 / 48.5mm	4076R
CRF-70F '04-12		2.00 / 49mm	4078R
CR-80R '86-02	13121-GBF-841	Std. / 47mm	4080R
CR-85R '03-07	13121-GBF-B41	Std. / 47.5mm	4082R
CR-125R '80-84	13011-466-305	Std. / 55.5mm	3425
CR-125R '85-86	13127-KA3-760	Std. / 54mm	2780
CR-125R '87-91	13121-KS6-831	Std. / 54mm	4210R
CR-125R '92-04	13121-KZ4-702	Std. / 54mm	4260R
CR-125R '05-07	13121-KSR-731	Std. / 54mm	4370R
CR-250R '84-85	130A1-KA4-003	Std. / 66mm	0797
CR-250R '84-85	130A2-KA4-003	0.25 / 66.25mm	0798
CR-250R '86-87	13122-KS7-315	Std. / 66.4mm	4031R
CR-250R '88-04	13011-KZ3-306	Std. / 66.4mm	4420R
CR-250R '05-07	13121-KSK-732	Std. / 66.4mm	1325R
XR-400R '96-04	13011-KCY-670	Std. / 85mm	2500R
CRF-450R '02-08	13011-MEB-670	Std. / 96mm	4090R
CRF-450X '05-17	13011-MEB-670	Std. / 96mm	4090R
CR-500R '84-01	13011-ML3-305	Std. / 89mm	4050
XR650R '00-07	13011-MBN-305	Std. / 100mm	4700R

HONDA ATV

Model	O.E.M. No.	Size / MM	Part No.
ATC-110 '81-85	13011-439-005	Std. / 52mm	NLA
ATC-110 '81-85	13021-439-005	0.25 / 52.25mm	2411R
ATC-110 '81-85	13031-439-005	0.50 / 52.5mm	2412R
ATC-110 '81-85		0.75 / 52.75mm	2413R
ATC-110 '81-85		1.00 / 53mm	2414R
ATC-110 '81-85		1.25 / 53.25mm	2415R
ATC-110 '81-85		1.50 / 53.5mm	2416R
ATC-185 '80-83	13011-427-000	Std. / 63mm	NLA
ATC-185 '80-83		0.75 / 63.75mm	2423R



HONDA ATV (Continued)

Model	O.E.M. No.	Size / MM	Part No.
ATC-185 '80-83		1.00 / 64mm	2424R
ATC-185 '80-83		1.25 / 64.25mm	2425R
ATC-185 '80-83		1.50 / 64.5mm	2426R
TRX-200 '90-91 TRX-200D '91-97	13011-HF1-670	Std. / 65mm	2450R
TRX-200 '90-91 TRX-200D '91-97	13021-HF1-670	0.25 / 65.25mm	2451R
TRX-200 '90-91 TRX-200D '91-97	13031-HF1-670	0.50 / 65.5mm	2452R
TRX-200 '90-91 TRX-200D '91-97	13041-HF1-670	0.75 / 65.75mm	2453R
TRX-200 '90-91 TRX-200D '91-97	13051-HF1-670	1.00 / 66mm	2454R
TRX-200 '90-91 TRX-200D '91-97		1.50 / 66.5mm	2456R
ATC-250ES, SX '85-87 TRX-250 '85-87 TRX-250X '87-88, '91-92	13011-HC4-306	Std. / 74mm	2470R
ATC-250ES, SX '85-87 TRX-250 '85-87 TRX-250X '87-88, '91-92	13021-HC4-306	0.25 / 74.25mm	2471R
ATC-250ES, SX '85-87 TRX-250 '85-87 TRX-250X '87-88, '91-92	13031-HC4-306	0.50 / 74.5mm	2472R
ATC-250ES, SX '85-87 TRX-250 '85-87 TRX-250X '87-88, '91-92	13041-HC4-306	0.75 / 74.75mm	2473R
ATC-250ES, SX '85-87 TRX-250 '85-87 TRX-250X '87-88, '91-92	13051-HC4-306	1.00 / 75mm	2474R
ATC-250ES, SX '85-87 TRX-250 '85-87 TRX-250X '87-88, '91-92		1.50 / 75.5mm	2476R

REPLACEMENT RINGS

FOR O.E.M. & PRO-X PISTONS



GASGAS
HONDA
HUSQVARNA
KAWASAKI
KTM
SUZUKI
YAMAHA
DIRT BIKE SLEEVES
STREET BIKE SLEEVES
ACCESSORIES
TECHNICAL

HONDA ATV (Continued)			
Model	O.E.M. No.	Size / MM	Part No.
TRX-250R '87-89 Two-Stroke	13011-HA2-003	Std. / 66mm	4320R
TRX-250R '87-89 Two-Stroke	13012-HA2-003	0.25 / 66.25mm	4321R
TRX-300FW '88-00	13011-HC4-306	Std. / 74mm	2470R
TRX-300FW '88-00	13021-HC4-306	0.25 / 74.25mm	2471R
TRX-300FW '88-00	13031-HC4-306	0.50 / 74.5mm	2472R
TRX-300FW '88-00	13041-HC4-306	0.75 / 74.75mm	2473R
TRX-300FW '88-00	13051-HC4-306	1.00 / 75mm	2474R
TRX-300FW '88-00		1.50 / 75.5mm	2476R
TRX-300EX, X '93-09	13011-HM3-672	Std. / 74mm	2490R
TRX-300EX, X '93-09	13021-HM3-672	0.25 / 74.25mm	2491R
TRX-300EX, X '93-09	13031-HM3-672	0.50 / 74.5mm	2492R
TRX-300EX, X '93-09	13041-HM3-672	0.75 / 74.75mm	2493R
TRX-300EX, X '93-09	13051-HM3-672	1.00 / 75mm	2494R
TRX-300EX, X '93-09		1.50 / 75.5mm	2496R
TRX-400FW '95-04	13011-HM7-004	Std. / 86mm	2660R
TRX-400FW '95-04	13031-HM7-004	0.50 / 86.5mm	2662R
TRX-400FW '95-04	13051-HM7-004	1.00 / 87mm	2664R
TRX-400EX, X '99-14	13011-KCY-670	Std. / 85mm	2500R
TRX-450R '04-05	13011-HP1-305	Std. / 94mm	2600R

KAWASAKI MOTORCYCLE			
Model	O.E.M. No.	Size / MM	Part No.
KX-60 '83-03	13008-5050	Std. / 43mm	4290R
KX-65 '00-23	13008-1199	Std. / 44.5mm	4309R
KX-80 '83-00	13008-1100	Std. / 48mm	4230R
KX-85 '01-13	13008-1200	Std. / 48.5mm	4281R
KX-125 '86-87	13003-1117	Std. / 56mm	4205R
KX-125 '90	13008-1301	Std. / 56mm	4208R
KX-125 '91	13008-1315	Std. / 56mm	4209R
KX-125 '92-94	13008-1318	Std. / 54mm	4292R
KX-125 '95-03	13003-1356	Std. / 54mm	4296R
KX-125 '04-05	13003-0020	Std. / 54mm	4296R
KDX-200 '89-06	13008-1116	Std. / 66mm	4310R
KX-250 '87-91	13008-1091	Std. / 67.4mm	4305R
KX-250 '92-96	13008-1141	Std. / 66.4mm	4307R
KX-250 '97-04	13008-1173	Std. / 66.4mm	4308R
KX-250 '05-07	13008-0013	Std. / 66.4mm	4315R
KDX-250 '91-94	13008-1091	Std. / 67.4mm	4305R
KX-500 '88-04	13008-1103	Std. / 86mm	4330R

KAWASAKI PWC			
Model	O.E.M. No.	Size / MM	Part No.
JS-550 SX '91-95	13025-3703	0.50 / 75.5MM	4662R
JS-550 SX '91-95	13027-3703	1.00 / 76MM	4664R
JS-650 Thru '96	13008-3701	Std. / 76mm	4470R
JS-650 Thru '96	13024-3701	0.25 / 76.25mm	4471R
JS-650 Thru '96	13025-3701	0.50 / 76.50	4472R
JS-650 Thru '96	13026-3701	0.75 / 76.75mm	4473R
JS-650 Thru '96		1.00 / 77mm	4474R

KAWASAKI PWC (Continued)			
Model	O.E.M. No.	Size / MM	Part No.
JS-650 Thru '96		1.50 / 77.5mm	4476R
JS-650 Thru '96		2.00 / 78mm	4478R
JS-750 '92-02	13008-3708	Std. / 80mm	4480R
JS-750 '92-02	13024-3706	0.25 / 80.25mm	4481R
JS-750 '92-02	13025-3706	0.50 / 80.50mm	4482R
JS-750 '92-02		0.75 / 80.75mm	4483R
JS-750 '92-02		1.00 / 81mm	4484R
JS-750 '92-02		1.25 / 81.25mm	4485R
800 SX-R '03-11	13008-3710	Std. / 82mm	4510R
800 SX-R '03-11	13024-3708	0.25 / 82.25mm	4511R
800 SX-R '03-11	13025-3708	0.50 / 82.5mm	4512R
800 SX-R '03-11		0.75 / 82.75mm	4513R
800 SX-R '03-11		1.00 / 83mm	4514R
JS-900 ZXi '95-97 JS-900 STX '97-06 JS-900 STS '01-02	13008-3709	Std. / 73mm	4500R
JS-900 ZXi '95-97 JS-900 STX '97-06 JS-900 STS '01-02	13024-3707	0.25 / 73.25mm	4501R
JS-900 ZXi '95-97 JS-900 STX '97-06 JS-900 STS '01-02	13025-3707	0.50 / 73.50mm	4502R
JS-900 ZXi '95-97 JS-900 STX '97-06 JS-900 STS '01-02		0.75 / 73.75mm	4503R
JS-900 ZXi '95-97 JS-900 STX '97-06 JS-900 STS '01-02		1.25 / 74.25mm	4505R
JS-1100 ZXi, STX '97-03	13008-3708	Std. / 80mm	4480R
JS-1100 ZXi, STX '97-03	13024-3706	0.25 / 80.25mm	4481R
JS-1100 ZXi, STX '97-03	13025-3706	0.50 / 80.50mm	4482R
JS-1100 ZXi, STX '97-03		0.75 / 80.75mm	4483R
JS-1100 ZXi, STX '97-03		1.00 / 81mm	4484R
JS-1100 ZXi, STX '97-03		1.25 / 81.25mm	4485R
JS-1100 ZXi, STX '97-03		1.50 / 81.5mm	4486R
JH-1200 Ultra 150 '99-05	13008-3708	Std. / 80mm	4480R
STX-R 1200 '02-05	13008-3708	Std. / 80mm	4480R

SUZUKI MOTORCYCLE			
Model	O.E.M. No.	Size / MM	Part No.
RM-60 '03	13008-5050	Std. / 43mm	4290R
RM-65 '03-06	13008-1199	Std. / 44.5mm	4309R
RM-80 '86-01	12141-02B70	Std. / 47.5mm	5080R
RM-80 '91-01	12141-02B70-025	0.25 / 47.75mm	5081R
RM-80 '91-01	12141-02B70-050	0.50 / 48mm	5082R
RM-80 '91-01	12141-02B70-075	0.75 / 48.25mm	5083R
RM-80 '91-01	12141-02B70-100	1.00 / 48.5mm	5084R
RM-80 '91-01		1.50 / 49mm	5086R
RM-80 '91-01		2.00 / 49.5mm	5088R
RM-85 '02-23	12141-03B00	Std. / 48mm	5090R
RM-125 '81-88	12140-14110	Std. / 54mm	2793
RM-125 '81-88	12140-14110-025	0.25 / 54.25mm	2794



REPLACEMENT RINGS

FOR O.E.M. & PRO-X PISTONS

SUZUKI MOTORCYCLE (Continued)

Model	O.E.M. No.	Size / MM	Part No.
RM-125 '81-88	12140-14110-050	0.50 / 54.5mm	2795
RM-125 '81-88	12140-14110-075	0.75 / 54.75mm	2796
RM-125 '81-88	12140-14110-100	1.00 / 55mm	2797
RM-125 '89-95	12141-27C10	Std. / 54mm	5020R
RM-125 '96-03	12141-36E01	Std. / 54mm	5050R
RM-125 '04-11	12141-36F00	Std. / 54mm	5050R
RM-250 '89-95	12141-28C10	Std. / 67mm	5070R
RM-250 '96-06	12141-37E02	Std. / 66.4mm	4420R
RM-250 '07-08	12141-37F00	Std. / 66.4mm	4420R
DR-Z400 '00-24	12140-29F00	Std. / 90mm	5220R
RM-Z450 '05-07	12140-35810	Std. / 95.5mm	5230R

SUZUKI ATV

Model	O.E.M. No.	Size / MM	Part No.
LT-Z400 '02-14	12140-35810	Std. / 95.5mm	5230R

YAMAHA MOTORCYCLE

Model	O.E.M. No.	Size / MM	Part No.
PW-50 All Years	260-11601-03-00	Std. / 40mm	7260R
PW-50 All Years	260-11601-13-00	0.25 / 40.25mm	7261R
PW-50 All Years	260-11601-23-00	0.50 / 40.5mm	7262R
PW-50 All Years		1.00 / 41mm	7264R
PW, BW-80 All Years	14N-11603-00-00	Std. / 47mm	7270R
PW, BW-80 All Years	14N-11605-00-00	0.50 / 47.4mm	7272R
PW, BW-80 All Years		1.00 / 48mm	7274R
YZ-80 '84-92	39K-11611-00-00	Std. / 48mm	2754
YZ-80 '93-01	43K-11611-00-00	Std. / 47mm	7109R
YZ-85 '02-23	5PA-11611-01-00	Std. / 47.5mm	2112R
YZ-125 '90-93	5X4-11611-02-00	Std. / 56mm	7210R
YZ-125 '94-01	4JY-11611-00-00	Std. / 54mm	7214R
YZ-125 '02-24	5NY-11611-00-00	Std. / 54mm	2222R
YZ-250 '83-90	56A-11601-00-00	Std. / 68mm	2648
YZ-250 '83-90	56A-11601-10-00	0.25 / 68.25mm	2650
YZ-250 '83-90	56A-11601-20-00	0.50 / 68.5mm	2651
YZ-250 '83-90	56A-11601-30-00	0.75 / 68.75mm	2652
YZ-250 '83-90	56A-11601-40-00	1.00 / 69mm	2653
YZ-250 '83-90		1.25 / 69.25mm	2654
YZ-250 '83-90		1.50 / 69.5mm	2655
YZ-250 '83-90		1.75 / 69.75mm	2637R
YZ-250 '83-90		2.00 / 70mm	2638R
YZ-250 '92-98	4JX-11603-00-00	Std. / 68mm	7080R
YZ-250 '99-24	5CU-11603-11-00	Std. / 66.4mm	4420R
XT-250 '08-23	4XV-11603-01-00	Std. / 74mm	7200R
YZ-400F '98-99 WR-400F '99-00	5BE-11603-00-00	Std. / 92mm	7140R
YZ-426F '00-02 WR-426F '01-02	5JG-11603-00-00	Std. / 95mm	7150R
YZ-450F '03-09 WR-450F '03-15	5JG-11603-00-00	Std. / 95mm	7150R
YZ-450F '10-19 YZ-450FX '16-20 WR-450F '16-20	33D-11603-00-00	Std. / 97mm	02.2240

YAMAHA MOTORCYCLE (Continued)

Model	O.E.M. No.	Size / MM	Part No.
XT-600 '84-96	34L-11610-10-00	0.25 / 95.25mm	7051R
XT-600 '84-96	34L-11610-20-00	0.50 / 95.5mm	7052R
XT-600 '84-96	34L-11610-30-00	0.75 / 95.75mm	7053R
XT-600 '84-96	34L-11610-40-00	1.00 / 96mm	7054R

YAMAHA ATV/UTV

Model	O.E.M. No.	Size / MM	Part No.
Blaster 200 '88-06	3JM-11601-00-00	Std. / 66mm	4170R
Blaster 200 '88-06	3JM-11601-10-00	0.25 / 66.25mm	4171R
Blaster 200 '88-06	3JM-11601-20-00	0.50 / 66.5mm	4172R
Blaster 200 '88-06	3JM-11601-30-00	0.75 / 66.75mm	4173R
Blaster 200 '88-06	3JM-11601-40-00	1.00 / 67mm	4174R
Blaster 200 '88-06		1.25 / 67.25mm	4175R
Blaster 200 '88-06		1.50 / 67.5mm	4176R
Blaster 200 '88-06		1.75 / 67.75mm	4177R
Blaster 200 '88-06		2.00 / 68mm	4178R
YFM-350 '87-14	4GB-11610-00-00	Std. / 83mm	4150R
YFM-350 '87-14	4GB-11610-10-00	0.25 / 83.25mm	4151R
YFM-350 '87-14	4GB-11610-20-00	0.50 / 83.5mm	4152R
YFM-350 '87-14	4GB-11610-30-00	0.75 / 83.75mm	4153R
YFM-350 '87-14	4GB-11610-40-00	1.00 / 84mm	4154R
YFM-350 '87-14	4GB-11610-60-00	1.50 / 84.5mm	4156R
Kodiak 400 '93-99 Big Bear 400 '00-12	4GB-11610-00-00	Std. / 83mm	4150R
Kodiak 400 '93-99 Big Bear 400 '00-12	4GB-11610-10-00	0.25 / 83.25mm	4151R
Kodiak 400 '93-99 Big Bear 400 '00-12	4GB-11610-20-00	0.50 / 83.5mm	4152R
Kodiak 400 '93-99 Big Bear 400 '00-12	4GB-11610-30-00	0.75 / 83.75mm	4153R
Kodiak 400 '93-99 Big Bear 400 '00-12	4GB-11610-40-00	1.00 / 84mm	4154R
Kodiak 400 '93-99 Big Bear 400 '00-12	4GB-11610-60-00	1.50 / 84.5mm	4156R
YFM-600 Grizzly '98-01	34L-11610-10-00	0.25 / 95.25mm	7051R
YFM-600 Grizzly '98-01	34L-11610-20-00	0.50 / 95.5mm	7052R
YFM-600 Grizzly '98-01	34L-11610-30-00	0.75 / 95.75mm	7053R
YFM-600 Grizzly '98-01	34L-11610-40-00	1.00 / 96mm	7054R
YFM-600 Grizzly '98-01		1.25 / 96.25mm	7055R
YFM-600 Grizzly '98-01		1.50 / 96.5mm	7056R
YFM-600 Grizzly '98-01		1.75 / 96.75mm	7057R
YFM-600 Grizzly '98-01		2.00 / 97mm	7058R
YFM-660R Raptor '01-06 Grizzly 660 '02-08 Rhino 660 '05-08	3YF-11610-00-00	Std. / 100mm	4670R
YFM-660R Raptor '01-06 Grizzly 660 '02-08 Rhino 660 '05-08	3YF-11610-20-00	0.50 / 100.5mm	4672R
YFM-660R Raptor '01-06 Grizzly 660 '02-08 Rhino 660 '05-08	3YF-11610-40-00	1.00 / 101mm	4674R

REPLACEMENT RINGS

FOR O.E.M. & PRO-X PISTONS



YAMAHA PWC			
Model	O.E.M. No.	Size / MM	Part No.
Super Jet 650 '90-93 Waverunner 650 '90-96	6M6-11601-10-00	0.25 / 77.25mm	7101R
Super Jet 650 '90-93 Waverunner 650 '90-96	6M6-11601-20-00	0.50 / 77.5mm	7102R
Super Jet 650 '90-93 Waverunner 650 '90-96	6M6-11601-30-00	0.75 / 77.75mm	7103R
Super Jet 650 '90-93 Waverunner 650 '90-96		1.25 / 78.25mm	7105R
Super Jet 650 '90-93 Waverunner 650 '90-96		1.50 / 78.5mm	7106R
700 Twin '93-20	61X-11603-01-00	Std. / 81mm	7090R
Super Jet 700 '94-20	61X-11604-01-00	0.25 / 81.25mm	7091R
Wave Blaster '93-97	61X-11605-01-00	0.50 / 81.5mm	7092R
Wave Raider '95-97	61X-11606-01-00	0.75 / 81.75mm	7093R
Wave Runner Pro VXR	61X-11607-01-00	1.00 / 82mm	7094R
Wave Runner III GP			
Wave Venture '95-98	61X	1.50 / 82.5mm	7096R
FX-700 '94-95	61X	2.00 / 83mm	7098R
XL-700 '99-05			
GP-760 Twin '96-00	64X-11603-00-00	Std. / 84mm	7110R
GP-760 Twin '96-00	64X-11603-10-00	0.25 / 84.25mm	7111R
GP-760 Twin '96-00	64X-11603-20-00	0.50 / 84.5mm	7112R
GP-760 Twin '96-00	64X-11603-30-00	0.75 / 84.75mm	7113R
GP-760 Twin '96-00	64X-11603-40-00	1.00 / 85mm	7114R
GP-800R '98-05 XL/XLT-800 '00-04	66E-11603-00-00	Std. / 80mm	7170R
Wave Raider 1100 Wave Venture 1100	61X-11603-01-00	Std. / 81mm	7090R
Wave Raider 1100 Wave Venture 1100	61X-11604-01-00	0.25 / 81.25mm	7091R
Wave Raider 1100 Wave Venture 1100	61X-11605-01-00	0.50 / 81.5mm	7092R
Wave Raider 1100 Wave Venture 1100	61X-11606-01-00	0.75 / 81.75mm	7093R
Wave Raider 1100 Wave Venture 1100	61X-11607-01-00	1.00 / 82mm	7094R
Wave Raider 1100 Wave Venture 1100	61X	1.50 / 82.5mm	7096R
Wave Raider 1100 Wave Venture 1100	61X	2.00 / 83mm	7098R

YAMAHA PWC (Continued)			
Model	O.E.M. No.	Size / MM	Part No.
GP-1200 '97-99 SUV 1200 '99-04	65U-11603-01-00	Std. / 84mm	7110R
GP-1200 '97-99 SUV 1200 '99-04	65U-11604-01-00	0.25 / 84.25mm	7111R
GP-1200 '97-99 SUV 1200 '99-04	65U-11605-01-00	0.50 / 84.5mm	7112R
GP-1200 '97-99 SUV 1200 '99-04	65U-11606-01-00	0.75 / 84.75mm	7113R
GP-1200 '97-99 SUV 1200 '99-04	65U-11607-01-00	1.00 / 85mm	7114R
GP-1200 '97-99 SUV 1200 '99-04	65U	1.50 / 85.5mm	7116R
GP-1200R '00-02 XL/XLT-1200 '99-05	66E-11603-00-00	Std. / 80mm	7170R
GP-1300R '03-08	60T-11603-00-00	Std. / 84mm	7190R
FX-140 '03-06	4XV-11603-01-00	Std. / 74mm	7200R
FX-140 '03-06	60E-11605-01-00	0.50 / 74.5mm	7202R
FX-140 '03-06	60E-11607-01-00	1.00 / 75mm	7204R
YAMAHA KART			
Model	O.E.M. No.	Size / MM	Part No.
KT-100	427-11611-05	0.05 / 52.05mm	02-2000-05
KT-100	427-11611-10	0.10 / 52.10mm	02-2000-10
KT-100	427-11611-15	0.15 / 52.15mm	02-2000-15
KT-100	427-11611-20	0.20 / 52.20mm	02-2000-20
KT-100	427-11611-25	0.25 / 52.25mm	02-2000-25
KT-100	427-11611-30	0.30 / 52.30mm	02-2000-30
KT-100	427-11611-35	0.35 / 52.35mm	02-2000-35
KT-100	427-11611-40	0.40 / 52.40mm	02-2000-40
KT-100	427-11611-45	0.45 / 52.45mm	02-2000-45
KT-100	427-11611-50	0.50 / 52.50mm	02-2000-50
KT-100	427-11611-55	0.55 / 52.55mm	02-2000-55
KT-100	427-11611-60	0.60 / 52.60mm	02-2000-60
KT-100	427-11611-65	0.65 / 52.65mm	02-2000-65
KT-100	427-11611-70	0.70 / 52.70mm	02-2000-70
KT-100	427-11611-75	0.75 / 52.75mm	02-2000-75
KT-100	427-11611-80	0.80 / 52.80mm	02-2000-80

GAS GAS
HONDA
HUSQVARNA
KAWASAKI
KTM
SUZUKI
YAMAHA
DIRT BIKE SLEEVES
STREET BIKE SLEEVES
ACCESSORIES
TECHNICAL



CYLINDER SLEEVE INSTALLATION PROCEDURES

GENERAL RULES FOR SLEEVE INSTALLATION

ALWAYS WAIT UNTIL THE SLEEVE ARRIVES BEFORE BEGINNING ANY MACHINE WORK. NEVER ASSUME THAT THE STATED MODEL AND YEAR OF THE CYLINDER IS CORRECT. ALWAYS CHECK TO SEE IF THE SLEEVE PORTS MATCH THE CYLINDER PORTS.

2-STROKE

These tips are intended to be a guide for installing sleeves into cylinders. There are always exceptions to the rule and care must be taken on special applications.

Step 1. The cylinder must be stripped of all removable parts: studs, bolts, manifolds, power valves, etc.

Step 2. The cylinder is bored out to accept the sleeve. When the sleeve is installed into an all aluminum cylinder, the interference fit is .004". When the sleeve is being installed into a cast iron cylinder bore, the interference fit is .002" to .003".

The interference fit is determined by measuring the outside diameter of the sleeve, then boring the cylinder diameter smaller than the sleeve.

The interference fit is a critical aspect of sleeve installation because this step insures that the sleeve does not move when in the cylinder. Also, proper interference fit is important for cylinder cooling purposes.

Installation of flanged type sleeves follow the same procedures, but the top of the cylinder must have a countersink to the correct depth to accept the flanged sleeve. Interference fit of .001" to .000" on the flange diameter is recommended.

Step 3. The cylinder is then heated in an oven between 400 degrees, up to 450° for an hour or more.

Do not use a torch or hot plate for this procedure. It is important that the cylinder heats uniformly.

Step 4. The cylinder is then removed from the oven and the sleeve will drop easily into the cylinder.

Turning the sleeve by hand to line up the ports is a common practice, or you can use a needle nose type device to align the ports.

You will have between five and ten seconds before the sleeve and cylinder lock up.

Step 5. The cylinder must then be put under a hydraulic press to keep the sleeve from rising while the cylinder is cooling.

Step 6. The ports of the sleeve must then be blended with the cylinder by using an assortment of hand grinding porting tools. Mismatched ports will cause some power loss to the engine.

Step 7. After the ports have been matched, the cylinder (sleeve) must be bored out and honed to insure proper piston clearance.

Measure your piston at the skirt to properly bore the sleeved cylinder to the correct bore size.

Next, hone your cylinder to the correct piston clearance. Finish hone with a 280 grit.

Properly sleeved cylinders can use the O.E.M. recommended piston clearance. When using aftermarket pistons, size the clearance using the manufacturer recommended specs.

If you have a doubt, add a half thousandth (.0005") to the clearance

Step 8. As an added finishing touch, surface decking the top of the cylinder is recommended in order to make sure that the head gasket will sit flat on the cylinder to create a good sealing surface. Make sure you only take the minimum cut off the top of the cylinder.

4-STROKE

Step 1. Determine which type of cylinder is to be sleeved.

- A. Original cylinder is alloy-chrome plated, Nikasil, or electrofused. The cylinder must be bored to accept the new cylinder sleeve.
- B. Original cylinder or block has a cast-in liner. Do not try to push out the cast-in liner. Cylinder damage will be the result. The cylinder must be bored to accept the new cylinder sleeve.
- C. Original barrel is cast iron. The cast iron cylinder will be bored out to accept the new sleeve.
- D. Original cylinder or block has a replacement sleeve. Heat the cylinder to remove the sleeve. Check the new sleeve outside diameter for proper fit, re-heat the cylinder to install the new cylinder sleeve.

Step 2. The cylinder is bored out to accept the sleeve. When the sleeve is installed into an all aluminum cylinder, the interference fit is .004". When the sleeve is being installed into a cast iron cylinder bore, the interference fit is .002" to .003".

The interference fit is determined by measuring the outside diameter of the sleeve, then boring the cylinder diameter smaller than the sleeve.

The interference fit is a critical aspect of sleeve installation because this step insures that the sleeve does not move when in the cylinder. Also, proper interference fit is important for cylinder cooling purposes.

Step 3. Installation of flanged type sleeves follow the same procedures, but the top of the cylinder must have a countersink to the correct depth to accept the flanged sleeve. An interference fit of .001" to .000" on the flange diameter is recommended.

Step 4. The cylinder is then heated in an oven between 400 degrees to 450 degrees for an hour or more. Do not use a torch or hot plate for this procedure. It is important that the cylinder heats uniformly.

Step 5. The cylinder is then removed from the oven and the sleeve will drop easily into the cylinder.

Turning the sleeve by hand to line up the bottom skirt cut-out (when required) is a common practice.

You will have between five and ten seconds before the sleeve and cylinder lock up.

Step 6. The cylinder must then be put under a hydraulic press to keep the sleeve from rising while the cylinder is cooling.

Step 7. The cylinder (sleeve) must be bored out and honed to insure proper piston clearance.

Measure your piston at the skirt to properly bore the sleeved cylinder to the correct bore size.

Next, hone your cylinder to the correct piston clearance. Finish hone with a 280 grit.

Properly sleeved cylinders can use the O.E.M. recommended piston clearance. When using aftermarket pistons, size the clearance using the manufacturer recommended specs.

If you have a doubt, add a half thousandth (.0005") to the clearance.

Step 8. As an added finishing touch, surface decking the top of the cylinder is recommended in order to make sure that the head gasket will sit flat on the cylinder to create a good sealing surface. Make sure you only take the minimum cut off the top of the cylinder.

Custom-made cylinder sleeves to your specifications are available from L.A. SLEEVE. Quantities from one sleeve to full production are gladly accepted.

In many instances catalog item sleeves that are on the shelf may be close in size to fulfill the requirements. Call our technical staff, we will be glad to assist you!

WHAT YOU NEED TO KNOW

The two most important elements of custom sleeve design are the size required and the material requirements. L.A. SLEEVE stocks an array of raw material sizes ranging from 1-3/4" (45mm) to 8" (200mm). Cylinder sleeves may be manufactured in different wall thicknesses within this range.

MATERIAL

There are three different materials that L.A. SLEEVE uses for custom sleeves. The first and most popular is the Moly 2000 chrome-moly iron. This material covers all applications from hi-performance to small engine. Moly 2000 iron is available in all sizes and is the material chosen for ninety percent of all sleeves made. Unless otherwise specified we make custom sleeves from this material.

The second material is ductile iron (also known as Nodular). This is a high tensile strength, air quenched iron material and is used for specific hi-performance applications, such as fuel blown motors. Sleeve availability is limited to a small range of available casting sizes.

The third material available is aluminum, A355 centrifugally spun or A6061-T651 aluminum. Sleeve sizes are very limited. Also, aluminum sleeves are only made for applications where plating is required.

SLEEVE DIMENSION

When designing a sleeve, you need to determine the wall thickness required. You may also design the sleeve using the inside diameter and outside diameter to produce the desired wall thickness.

The method to determine wall thickness is **O.D. minus I.D. divided by 2 = wall thickness.**

Next, determine the proper length.

Finally, if a flange is required, determine the flange outside diameter and flange length (also known as flange thickness).

Allow the inside diameter to be .030" undersize the actual finish bore size dimension. This will give the machine shop bore stock after the sleeve is installed into the cylinder or block.

Always note the actual finish bore size as a reference on the drawing or dimension spec sheet.

Some sleeve applications require the bore size to be finish honed to the exact size. L.A. SLEEVE is able to provide the sleeve bore with a sized finish hone. Please be specific when requesting this application.

ADDITIONAL CUSTOM MACHINING

Some custom sleeves may require O-Ring grooves, flange clearances, notches or radius cuts. L.A. SLEEVE will machine any of these requirements into the custom sleeve. Provide a detailed drawing of all required custom machining and dimensions for a quotation.

HOW TO ORDER

Choose one of the drawing templates that most closely matches your requirement. Fill in the requested dimensions and FAX or e-mail the drawing to L.A. SLEEVE for a quotation and delivery.

If you do not see a drawing that matches your requirement, simply provide your own drawing and we will quote the sleeve per your requirements. Or call direct for technical assistance in designing your custom sleeve. Our staff will be glad to help!



MANUFACTURING SERVICES

L.A. SLEEVE has been a leader in sleeve innovation, design and installation for more than sixty-five years. We supply sleeves to all facets of the engine building industry. OE engine manufacturers, production rebuilders, performance builders, and small engine repair shops all receive the same attention and courtesy. Look to us for your cylinder sleeve requirements and installation solutions.

L.A. SLEEVE offers full sleeve liner production capabilities for OEM and aftermarket production engine establishments. We also will manufacture a single 'made-to-print' custom sleeve to fulfill your specific requirement.

Engine rebuilders find they can rely on the quality of L.A. SLEEVE cylinder liners. Cylinder sleeves are manufactured from centrifugally-spun Moly 2000 iron alloy castings, which insure ease of installation and trouble free boring. This bore-able chrome-moly alloy contains alloys found in today's plated cylinders, but will never peel or flake.

L.A. SLEEVE's Moly 2000 cylinder sleeves feature superior tensile strength, transfer heat quickly and efficiently, insuring a dependable long life engine. Cylinder sleeves are also custom manufactured from various specialty iron or aluminum materials.

HOW TO ORDER A CUSTOM SLEEVE

Photocopy and FAX this custom sleeve form. Designate appropriate dimensions on the drawing and provide the information requested. L.A.SLEEVE will quote pricing and lead time by return FAX. Note that custom sleeve orders require a one-half deposit to initiate production.

CUSTOMER # _____ CONTACT _____ DATE _____

NAME _____

ADDRESS _____

CITY _____ STATE _____ ZIP _____

PHONE _____ FAX _____

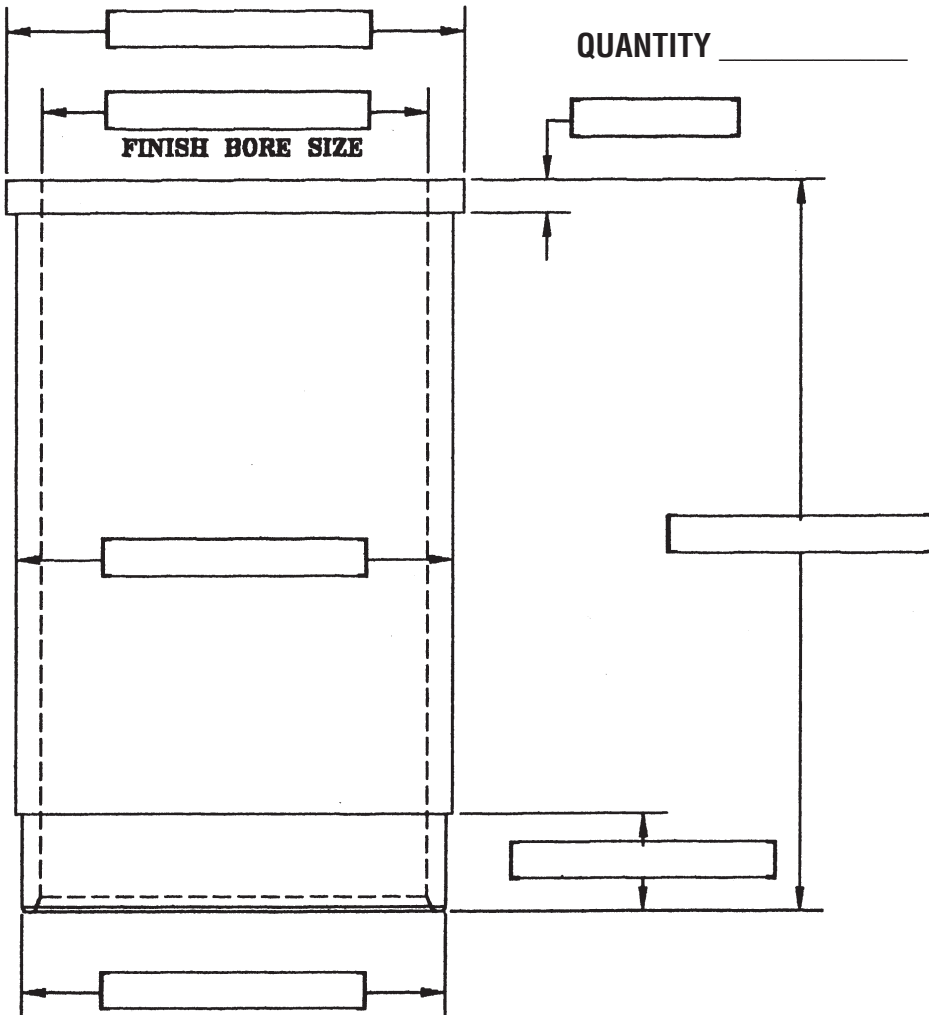

SHIP YOUR SAMPLE SLEEVE TO:
L.A.SLEEVE
CYLINDER DEPT.
 12051 RIVERA RD.
 SANTA FE SPRINGS, CA 90670

FAX TO:
(562) 698-7029

EMAIL TO:
info@lasleeve.com

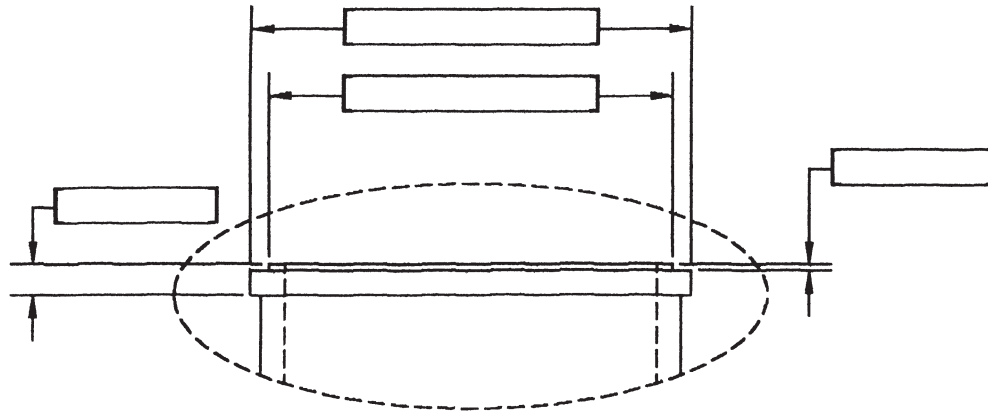

SPIGOT / FIRE RING

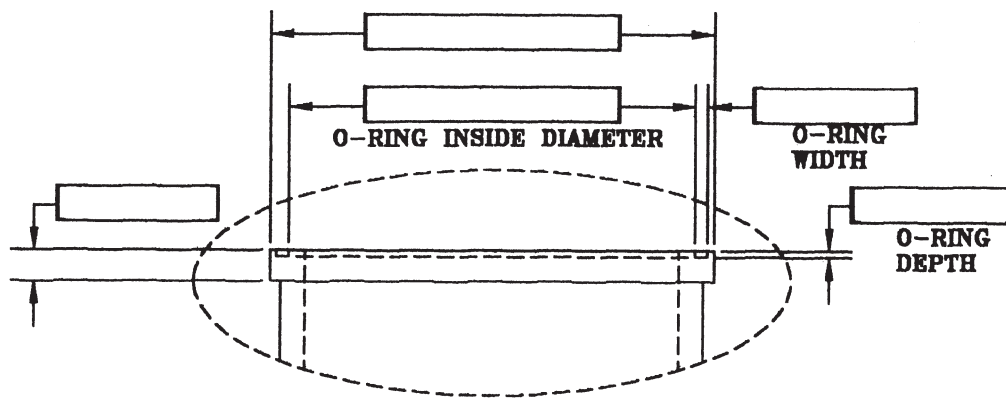

O-RING TYPE SLEEVE (IF APPLICABLE)

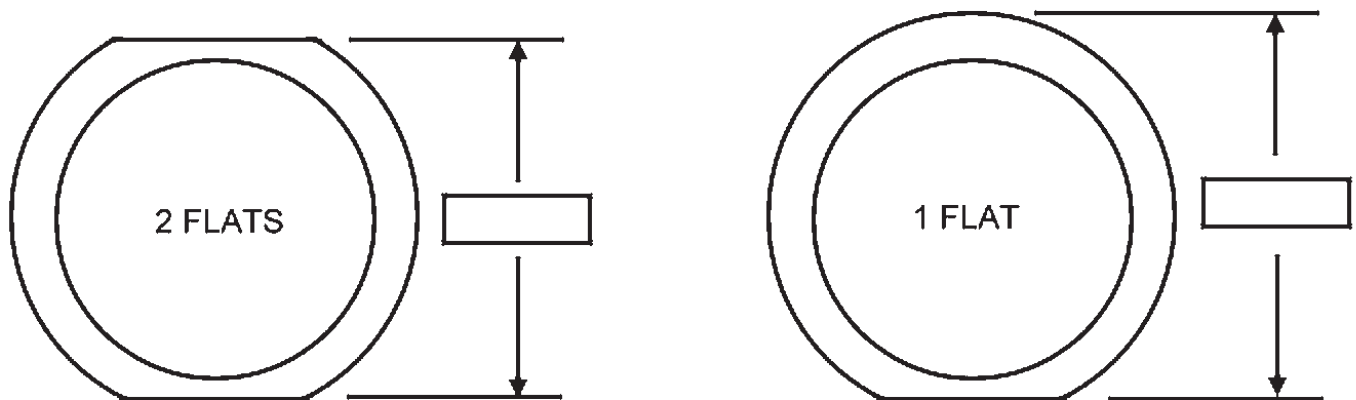

FLAT DIMENSIONS



2 STROKE CYLINDER DEPT. JOB ORDER FORM

MANUFACTURERS OF CYLINDER SLEEVES SINCE 1945 12051 RIVERA RD., SANTA FE SPRINGS, CA 90670 PHONE: 562-945-7578 • FAX: 562-698-7029

Cylinder sleeving includes installing our new sleeve into the cylinder, matching the ports to original specs, chamfering all port edges, boring and honing to fit the new piston. All modifications are done to your cylinder, unless otherwise specified. When sending your cylinder, remove all manifolds, studs, bolts, power valves, etc. **THERE IS A \$35.00 CHARGE TO REMOVE CYLINDER STUDS AND PV PARTS ON A STANDARD RESLEEVE JOB. ALSO, THERE IS AN ADDITIONAL \$35.00-\$90.00 CHARGE TO RE-INSTALL PV PARTS. L.A.SLEEVE IS NOT RESPONSIBLE FOR LOSS, DAMAGE OR REINSTALLATION OF PARTS.** Package your cylinder and/ or head upright in a sturdy box with plenty of paper and cardboard for padding. Include your piston if we are not supplying one. **A New Piston is necessary for Finish Hone.** Include this job order form with your cylinder. Dealers, if you do not have an L.A.SLEEVE customer number, include your business card. Allow three weeks plus shipping time.

CUSTOMER# _____ CONTACT _____ DATE _____ P.O. # _____
 COMPANY NAME _____ EMAIL _____
 ADDRESS _____ CITY _____
 STATE _____ ZIP _____ PHONE _____ FAX _____
 MAKE _____ MODEL _____ YEAR _____
 PARTS SENT IN BOX _____

REQUIRED SERVICES

PUT AN "X" IN BOX FOR EACH SERVICE OR ITEM REQUESTED:

- EXPEDITE JOB (ADD \$90.00 Call for availability)**
**EXPEDITE SERVICE NOT AVAILABLE FOR PORTING JOBS
- RESLEEVE TO STD. BORE
- RESLEEVE TO BIG BORE _____cc
- BORE TO NEXT AVAILABLE OVERSIZE PISTON
- MATCH NEW SLEEVE TO RACE PORTED CYLINDER (ADD'L \$175)
- NIKASIL CYLINDER
- HONE (DEGLAZE CYLINDER)
- MILL CYLINDER HEAD FOR BIG BORE
- MILL CYLINDER HEAD FOR HIGH COMPRESSION
- MACHINE POWER VALVE FOR BIG BORE
- REMOVE POWER VALVE & STUDS (Required) \$35
- REINSTALL POWER VALVE & STUDS(\$35-90)
*Additional Cleaning Fee May be Applied**
- BEAD BLAST CYLINDER / HEAD
- PURCHASE & SUPPLY NEW STUDS
- O-RING CYL. DECK
- EXTRACT BROKE STUD \$50-100 PER STUD
- HELICOIL- \$50 PER HOLE
- WELD CYLINDER

ADDITIONAL TOP END PARTS

- PISTON:
- TOP END GASKET
 - TOP END BEARING
 - COMPLETE GASKET SET

PORT CYLINDER FOR: (ADD'L \$350)

- WOODS
- MX
- DRAG RACE
- MILL HEAD (ADD'L \$125)
- REBUILD CRANKSHAFT
- PURCHASE CRANK
- PURCHASE BOTTOM END KIT
- MAIN BEARINGS
- MAIN SEALS
- ENGINE OIL SEALS

METHOD OF PAYMENT

- MONEY ORDER
- MASTERCARD / VISA / DISCOVER / AMEX

CARD NO. _____ EXP. _____
 NAME ON CARD _____ #CVV _____
 BILLING ADDRESS _____

RETURN UPS SHIPPING SERVICE:

- GROUND SERVICE
- 2ND DAY AIR
- NEXT DAY AIR
- 3-DAY GROUND SELECT

SHIP TO:
L.A.SLEEVE CYLINDER DEPT.
 12051 RIVERA RD., SANTA FE SPRINGS, CA 90670

COMMENTS OR ADDITIONAL REQUESTS:

4 STROKE CYLINDER DEPT. JOB ORDER FORM



MANUFACTURERS OF CYLINDER SLEEVES SINCE 1945 12051 RIVERA RD., SANTA FE SPRINGS, CA 90670 PHONE: 562-945-7578 • FAX: 562-698-7029

Cylinder sleeving includes installing our new sleeve into the cylinder, chamfering all edges, boring and honing to fit the new piston. All modifications are done to your cylinder, unless otherwise specified. When sending your cylinder, remove all manifolds, studs, bolts, chain tensioners, etc. **THERE IS A \$35.00 CHARGE TO REMOVE CYLINDER STUDS AND CAM CHAIN TENSIONER ON A STANDARD RESLEEVE JOB. L.A.SLEEVE IS NOT RESPONSIBLE FOR LOSS, DAMAGE OR REINSTALLATION OF PARTS.** Package your cylinder and/ or head upright in a sturdy box with plenty of paper and cardboard for padding. Include your piston if we are not supplying one. **A New Piston is necessary for Finish Hone.** Include this job order form with your cylinder. Dealers, if you do not have an L.A.SLEEVE customer number, include your business card. Allow three weeks plus shipping time.

CUSTOMER# _____ CONTACT _____ DATE _____ P.O. # _____
 COMPANY NAME _____ EMAIL _____
 ADDRESS _____ CITY _____
 STATE _____ ZIP _____ PHONE _____ FAX _____
 MAKE _____ MODEL _____ YEAR _____
 PARTS SENT IN BOX _____

REQUIRED SERVICES

PUT AN "X" IN BOX FOR EACH SERVICE OR ITEM REQUESTED:

- | | | |
|---|--|--|
| <input type="checkbox"/> EXPEDITE JOB (Add \$90.00 Call for availability)
**EXPEDITE SERVICE NOT AVAILABLE FOR PORTING JOBS | <input type="checkbox"/> PURCHASE & SUPPLY NEW STUDS | <input type="checkbox"/> RE-SHIM HEAD (shims incl.) |
| <input type="checkbox"/> RESLEEVE TO STD. BORE | <input type="checkbox"/> BORE CASE BB/STROKER (CIRCLE) | <input type="checkbox"/> EDM STUDS (CALL FOR PRICE QUOTE) |
| <input type="checkbox"/> RESLEEVE TO BIG BORE _____ CC | <input type="checkbox"/> O-RING CYL. DECK | <input type="checkbox"/> HELICOIL- \$50 PER HOLE |
| <input type="checkbox"/> BORE TO NEXT AVAILABLE OVERSIZE PISTON | FLOW PORT CYL. HEAD | <input type="checkbox"/> WELD CYLINDER / HEAD |
| <input type="checkbox"/> NIKASIL CYLINDER | <input type="checkbox"/> STD. VALVE JOB | <input type="checkbox"/> PURCHASE NEW TITANIUM VALVE |
| <input type="checkbox"/> HONE (DEGLAZE CYLINDER) | <input type="checkbox"/> RADIUS VALVE JOB | <input type="checkbox"/> PURCHASE NEW STAINLESS VALVE |
| <input type="checkbox"/> REMOVE STUDS (Required) \$35 | <input type="checkbox"/> RE-CUT VALVES | <input type="checkbox"/> PURCHASE HI-PERF. SPRING KIT |
| <input type="checkbox"/> BEAD BLAST CYLINDER / HEAD | <input type="checkbox"/> REPLACE VALVE GUIDES | <input type="checkbox"/> PURCHASE SHIM KIT |
| | <input type="checkbox"/> REPLACE VALVE SEAT | <input type="checkbox"/> PURCHASE SHIMS _____ # _____ QTY. |
| | | <input type="checkbox"/> CAM DEGREEING KIT |

ADDITIONAL TOP END PARTS

PISTON: _____ COMP. RATIO _____

TOP END GASKET
 COMPLETE GASKET SET
 CAM CHAIN

REBUILD CRANKSHAFT

- PURCHASE CRANK
 PURCHASE BOTTOM END KIT
 MAIN BEARINGS
 MAIN SEALS
 ENGINE OIL SEALS

METHOD OF PAYMENT

MONEY ORDER
 MASTERCARD / VISA / DISCOVER / AMEX
 CARD NO. _____ EXP. _____
 NAME ON CARD _____ #CVV _____
 BILLING ADDRESS _____

RETURN UPS SHIPPING SERVICE:

- GROUND SERVICE 2ND DAY AIR
 NEXT DAY AIR 3-DAY GROUND SELECT

SHIP TO:
L.A.SLEEVE CYLINDER DEPT.
 12051 RIVERA RD., SANTA FE SPRINGS, CA 90670

COMMENTS OR ADDITIONAL REQUESTS:



TERMS, CONDITIONS & POLICIES

BUSINESS HOURS: 8:00 a.m. to 5:00 p.m. Monday through Thursday, 8:00 a.m. to 4:30 p.m. Friday. Closed weekends and holidays.

MINIMUM ORDERS: A \$15.00 minimum applies to all orders.

PAYMENT: C.O.D., Credit/Debit on first order. Company check accepted after first order and receiving LASCO customer code number. No personal checks accepted. Dealers whose checks are returned for non-sufficient funds will be placed on a CASH-ONLY basis. Mastercard, VISA, Discover, American Express and PayPal.

PRICE CHANGES: Prices are subject to change without notice. Your invoice will show the current net price and should be reviewed upon receipt.

RETURNS: L.A. SLEEVE will not accept any returned goods without prior authorization. No returns accepted after 30 days. Returned merchandise must be accompanied by the following:

- A return authorization number (call for number). Display number on outside of carton.
- A copy of original invoice.
- A letter of explanation.

Merchandise must be returned freight prepaid. Shortages and discrepancies must be reported within ten days of invoice date. Refused orders and/or unwarranted returns shall be subject to a 25% restock handling charge, in addition to any incurred shipping charges. Credit will not be given on merchandise returned without a written explanation. Credit will be issued for returns that are accepted. No returns are allowed on gaskets, carburetors, jets and carb parts. No credit is given for returns that are not in original condition, or if any parts of a kit are missing.

FOREIGN COUNTRIES: Foreign orders are shipped on a prepaid basis unless prior arrangement is made with L.A. SLEEVE CO. Payment must be sent in U.S. funds, Foreign checks and currency are not accepted. Contact L.A. SLEEVE CO. by telephone or e-mail before sending payment to confirm current prices and shipping charges.

CYLINDER SLEEVING, BIG BORE KITS: Please allow two (2) weeks plus shipping time. All modifications are done to your cylinder unless otherwise specified. When sending your cylinder and parts, please remove all manifolds, studs, bolts, power valves, etc. We are not responsible for any lost parts. Package your cylinder and head upright in a sturdy box with plenty of paper and cardboard. Include your piston if we are not supplying one. Always include instructions inside the package, stating cylinder make, model and year, what work you want done, and if you want L.A. SLEEVE to provide the piston and a new gasket. Include your return address and phone number on the instruction sheet. Dealers, include a business card.

WE WILL NOT BEGIN ANY WORK WITHOUT WRITTEN INSTRUCTIONS.

LATE ORDERS: Dealers, please allow (ten) full working days before calling to check on orders that have not arrived. Much time is wasted looking up orders that have been shipped but that you have not allowed enough time for transit. Please cooperate with us on this. Do not use toll-free numbers when checking orders, call on (562) 945-7578. **DO NOT CALL COLLECT.** During peak seasons call your orders in early to assure delivery when you need it. Ordering Wednesday afternoon and requesting air shipping service will not always get your goods to you for the race on Saturday or Sunday.

SHIPPING: We ship all orders U.P.S. whenever possible. Second day air (Blue Label), next day air (Red Label), and 3-Day Select (Orange) services are available in addition to regular ground service. Parcel post and priority mail shipping is available also.

CHANGE OF ADDRESS: Please inform us of changes to your shipping or mailing address, telephone and e-mail address. This will ensure that you continue to receive good service from L.A. SLEEVE Co., and that we can provide you with updated information and catalogs.

LOS ANGELES SLEEVE CO., INC. LIMITED WARRANTY

Los Angeles Sleeve Co. warrants this product will be free from defects in material and workmanship for thirty (30) days following date of original purchase. If the product is found by LOS ANGELES SLEEVE CO. to be defective, such products will, at LOS ANGELES SLEEVE CO.'s option, be replaced or repaired at cost to LOS ANGELES SLEEVE CO. All products alleged by Purchaser to be defective must be returned to LOS ANGELES SLEEVE CO., postage prepaid, within the thirty (30) days warranty period.

THIS LIMITED WARRANTY DOES NOT COVER LABOR OR OTHER COSTS OR EXPENSES INCIDENTAL TO THE REPAIR AND/OR REPLACEMENT OF PRODUCTS OR PARTS.

This limited warranty does not apply to any products which has been subject to misuse, mishandling, misapplication, neglect (including but not limited to improper maintenance), accident, improper installation, modification (including but not limited to use of unauthorized parts or attachments), or adjustment or repair performed by anyone other than LOS ANGELES SLEEVE CO.

The parties hereto expressly agree that the Purchaser's sole and exclusive remedy against LOS ANGELES SLEEVE CO. shall be for the repair or replacement of the defective product as provided in this limited warranty. This exclusive remedy shall not be deemed to have failed of its essential purpose so long as LOS ANGELES SLEEVE CO. is willing and able to repair or replace defective goods.

THIS LIMITED WARRANTY IS IN LIEU OF ALL OTHER WARRANTIES, EXPRESS OR IMPLIED, INCLUDING THOSE OF MERCHANTABILITY OR FITNESS FOR A PARTICULAR PURPOSE NOT EXPRESSLY SET FORTH HEREIN. ANY PRODUCT WHICH MAY BE SOLD BY LOS ANGELES SLEEVE CO. BUT WHICH IS NOT MANUFACTURED BY LOS ANGELES SLEEVE CO. IS NOT WARRANTED BY LOS ANGELES SLEEVE

CO. BUT IS SOLD ONLY WITH THE WARRANTIES, IF ANY, OF THE MANUFACTURERS THEREOF.

LOS ANGELES SLEEVE CO.'S LIABILITY (WHETHER UNDER THE THEORIES OF BREACH OF CONTRACT OR WARRANTY, NEGLIGENCE OR STRICT LIABILITY) FOR ITS PRODUCTS SHALL BE LIMITED TO REPAIRING OR REPLACING PARTS FOUND BY LOS ANGELES SLEEVE CO. TO BE DEFECTIVE, OR AT LOS ANGELES SLEEVE CO.'S OPTION, TO REFUND THE PURCHASE PRICE OF SUCH PRODUCT. IN NO EVENT SHALL LOS ANGELES SLEEVE CO. BE LIABLE FOR INCIDENTAL OR CONSEQUENTIAL DAMAGES ARISING OUT OF OR IN CONNECTION WITH THE PRODUCT. CONSEQUENTIAL DAMAGES SHALL INCLUDE, WITHOUT LIMITATION, LOSS OF USE, INCOME OR PROFIT, OR LOSSES SUSTAINED AS THE RESULT OF INJURY (INCLUDING DEATH) TO ANY PERSON, OR LOSS OF OR DAMAGE TO PROPERTY.

Any claim by Purchaser regarding this product shall be deemed waived by the Purchaser unless submitted to LOS ANGELES SLEEVE CO. within the earlier of (i) fifteen (15) days following the date Purchaser discovered, or by reasonable inspection should have discovered, any claimed breach of this limited warranty, or (ii) thirty (30) days following the date of original purchase. Any cause of action for breach of this limited warranty shall be brought within six months from the date the alleged breach was discovered or should have been discovered, whichever occurs first.

Some states do not allow limitations on how long an implicit warranty lasts or the exclusion of incidental or consequential damages, so the above limitations or exclusions may not apply to you. This limited warranty gives you specific legal rights, and you may also have other rights which vary from state to state.

This photo: L.A. Sleeve Co. continues the day to day operations at their 35,000 square foot headquarters in Santa Fe Springs, CA.

HISTORICAL

LOS ANGELES SLEEVE CO. was founded in 1945 by family patriarch Nicholas W. Metchkoff. A family owned business for a lasting four generations, L.A. SLEEVE originated in a small Los Angeles factory. L.A. Sleeve began by producing cylinder sleeves for the automotive and tractor industries.

In 1950, Nicholas' son, Gary entered into the business as L.A. SLEEVE rapidly expanded into the world of automotive racing, and the heavy duty truck industry.

During the 1960's, L.A. SLEEVE exported cylinder sleeves worldwide and primarily to South America, thus establishing ourselves into the global economy. Beginning in 1968, L.A. SLEEVE entered the genesis of

the motorcycle market, which has grown to become the renowned power sports industry we know presently.

Today, L.A. SLEEVE manufactures superior quality cylinder sleeve liners for an assortment of industries. Automotive, heavy duty, industrial, motorcycle, ATV, snowmobile, and marine are the most prominent, but L.A. SLEEVE is not limited to these. We provide cylinder liners for original equipment manufacturers to a single custom sleeve. L.A. SLEEVE continues to be owned and operated by the third and fourth generation of the Metchkoff family. We are dedicated to uphold the family tradition of quality manufacturing, excellent service, and modern technology.

Photos Below, Top left: Early factory building circa 1945. Bottom left: October 1953. Bottom middle: Outside the new 5135 building in 1980. Far right: Founder Nicholas W. Metchkoff with son Gary.

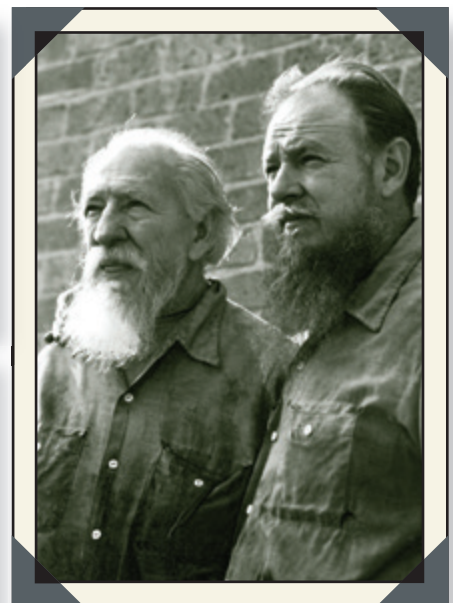



12051 Rivera Road, Santa Fe Springs, CA 90670
(562) 945-7578 | (800) 822-6005 | info@lasleeve.com
Website: www.lasleeve.com



REQUEST THESE CATALOGS:



Auto Performance Sleeve Catalog



Snowmobile Catalog



Marine Catalog



Unibat Battery Catalog